

LC717A10AJ

Capacitance-Digital-Converter LSI for Electrostatic Capacitive Touch Sensors

Overview

The LC717A10AJ is a high-performance and low-cost capacitance-digital-converter LSI for electrostatic capacitive touch sensor, especially focused on usability.

It has 16 channels capacitance-sensor input. This makes it ideal for use in the products that need many switches. Since the calibration function and the judgment of ON/OFF are automatically performed in LSI internal, it can make development time more short. A detection result (ON/OFF) for each input can be read out by the serial interface (I²C compatible bus or SPI).

Also, measurement value of each input can be read out as 8-bit digital data. Moreover, gain and other parameters can be adjusted using serial interface.

Features

- Detection System: Differential Capacitance Detection (Mutual Capacitance Type)
- Input Capacitance Resolution: Can Detect Capacitance Changes in the Femto Farad Order
- Measurement Interval (16 Differential Inputs):
 - ◆ 30 ms (Typ) (at Initial Configuration)
 - ◆ 6 ms (Typ) (at Minimum Interval Configuration)
- External Components for Measurement: Not Required
- Current Consumption:
 - ◆ 570 μ A (Typ) ($V_{DD} = 2.8$ V)
 - ◆ 1.3 mA (Typ) ($V_{DD} = 5.5$ V)
- Supply Voltage: 2.6 V to 5.5 V
- Detection Operations: Switch
- Interface: I²C Compatible Bus or SPI Selectable



ON Semiconductor®

www.onsemi.com

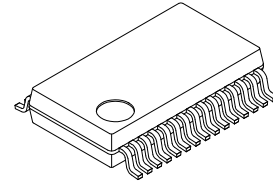

SSOP30 (225 mil)
CASE 565AZ

MARKING DIAGRAM

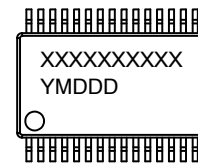

XXXXX = Specific Device Code
Y = Year
M = Month
DDD = Additional Traceability Data

ORDERING INFORMATION

See detailed ordering and shipping information on page 11 of this data sheet.

LC717A10AJ

Specifications

Table 1. ABSOLUTE MAXIMUM RATINGS ($T_A = 25^\circ\text{C}$, $V_{SS} = 0\text{ V}$)

Parameter	Symbol	Ratings	Unit	Remarks
Supply Voltage	V_{DD}	-0.3 to +6.5	V	
Input Voltage	V_{IN}	-0.3 to $V_{DD} + 0.3$	V	(Note 1)
Output Voltage	V_{OUT}	-0.3 to $V_{DD} + 0.3$	V	(Note 2)
Power Dissipation	$P_{d\max}$	160	mW	$T_A = +105^\circ\text{C}$, Mounted on a substrate (Note 3)
Storage Temperature	T_{stg}	-55 to +125	$^\circ\text{C}$	

Stresses exceeding those listed in the Maximum Ratings table may damage the device. If any of these limits are exceeded, device functionality should not be assumed, damage may occur and reliability may be affected.

1. Apply to C_{in0} to 15, C_{ref} , C_{refAdd} , $nRST$, SCL , SDA , $SA0$, $SA1$, SCK , SI , nCS .
2. Apply to C_{drv} , SDA , SO , $INTOUT$.
3. Single-layer glass epoxy board ($76.1 \times 114.3 \times 1.6\text{t mm}$).

Table 2. RECOMMENDED OPERATING CONDITIONS

Parameter	Symbol	Conditions	Min	Typ	Max	Unit	Remarks
Operating Supply Voltage	V_{DD}		2.6	-	5.5	V	
Supply Ripple + Noise	V_{PP}		-	-	± 20	mV	(Note 4)
Operating Temperature	T_{opr}		-40	25	105	$^\circ\text{C}$	

Functional operation above the stresses listed in the Recommended Operating Ranges is not implied. Extended exposure to stresses beyond the Recommended Operating Ranges limits may affect device reliability.

4. Inserting a high-valued capacitor and a low-valued capacitor in parallel between V_{DD} and V_{SS} is recommended. In this case, the small-valued capacitor should be at least $0.1\ \mu\text{F}$, and is mounted near the LSI.

Table 3. ELECTRICAL CHARACTERISTICS

($V_{SS} = 0\text{ V}$, $V_{DD} = 2.6$ to 5.5 V , $T_A = -40$ to $+105^\circ\text{C}$, Unless otherwise specified, the C_{drv} drive frequency is $f_{CDRV} = 143\text{ kHz}$.)

Not tested at low temperature before shipment.)

Parameter	Symbol	Conditions	Min	Typ	Max	Unit	Remarks
Capacitance Detection Resolution	N		-	-	8	bit	
Output Noise RMS	N_{RMS}	Minimum gain setting	-	-	± 1.0	LSB	(Notes 5, 7)
Input Offset Capacitance Adjustment Range	$C_{offRANGE}$		-	± 8.0	-	pF	(Notes 5, 7)
Input Offset Capacitance Adjustment Resolution	$C_{offRESO}$		-	8	-	bit	
C_{in} Offset Drift	$C_{inDRIFT}$	Minimum gain setting	-	-	± 8	LSB	(Note 5)
C_{in} Detection Sensitivity	$C_{inSENSE}$	Minimum gain setting	0.04	-	0.12	LSB/ff	(Note 6)
C_{in} Pin Leak Current	I_{Cin}	$C_{in} = \text{Hi-Z}$	-	± 25	± 500	nA	
C_{in} Allowable Parasitic Input Capacitance	C_{inSUB}	C_{in} against V_{SS}	-	-	30	pF	(Notes 5, 7)
C_{drv} Drive Frequency	f_{CDRV}		100	143	186	kHz	
C_{drv} Pin Leak Current	I_{CDRV}	$C_{drv} = \text{Hi-Z}$	-	± 25	± 500	nA	
$nRST$ Minimum Pulse Width	t_{NRST}		1	-	-	μs	
Power-on Reset Time	t_{POR}		-	-	20	ms	
Power-on Reset Operation Condition: Hold Time	t_{POROP}		10	-	-	ms	(Note 5)
Power-on Reset Operation Condition: Input Voltage	V_{POROP}		-	-	0.1	V	(Note 5)
Power-on Reset Operation Condition: Power Supply Rise Rate	t_{VDD}	0 V to V_{DD}	1	-	-	V/ms	(Note 5)

LC717A10AJ

Table 3. ELECTRICAL CHARACTERISTICS (continued)

($V_{SS} = 0\text{ V}$, $V_{DD} = 2.6\text{ to }5.5\text{ V}$, $T_A = -40\text{ to }+105^\circ\text{C}$, Unless otherwise specified, the Cdrv drive frequency is $f_{CDRV} = 143\text{ kHz}$. Not tested at low temperature before shipment.)

Parameter	Symbol	Conditions	Min	Typ	Max	Unit	Remarks
Pin Input Voltage	V_{IH}	High input	$0.8 V_{DD}$	-	-	V	(Notes 5, 8)
	V_{IL}	Low input	-	-	$0.2 V_{DD}$		
Pin Output Voltage	V_{OH}	High output ($I_{OH} = +3\text{ mA}$)	$0.8 V_{DD}$	-	-	V	(Note 9)
	V_{OL}	Low output ($I_{OL} = -3\text{ mA}$)	-	-	$0.2 V_{DD}$		
SDA Pin Output Voltage	$V_{OL} I^2C$	SDA Low output ($I_{OL} = -3\text{ mA}$)	-	-	0.4	V	
Pin Leak Current	I_{LEAK}		-	-	± 1	μA	(Note 10)
Current Consumption	I_{DD}	When initial setting and non-touch $V_{DD} = 2.8\text{ V}$	-	570	700	μA	(Notes 5, 7)
		When initial setting and non-touch $V_{DD} = 5.5\text{ V}$	-	1.3	1.6	mA	
	I_{STBY}	During Sleep process	-	-	1	μA	(Note 7)

Product parametric performance is indicated in the Electrical Characteristics for the listed test conditions, unless otherwise noted. Product performance may not be indicated by the Electrical Characteristics if operated under different conditions.

5. Design-guaranteed values (not tested before shipment).
6. Measurements conducted using the test mode in the LSI.
7. $T_A = +25^\circ\text{C}$.
8. Apply to nRST, SCL, SDA, SA0, SA1, SCK, SI, nCS.
9. Apply to Cdrv, SO, INTOUT.
10. Apply to nRST, SCL, SDA, SA0, SA1, SCK, SI, nCS.

LC717A10AJ

Table 4. I²C COMPATIBLE BUS TIMING CHARACTERISTICS

(V_{SS} = 0 V, V_{DD} = 2.6 to 5.5 V, T_A = -40 to +105°C, Not tested at low temperature before shipment.)

Parameter	Symbol	Pin Name	Conditions	Min	Typ	Max	Unit	Remarks
SCL Clock Frequency	f _{SCL}	SCL		–	–	400	kHz	
START Condition Hold Time	t _{HD;STA}	SCL, SDA		0.6	–	–	μs	
SCL Clock Low Period	t _{LOW}	SCL		1.3	–	–	μs	
SCL Clock High Period	t _{HIGH}	SCL		0.6	–	–	μs	
Repeated START Condition Setup Time	t _{SU;STA}	SCL, SDA		0.6	–	–	μs	(Note 11)
Data Hold Time	t _{HD;DAT}	SCL, SDA		0	–	0.9	μs	
Data Setup Time	t _{SU;DAT}	SCL, SDA		100	–	–	ns	(Note 11)
SDA, SCL Rise/Fall Time	t _r / t _f	SCL, SDA		–	–	300	ns	(Note 11)
STOP Condition Setup Time	t _{SU;STO}	SCL, SDA		0.6	–	–	μs	
STOP-to-START Bus Release Time	t _{BUF}	SCL, SDA		1.3	–	–	μs	(Note 11)

Product parametric performance is indicated in the Electrical Characteristics for the listed test conditions, unless otherwise noted. Product performance may not be indicated by the Electrical Characteristics if operated under different conditions.

11. Design-guaranteed values (not tested before shipment).

Table 5. SPI BUS TIMING CHARACTERISTICS

(V_{SS} = 0 V, V_{DD} = 2.6 to 5.5 V, T_A = -40 to +105°C, Not tested at low temperature before shipment.)

Parameter	Symbol	Pin Name	Conditions	Min	Typ	Max	Unit	Remarks
SCK Clock Frequency	f _{SCK}	SCK		–	–	5	MHz	
SCK Clock Low Time	t _{LOW}	SCK		90	–	–	ns	(Note 12)
SCK Clock High Time	t _{HIGH}	SCK		90	–	–	ns	(Note 12)
Input Signal Rise/Fall Time	t _r / t _f	nCS, SCK, SI		–	–	300	ns	(Note 12)
nCS Setup Time	t _{SU;NCS}	nCS, SCK		90	–	–	ns	(Note 12)
SCK Clock Setup Time	t _{SU;SCK}	nCS, SCK		90	–	–	ns	(Note 12)
Data Setup Time	t _{SU;SI}	SCK, SI		20	–	–	ns	(Note 12)
Data Hold Time	t _{HD;SI}	SCK, SI		30	–	–	ns	(Note 12)
nCS Hold Time	t _{HD;NCS}	nCS, SCK		90	–	–	ns	(Note 12)
SCK Clock Hold Time	t _{HD;SCK}	nCS, SCK		90	–	–	ns	(Note 12)
nCS Standby Pulse Width	t _{CPH}	nCS		90	–	–	ns	(Note 12)
Output High Impedance Time from nCS	t _{CHZ}	nCS, SO		–	–	80	ns	(Note 12)
Output Data Determination Time	t _v	SCK, SO		–	–	80	ns	(Note 12)
Output Data Hold Time	t _{HD;SO}	SCK, SO		0	–	–	ns	(Note 12)
Output Low Impedance Time from SCK Clock	t _{CLZ}	SCK, SO		0	–	–	ns	(Note 12)

Product parametric performance is indicated in the Electrical Characteristics for the listed test conditions, unless otherwise noted. Product performance may not be indicated by the Electrical Characteristics if operated under different conditions.

12. Design-guaranteed values (not tested before shipment).

LC717A10AJ

Power-On Reset (POR)

When power is turned on, power-on reset is enabled inside the LSI and its state is released after a certain power-on reset time, t_{POR} . Power-on reset operation condition: Power supply rise rate t_{VDD} must be at least 1 V/ms.

Since INTOUT pin changes from “High” to “Low” at the same time as the released of power-on reset, it is possible to verify the timing of release of power-on reset externally.

During power-on reset, C_{in} , C_{ref} and C_{refAdd} are unknown.

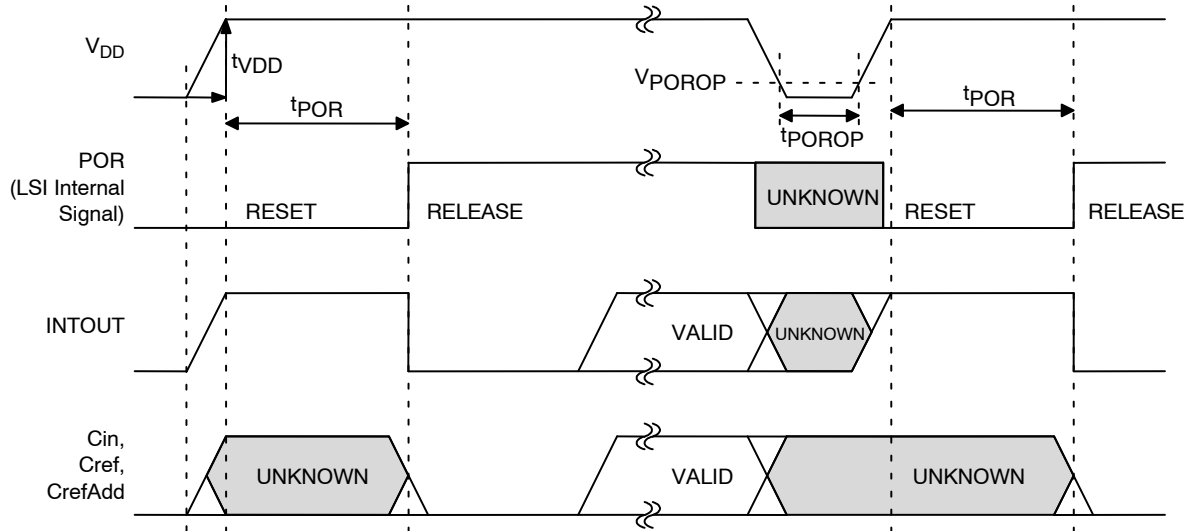

Figure 1.

I²C Compatible Bus Data Timing

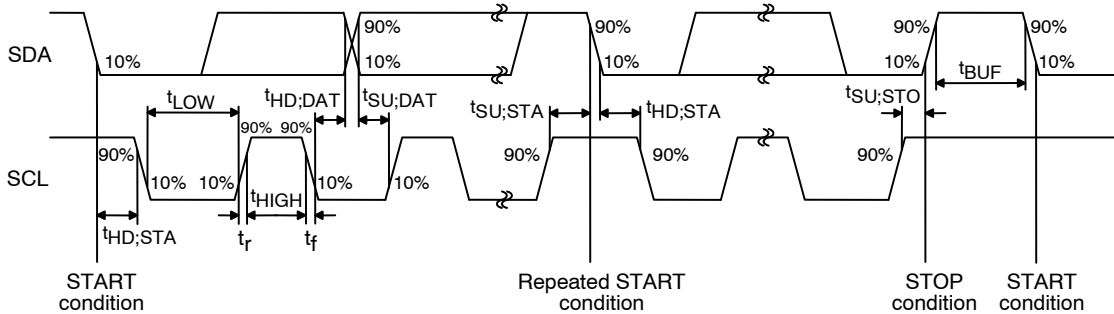

Figure 2.

I²C Compatible Bus Communication Formats

- Write format (data can be written into sequentially incremented addresses)



Figure 3.

- Read format (data can be read from sequentially incremented addresses)



Figure 4.

LC717A10AJ

I²C Compatible Bus Slave Address

Selection of four kinds of addresses is possible through the SA0 and SA1 terminals.

Table 6.

SA1 Pin Input	SA0 Pin Input	7-bit Slave Address	Binary Notation	8-bit Slave Address
Low	Low	0x16	00101100b (Write)	0x2C
			00101101b (Read)	0x2D
Low	High	0x17	00101110b (Write)	0x2E
			00101111b (Read)	0x2F
High	Low	0x18	00110000b (Write)	0x30
			00110001b (Read)	0x31
High	High	0x19	00110010b (Write)	0x32
			00110011b (Read)	0x33

SPI Data Timing (SPI Mode 0 / Mode 3)

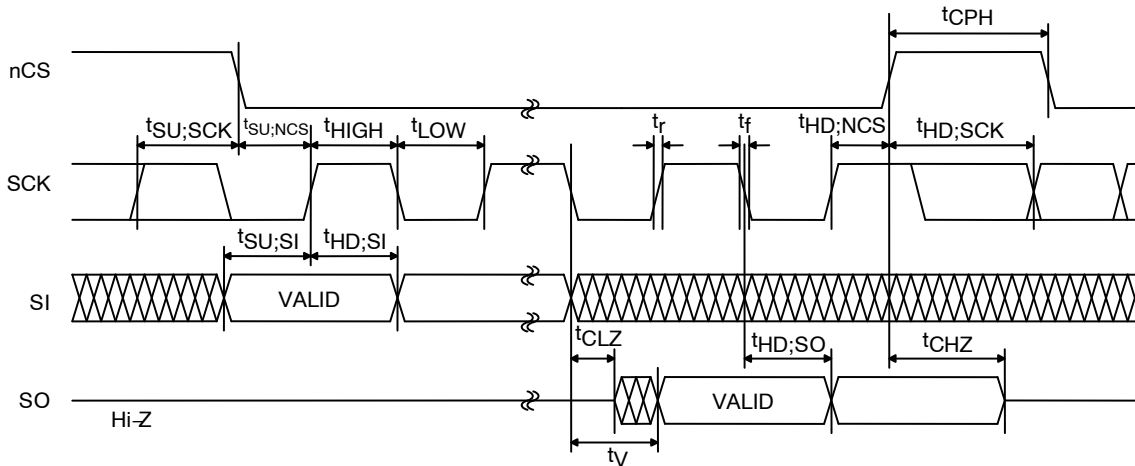

Figure 5.

SPI Communication Formats (Example of Mode 0)

- Write format (data can be written into sequentially incremented addresses while preserving nCS = L)

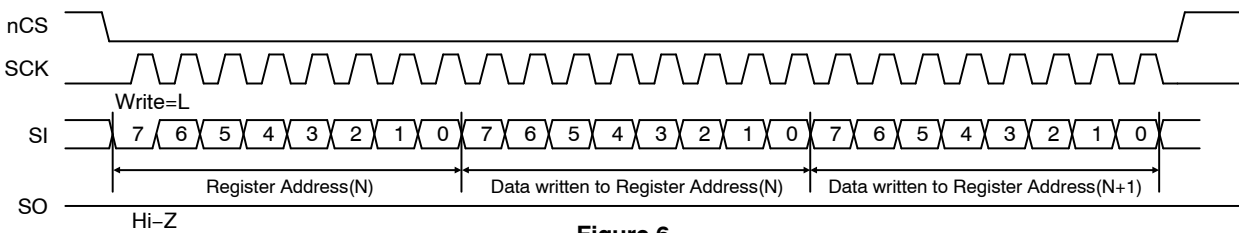

Figure 6.

- Read format (data can be read from sequentially incremented addresses while preserving nCS = L)

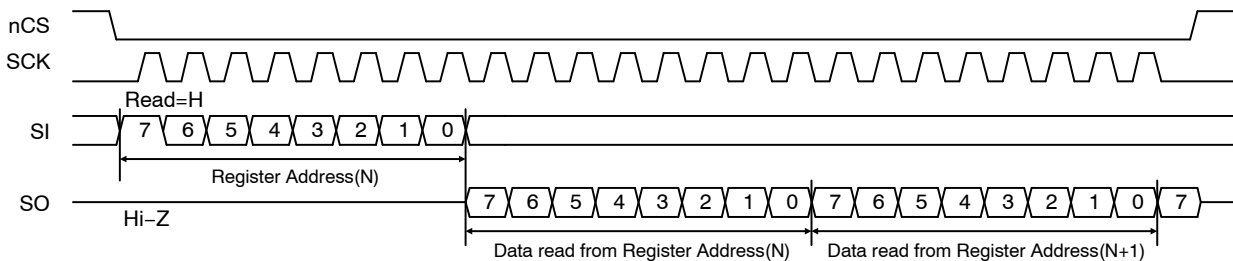

Figure 7.

LC717A10AJ

Block Diagram

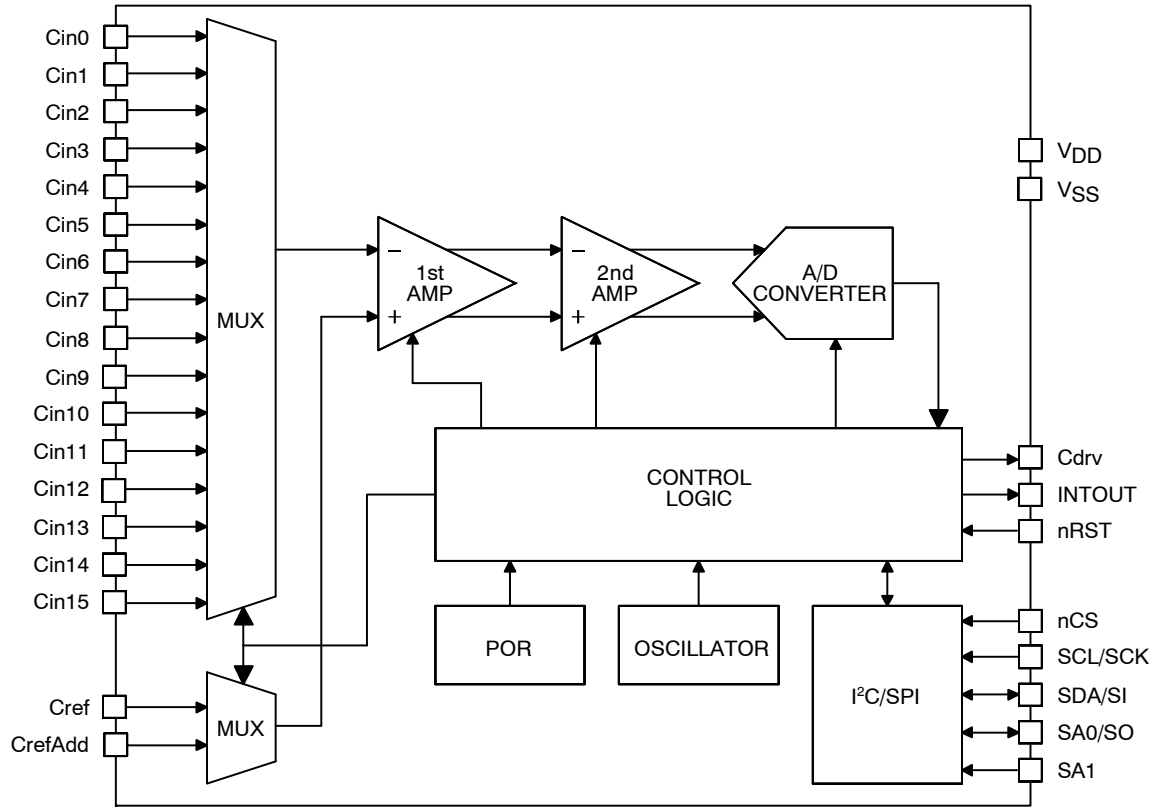

Figure 8. Simplified Block Diagram

LC717A10AJ is capacitance-digital-converter LSI capable of detecting changes in capacitance in the order of femto Farads. It consists of an oscillation circuit that generates the system clock, a power-on reset circuit that resets the system when the power is turned on, a multiplexer that selects the input channels, a two-stage amplifier that

detects the changes in the capacitance and outputs analog-amplitude values, a A/D converter that converts the analog-amplitude values into digital data, an I²C compatible bus or a SPI that enables serial communication with external devices and a control logic that controls the entire chip.

LC717A10AJ

Pin Assignment

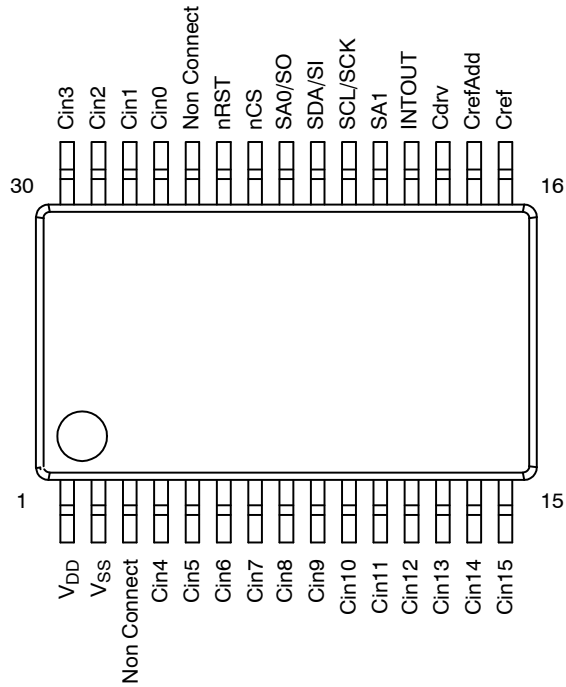

Figure 9. Pin Assignment (Top View)

Table 7. PIN ASSIGNMENT

Pin No.	Pin Name	Pin No.	Pin Name
1	V _{DD}	16	Cref
2	V _{SS}	17	CrefAdd
3	Non Connect (Note 13)	18	Cdrv
4	Cin4	19	INTOUT
5	Cin5	20	SA1
6	Cin6	21	SCL/SCK
7	Cin7	22	SDA/SI
8	Cin8	23	SA0/SO
9	Cin9	24	nCS
10	Cin10	25	nRST
11	Cin11	26	Non Connect (Note 13)
12	Cin12	27	Cin0
13	Cin13	28	Cin1
14	Cin14	29	Cin2
15	Cin15	30	Cin3

13. Connect to GND when mounted.

LC717A10AJ

Table 8. PIN FUNCTION

Pin Name	I/O	Pin Functions	Pin Type
Cin0	I/O	Capacitance sensor input	
Cin1	I/O	Capacitance sensor input	
Cin2	I/O	Capacitance sensor input	
Cin3	I/O	Capacitance sensor input	
Cin4	I/O	Capacitance sensor input	
Cin5	I/O	Capacitance sensor input	
Cin6	I/O	Capacitance sensor input	
Cin7	I/O	Capacitance sensor input	
Cin8	I/O	Capacitance sensor input	
Cin9	I/O	Capacitance sensor input	
Cin10	I/O	Capacitance sensor input	
Cin11	I/O	Capacitance sensor input	
Cin12	I/O	Capacitance sensor input	
Cin13	I/O	Capacitance sensor input	
Cin14	I/O	Capacitance sensor input	
Cin15	I/O	Capacitance sensor input	
Cref	I/O	Reference capacitance input	
CrefAdd	I/O	Reference capacitance input for addition	
Cdrv	O	Output for capacitance sensors drive	
INTOUT	O	Interrupt output	
SCL/SCK	I	Clock input (I ² C) / Clock input (SPI)	
nCS	I	Interface selection / Chip select inverting input (SPI)	
nRST	I	External reset signal inverting input	
SA1	I	Slave address selection (I ² C)	
SDA/SI	I/O	Data input and output (I ² C) / Data input (SPI)	

Table 8. PIN FUNCTION (continued)

Pin Name	I/O	Pin Functions	Pin Type
SA0/SO	I/O	Slave address selection (I ² C) / Data output (SPI)	
V _{DD}		Power supply (2.6 V to 5.5 V) (Note 14)	
V _{SS}		Ground (Earth) (Notes 14, 15)	

14. Inserting a high-valued capacitor and a low-valued capacitor in parallel between V_{DD} and V_{SS} is recommended. In this case, the small-valued capacitor should be at least 0.1 μF, and is mounted near the LSI.

15. When V_{SS} terminal is not grounded in battery-powered mobile equipment, detection sensitivity may be degraded.

Details of Pin Functions

Cin0 to Cin15

These are the capacitance-sensor-input pins. These pins are used by connecting them to the touch switch pattern. Cin and the Cdrv wire patterns should be close to each other. By doing so, Cdrv and Cin patterns are capacitively coupled. Therefore, LSI can detect capacitance change near each pattern as 8-bit digital data.

However, if the shape of each pattern or the capacitively coupled value of Cdrv is not appropriate, it may not be able to detect the capacitance change correctly.

In this LSI, there is a two-stage amplifier that detects the changes in the capacitance and outputs analog-amplitude values. Cin0 to Cin15 are connected to the inverting input of the 1st amplifier.

During measurement process, channels other than the one being measured are all in “Low” condition.

Leave the unused terminals open.

Cref, CrefAdd

These are the reference-capacitance-input pins. These are used by connecting to the wire pattern like Cin pins or are used by connecting any capacitance between this pin and Cdrv pin.

In this LSI, there is a two-stage amplifier that detects the changes in the capacitance and outputs analog-amplitude values. Cref is connected to the non-inverting input of the 1st amplifier.

Due to the parasitic capacitance generated in the wire connections of Cin pins and their patterns, as well as the one generated between the wire patterns of Cin and Cdrv pins, Cref may not detect capacitance change of each Cin pin accurately. In this case, connect an appropriate capacitance between Cref and Cdrv to detect capacitance change accurately.

However, if the difference between the parasitic capacitance of each Cin pin is extremely large, it may not detect capacitance change in each Cin pin correctly.

CrefAdd can be used as additional terminal for Cref. Leave the CrefAdd open if not in used.

Cdrv

It is the output pin for capacitance sensors drive. It outputs the pulse voltage which is needed to detect capacitance at Cin0 to Cin15.

Cdrv and Cin wire patterns should be close to each other so that they are capacitively coupled.

INTOUT

It is the interrupt-output pin. It is used by connecting to a main microcomputer if necessary, and use as interrupt signal. (High Active).

Leave the terminal open if not in used.

SCL/SCK

Clock input (I²C)/Clock input (SPI). It is the clock input pin of the I²C compatible bus or the SPI depending on the mode of operation.

nCS

Interface selection/Chip-select-inverting input (SPI). Selection of I²C compatible bus mode or SPI mode is through this terminal. After initialization, the LSI is automatically in I²C compatible bus mode. To continually use I²C compatible bus mode, fix nCS pin to “High”. To switch to SPI mode after LSI initialization, change the nCS input “High” → “Low”. The nCS pin is used as the chip-select-inverting input pin of SPI, and SPI mode is kept until LSI is again initialized.

LC717A10AJ

nRST

It is the external-reset-signal-inverting-input pin. When nRST pin is “Low”, LSI is in the reset state.

Each pin (Cin0 to 15, Cref, CrefAdd) is “Hi-Z” during reset state.

SDA/SI

Data input and output (I²C)/Data input (SPI). It is the data input and output pin of the I²C compatible bus or the data input pin of the SPI depending on the mode of operation.

SA0/SO

Slave address selection (I²C)/Data output (SPI). It is the slave address selection pin of the I²C compatible bus or the data output pin of the SPI depending on the mode of operation.

SA1

Slave address selection (I²C). It is the slave address selection pin of the I²C compatible bus.

When SPI mode, connect to the SA1 pin to GND.

Table 9. ORDERING INFORMATION

Device	Package	Shipping (Qty / Packing) [†]
LC717A10AJ-AH	SSOP30 (225 mil) (Pb-Free / Halogen Free)	1000 / Tape & Reel

[†]For information on tape and reel specifications, including part orientation and tape sizes, please refer to our Tape and Reel Packaging Specifications Brochure, [BRD8011/D](#).

MECHANICAL CASE OUTLINE
PACKAGE DIMENSIONS

ON Semiconductor®



SSOP30 (225 mil)
CASE 565AZ
ISSUE A

DATE 25 OCT 2013

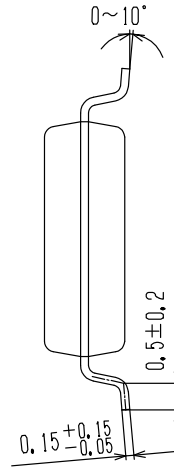
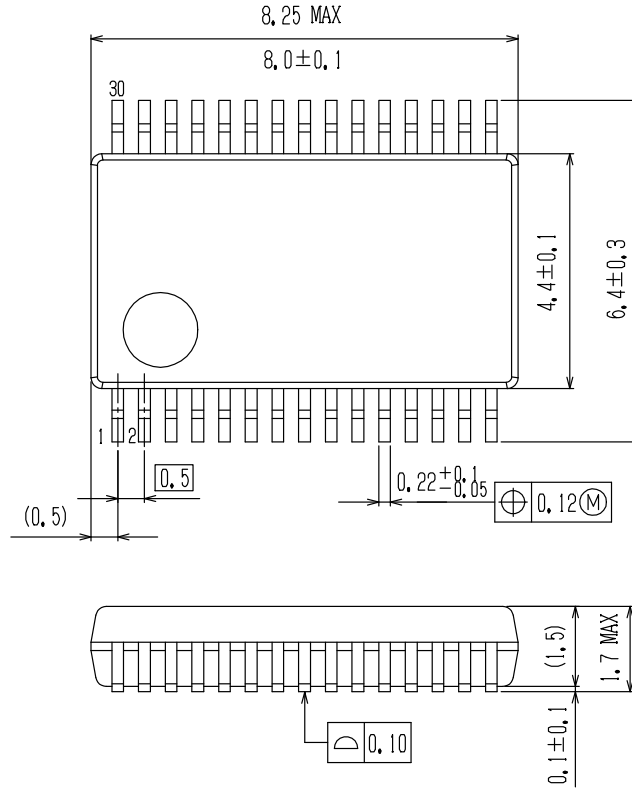
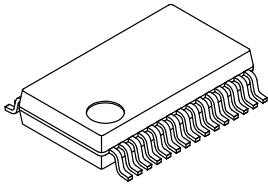

SOLDERING FOOTPRINT*

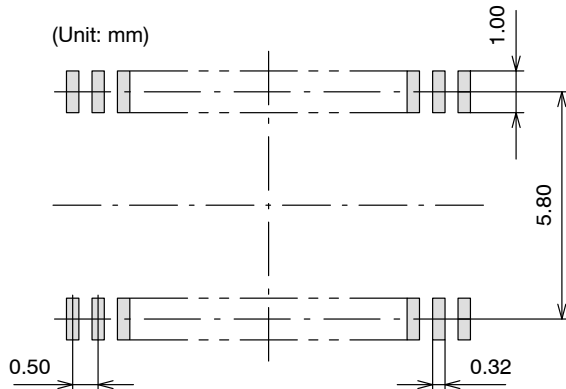

GENERIC MARKING DIAGRAM*

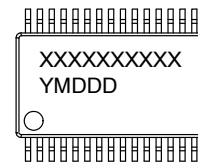

XXXXX = Specific Device Code
 Y = Year
 M = Month
 DDD = Additional Traceability Data

NOTE: The measurements are not to guarantee but for reference only.

*For additional information on our Pb-Free strategy and soldering details, please download the ON Semiconductor Soldering and Mounting Techniques Reference Manual, SOLDERRM/D.

*This information is generic. Please refer to device data sheet for actual part marking. Pb-Free indicator, "G" or microdot "▪", may or may not be present.

DOCUMENT NUMBER:	98AON80824E	Electronic versions are uncontrolled except when accessed directly from the Document Repository. Printed versions are uncontrolled except when stamped "CONTROLLED COPY" in red.
STATUS:	ON SEMICONDUCTOR STANDARD	
NEW STANDARD:		
DESCRIPTION:	SSOP30 (225 MIL)	PAGE 1 OF 2



ISSUE	REVISION	DATE
O	RELEASED FOR PRODUCTION FROM SANYO ENACT # S-526 TO ON SEMICONDUCTOR. REQ. BY D. TRUHITTE.	31 MAY 2012
A	ADDED MARKING AND SOLDER FOOTPRINT INFORMATION. REQ. BY D. TRUHITTE	25 OCT 2013

ON Semiconductor and  are registered trademarks of Semiconductor Components Industries, LLC (SCILLC). SCILLC reserves the right to make changes without further notice to any products herein. SCILLC makes no warranty, representation or guarantee regarding the suitability of its products for any particular purpose, nor does SCILLC assume any liability arising out of the application or use of any product or circuit, and specifically disclaims any and all liability, including without limitation special, consequential or incidental damages. "Typical" parameters which may be provided in SCILLC data sheets and/or specifications can and do vary in different applications and actual performance may vary over time. All operating parameters, including "Typicals" must be validated for each customer application by customer's technical experts. SCILLC does not convey any license under its patent rights nor the rights of others. SCILLC products are not designed, intended, or authorized for use as components in systems intended for surgical implant into the body, or other applications intended to support or sustain life, or for any other application in which the failure of the SCILLC product could create a situation where personal injury or death may occur. Should Buyer purchase or use SCILLC products for any such unintended or unauthorized application, Buyer shall indemnify and hold SCILLC and its officers, employees, subsidiaries, affiliates, and distributors harmless against all claims, costs, damages, and expenses, and reasonable attorney fees arising out of, directly or indirectly, any claim of personal injury or death associated with such unintended or unauthorized use, even if such claim alleges that SCILLC was negligent regarding the design or manufacture of the part. SCILLC is an Equal Opportunity/Affirmative Action Employer. This literature is subject to all applicable copyright laws and is not for resale in any manner.

ON Semiconductor and  are trademarks of Semiconductor Components Industries, LLC dba ON Semiconductor or its subsidiaries in the United States and/or other countries. ON Semiconductor owns the rights to a number of patents, trademarks, copyrights, trade secrets, and other intellectual property. A listing of ON Semiconductor's product/patent coverage may be accessed at www.onsemi.com/site/pdf/Patent-Marking.pdf. ON Semiconductor reserves the right to make changes without further notice to any products herein. ON Semiconductor makes no warranty, representation or guarantee regarding the suitability of its products for any particular purpose, nor does ON Semiconductor assume any liability arising out of the application or use of any product or circuit, and specifically disclaims any and all liability, including without limitation special, consequential or incidental damages. Buyer is responsible for its products and applications using ON Semiconductor products, including compliance with all laws, regulations and safety requirements or standards, regardless of any support or applications information provided by ON Semiconductor. "Typical" parameters which may be provided in ON Semiconductor data sheets and/or specifications can and do vary in different applications and actual performance may vary over time. All operating parameters, including "Typicals" must be validated for each customer application by customer's technical experts. ON Semiconductor does not convey any license under its patent rights nor the rights of others. ON Semiconductor products are not designed, intended, or authorized for use as a critical component in life support systems or any FDA Class 3 medical devices or medical devices with a same or similar classification in a foreign jurisdiction or any devices intended for implantation in the human body. Should Buyer purchase or use ON Semiconductor products for any such unintended or unauthorized application, Buyer shall indemnify and hold ON Semiconductor and its officers, employees, subsidiaries, affiliates, and distributors harmless against all claims, costs, damages, and expenses, and reasonable attorney fees arising out of, directly or indirectly, any claim of personal injury or death associated with such unintended or unauthorized use, even if such claim alleges that ON Semiconductor was negligent regarding the design or manufacture of the part. ON Semiconductor is an Equal Opportunity/Affirmative Action Employer. This literature is subject to all applicable copyright laws and is not for resale in any manner.

PUBLICATION ORDERING INFORMATION

LITERATURE FULFILLMENT:

Literature Distribution Center for ON Semiconductor
19521 E. 32nd Pkwy, Aurora, Colorado 80011 USA
Phone: 303-675-2175 or 800-344-3860 Toll Free USA/Canada
Fax: 303-675-2176 or 800-344-3867 Toll Free USA/Canada
Email: orderlit@onsemi.com

N. American Technical Support: 800-282-9855 Toll Free
USA/Canada
Europe, Middle East and Africa Technical Support:
Phone: 421 33 790 2910

ON Semiconductor Website: www.onsemi.com

Order Literature: <http://www.onsemi.com/orderlit>

For additional information, please contact your local
Sales Representative