

# LV5680P



ON Semiconductor®

## Multi Voltage Regulator IC Application Note

### Overview

The LV5680P is a multiple voltage regulator for car audio system. This IC has 4 voltage regulators and 2 high-side switches.

The following protection circuits are integrated: over current limiter, overvoltage protection and Thermal Shut Down. This IC is most suitable Car Audio.

### Features

- 4 LDO regulators
  - For VDD: Vout is 5.0V, I<sub>max</sub> is 200mA
  - For CD: Vout is 8.0V, I<sub>max</sub> is 1300mA
  - For Illumination: Vout is 8V to 12V(Adjustable external resistors), I<sub>max</sub> is 300mA
  - For Audio: Vout is 8V to 9V(Adjustable external resistors), I<sub>max</sub> is 300mA
- 2 High-side Switches
  - EXT : Voltage difference between input and output is 0.5V, I<sub>max</sub> is 350mA
  - ANT : Voltage difference between input and output is 0.5V, I<sub>max</sub> is 300mA
- 2 Switches connected to "VDD"
  - SW5V : Voltage difference between "VDD" and output is 0.2V, I<sub>max</sub> is 200mA
  - ACC(Accessory Voltage Detector output) : Voltage difference between "VDD" and output is 0.2V, I<sub>max</sub> is 100mA
- Over Current Limiting
- Overvoltage Protection (Without VDD-OUT) \*Detection voltage is 21V(typical)
- Thermal Shut Down \*175°C(typical)
- ACC voltage detector
- Maximum surge peak Voltage is 50V
- Low thermal resistance package "HZIP15J" ( $\theta_{jc}=2^{\circ}\text{C/W}$ )

(Warning) The protector functions only improve the IC's tolerance and they do not guarantee the safety of the IC if used under the conditions out of safety range or ratings. Use of the IC such as use under overcurrent protection range or thermal shutdown state may degrade the IC's reliability and eventually damage the IC.

# LV5680P Application Note

## Package Dimensions

unit : mm(typical)

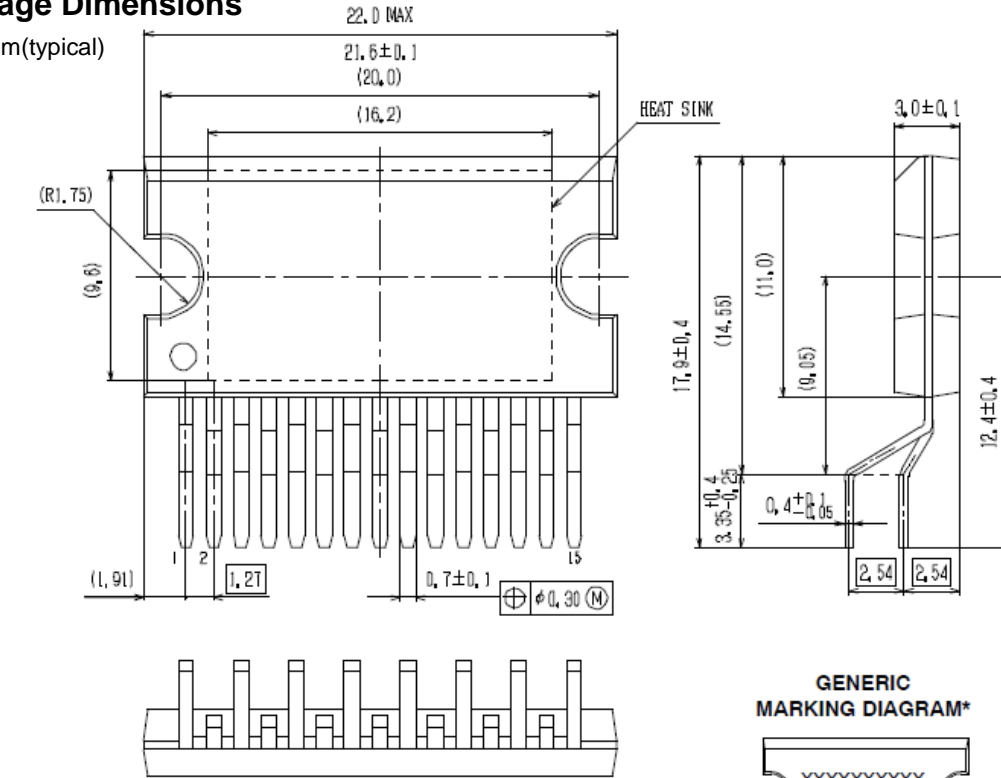

### GENERIC MARKING DIAGRAM\*

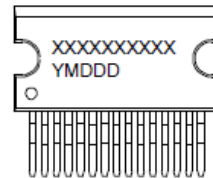

XXXXX = Specific Device Code  
Y = Year  
M = Month  
DDD = Additional Traceability Data

\*This information is generic. Please refer to device data sheet for actual part marking. Pb-Free indicator, "G" or microdot "•", may or may not be present.

### SOLDERING FOOTPRINT\*

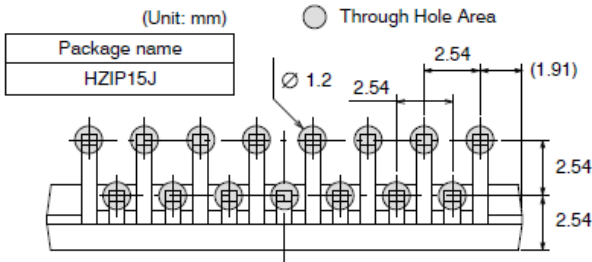

NOTE: The measurements are not to guarantee but for reference only.

\*For additional information on our Pb-Free strategy and soldering details, please download the ON Semiconductor Soldering and Mounting Techniques Reference Manual, SOLDERRM/D.

Fig1. Package Dimensions of HZIP15J

- Allowable power dissipation derating curve

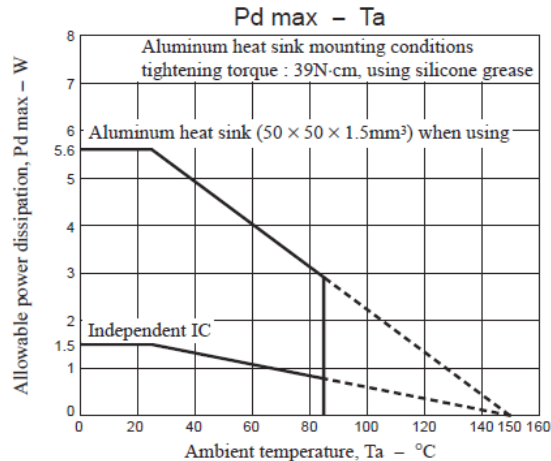

Fig2. Allowable Power Dissipation Derating Curve

# LV5680P Application Note

## Pin Assignment

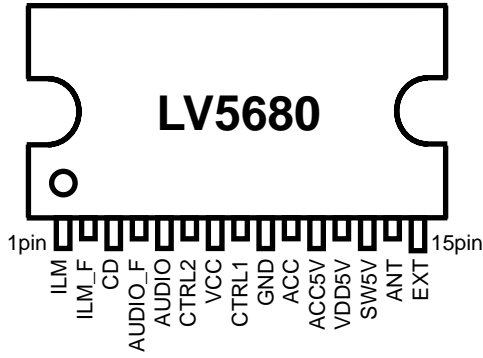

Fig3. Pin Assignment

## Block Diagram

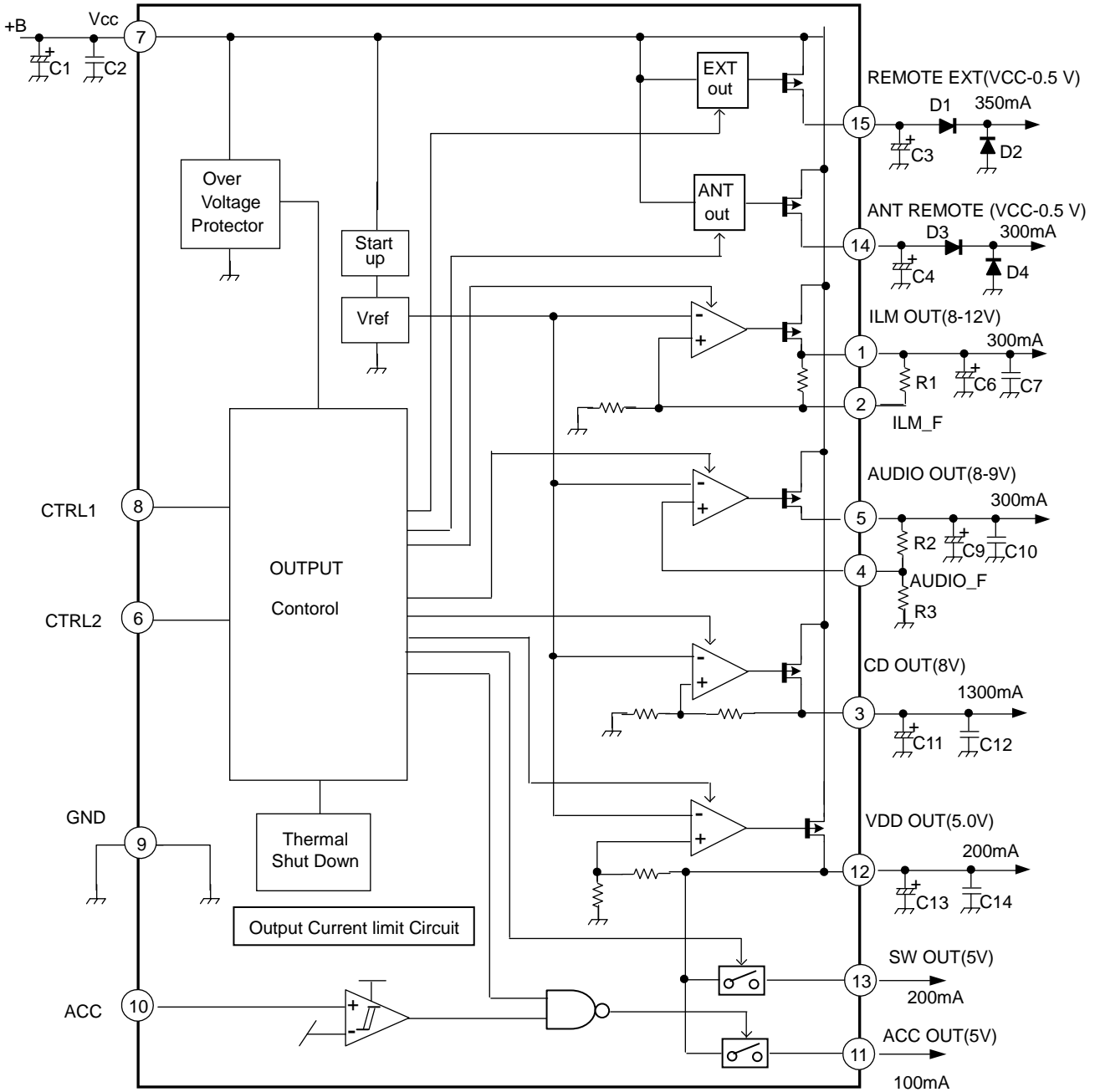

Fig4. Block Diagram of LV5680P

## LV5680P Application Note

### Specifications

#### Absolute Maximum Ratings at Ta=25 °C

Parameter	Symbol	Conditions	Ratings	Unit
Power supply voltage	Vcc max		36	V
Power dissipation	Pd max	Without heat sink	1.5	W
		At using Al heat sink(*1)	5.6	
		At heat sink of infinite area	32.5	
Peak voltage	Vcc peak	Regarding Bias wave, refer to below the pulse.	50	V
Operating temperature	Topr		-40 to +85	°C
Storage temperature	Tstg		-55 to +150	°C
Junction temperature	Tjmax		150	°C

\*1 : When the Aluminum heat sink(50mm×50mm×1.5mm) is used

• Peak Voltage testing pulse wave

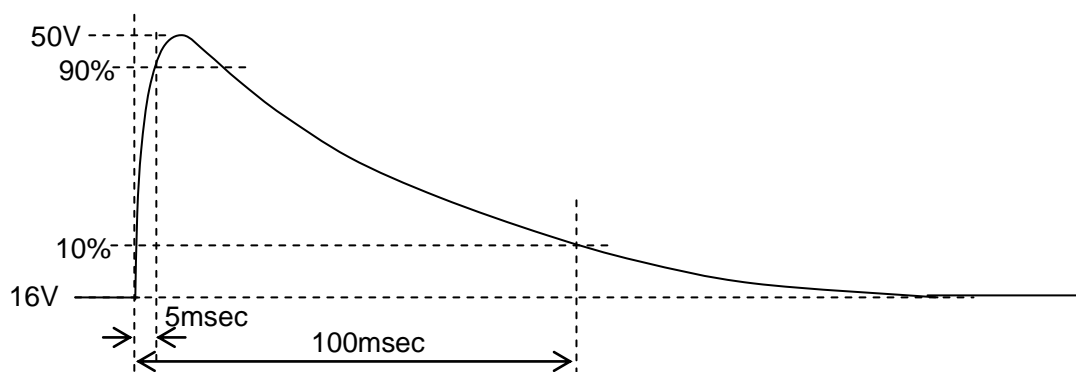

Fig5. Peak Voltage testing pulse wave

#### Allowable Operating Range at Ta=25 °C

Parameter	Conditions	Range	Unit
Power supply voltage range1	VDD output, SW output, ACC output	7.5 to 16	V
Power supply voltage range2	ILM output at 10V	12 to 16	V
	ILM output at 8V	10 to 16	V
Power supply voltage range3	AUDIO output at 9V	10 to 16	V
Power supply voltage range4	CD output(CD output current =1.3A)	10.5 to 16	V
	CD output(CD output current ≤1A)	10 to 16	V

## LV5680P Application Note

**Electrical Characteristics** at Ta=25 °C, Vcc=14.4V (\*2)

Parameter	Symbol	Conditions	Min	Typ	Max	Unit
Quiescent Current	I <sub>CC</sub>	VDD No Load, CTRL1/2=「L/L」, ACC=0V		400	800	μA
<b>CTRL1 Input</b>						
“L” Input voltage	V <sub>IL1</sub>		0		0.5	V
“M1” Input voltage	V <sub>IM1</sub>		0.8	1.1	1.4	V
“M2” Input voltage	V <sub>IM2</sub>		1.9	2.2	2.5	V
“H” Input voltage	V <sub>IH1</sub>		2.9	3.3	5.5	V
Input impedance	R <sub>IN1</sub>		350	500	650	kΩ
<b>CTRL2 Input</b>						
“L” Input voltage	V <sub>IL2</sub>		0		0.5	V
“M” Input voltage	V <sub>IM2</sub>		1.1	1.65	2.1	V
“H” Input voltage	V <sub>IH2</sub>		2.5	3.3	5.5	V
Input impedance	R <sub>IN2</sub>		350	500	650	kΩ
<b>VDD5V output (*3)</b>			<b>VDD5V supplies a current to SW5V and ACC5V</b>			
Output voltage1	V <sub>O1</sub>	I <sub>O1</sub> = 200 mA, I <sub>O7</sub> , I <sub>O8</sub> =0A	4.75	5.0	5.25	V
Output voltage2	V <sub>O1'</sub>	I <sub>O1</sub> =200mA, I <sub>O7</sub> =200mA, I <sub>O8</sub> =100mA	4.75	5.0	5.25	V
Output total current	I <sub>TO1</sub>	V <sub>O1</sub> ≥ 4.75V, I <sub>TO1</sub> =I <sub>O1</sub> +I <sub>O7</sub> +I <sub>O8</sub>	500			mA
Line regulation	ΔV <sub>OLN1</sub>	7.5V < V <sub>CC</sub> < 16 V, I <sub>O1</sub> = 200 mA(*4)		30	90	mV
Load regulation	ΔV <sub>OLD1</sub>	1 mA < I <sub>O1</sub> < 200 mA(*4)		70	150	mV
Dropout voltage 1	V <sub>DRDP1</sub>	I <sub>O1</sub> = 200 mA(*4)		1.0	1.5	V
Dropout voltage 2	V <sub>DRDP1'</sub>	I <sub>O1</sub> = 100 mA(*4)		0.7	1.05	V
Dropout voltage 3	V <sub>DRDP1''</sub>	I <sub>O1</sub> +I <sub>O7</sub> +I <sub>O8</sub> = 500 mA		2.5	3.75	V
Ripple rejection	R <sub>REJ1</sub>	f=120Hz, I <sub>O1</sub> = 200 mA(*4)	40	50		dB
<b>CD-ON ; CTRL2=“H”</b>						
Output voltage	V <sub>O2</sub>	I <sub>O2</sub> = 1000 mA	7.6	8.0	8.4	V
Output current capacity	I <sub>O2</sub>	V <sub>O2</sub> ≥ 7.6V	1300			mA
Line regulation	ΔV <sub>OLN2</sub>	10.5V < V <sub>CC</sub> < 16V, I <sub>O2</sub> =1000mA		50	100	mV
Load regulation	ΔV <sub>OLD2</sub>	10 mA < I <sub>O2</sub> < 1000 mA		100	200	mV
Dropout voltage1	V <sub>DRDP2</sub>	I <sub>O2</sub> = 1000 mA		1.0	1.5	V
Dropout voltage2	V <sub>DRDP2'</sub>	I <sub>O2</sub> = 500 mA		0.5	0.75	V
Ripple rejection	R <sub>REJ2</sub>	f=120Hz, I <sub>O2</sub> = 1000 mA	40	50		dB
<b>AUDIO (8-9V) -ON ; CTRL2=“M”&amp;“H”</b>						
AUDIO_F voltage	V <sub>I3</sub>		1.222	1.260	1.298	V
AUDIO_F current	I <sub>IN3</sub>		-1		1	μA
AUDIO output voltage1	V <sub>O3</sub>	I <sub>O3</sub> = 200 mA, R <sub>2</sub> =30kΩ, R <sub>3</sub> =5.6kΩ (*5)	7.65	8.0	8.35	V
AUDIO output voltage2	V <sub>O3'</sub>	I <sub>O3</sub> = 200 mA, R <sub>2</sub> =27kΩ, R <sub>3</sub> =4.7kΩ (*5)	8.13	8.5	8.87	V

## LV5680P Application Note

Parameter	Symbol	Conditions	Min	Typ	Max	Unit
<b>AUDIO (8-9V) -ON ; CTRL2="M"&amp;"H"</b>						
AUDIO output voltage3	Vo3' '	Io3= 200 mA, R2=24kΩ,R3=3.9kΩ(*5)	8.6	9.0	9.4	V
Output current capacity	Io3		300			mA
Line regulation	$\Delta V_{oLN3}$	10V<Vcc<16 V, Io3= 200 mA		30	90	mV
Load regulation	$\Delta V_{oLD3}$	1 mA<Io3<200 mA		70	150	mV
Dropout voltage1	V <sub>DROP3</sub>	Io3= 200 mA		0.3	0.45	V
Dropout voltage2	V <sub>DROP3'</sub>	Io3= 100 mA		0.15	0.23	V
Ripple rejection	R <sub>REJ3</sub>	f=120Hz, Io3= 200 mA	40	50		dB
<b>ILM (8-12V) -ON ; CTRL1="M1", "M2"&amp;"H"</b>						
ILM_F voltage	V <sub>I4</sub>		1.222	1.260	1.298	V
ILM output voltage1	Vo4	Io4= 200 mA	11.4	12.0	12.6	V
ILM output voltage2	Vo4'	Io4= 200 mA, R1=270kΩ(*6)	8.5	10.0	11.5	V
ILM output voltage3	Vo4' '	Io4= 200 mA, R1=100kΩ(*6)	6.8	8.0	9.2	V
Output current capacity	Io4	R1 =270kΩ	300			mA
Line regulation	$\Delta V_{oLN4}$	12V<Vcc<16V, Io4=200mA,R1=270kΩ		30	90	mV
Load regulation	$\Delta V_{oLD4}$	1 mA<Vo4<200,mA		70	150	mV
Dropout voltage1	V <sub>DROP4</sub>	Io4= 200 mA		0.7	1.05	V
Dropout voltage2	V <sub>DROP4'</sub>	Io4= 100 mA		0.35	0.53	V
Ripple rejection	R <sub>REJ4</sub>	f=120Hz ,Io4= 200 mA	40	50		dB
<b>REMOTE(EXT)-ON ; CTRL1="M2"&amp;"H"</b>						
Output voltage	Vo5	Io5= 350 mA	Vcc-1.0	Vcc-0.5		V
Output current capacity	Io5	Vo5 ≥ Vcc-1.0	350			mA
<b>ANT Remote-ON ; CTRL1="H"</b>						
Output voltage	Vo6	Io6= 300 mA	Vcc-1.0	Vcc-0.5		V
Output current capacity	Io6	Vo6 ≥ Vcc-1.0	300			mA
<b>SW5V output ; CTRL2="M"&amp;"H"</b>						
Output voltage1	Vo7	Io7= 1 mA, Io1,Io8= 0A(*7)	Vo1-0.25	Vo1		V
Output voltage2	Vo7'	Io7= 200 mA, Io1,Io8= 0A(*7)	Vo1-0.45	Vo1-0.2		V
Output current capacity	Io7	Vo7 ≥ 4.55	200			mA
<b>ACC Detector ; Vout=5V coupled ACC</b>						
ACC detection voltage	V <sub>TH8</sub>		2.8	3.0	3.2	V
Hysteresis	V <sub>HIS8</sub>		0.2	0.3	0.4	V
Input impedance	Z <sub>I8</sub>	Included Pull-down resistor	42	60	78	kΩ
ACC Vout1	Vo8	Io8= 0.5 mA, Io1,Io7= 0A(*7)	Vo1-0.25	Vo1		V
ACC Vout2	Vo8'	Io8= 100 mA, Io1,Io7= 0A(*7)	Vo1-0.45	Vo1-0.2		V
Output current capacity	Io8	Vo8 ≥ 4.55	100			mA

## LV5680P Application Note

\*2 : The entire specification has been defined based on the tests performed under the conditions where  $T_j$  and  $T_a(=25^{\circ}\text{C})$  are almost equal. These tests were performed with pulse load to minimize the increase of junction temperature ( $T_j$ ).

\*3 : The VDD5V output supplies the output currents of SW5V and ACC5V. Therefore, the current supply capability of the VDD5V output and its other electrical characteristics are affected by the output statuses of SW5V and ACC5V.

\*4 : SW5V and ACC5V outputs have no load.

\*5 : When a resistor tolerance  $\pm 1\%$  is used.

**<Reference>** When a resistor tolerance  $\pm 0.5\%$  is used,  $V_{o3}$  ' is  $8.67\text{V} \leq 9.0\text{V} \leq 9.33\text{V}$ .

\*6 : When a resistor tolerance  $\pm 1\%$  is used. The absolute accuracy of the internal resistance is  $\pm 15\%$ .

\*7 : Since the "SW5V" and "ACC5V" are output from "VDD5V" through the switch, each output voltage drops by an amount equivalent to the ON resistance of the switch.

## LV5680P Application Note

### True Table of CTRL

CTRL1	ANT	EXT	ILM
L	OFF	OFF	OFF
M1	OFF	OFF	ON
M2	OFF	ON	ON
H	ON	ON	ON

CTRL2	CD	AUDIO	SW5
L	OFF	OFF	OFF
M	OFF	ON	ON
H	ON	ON	ON

### Timing Chart

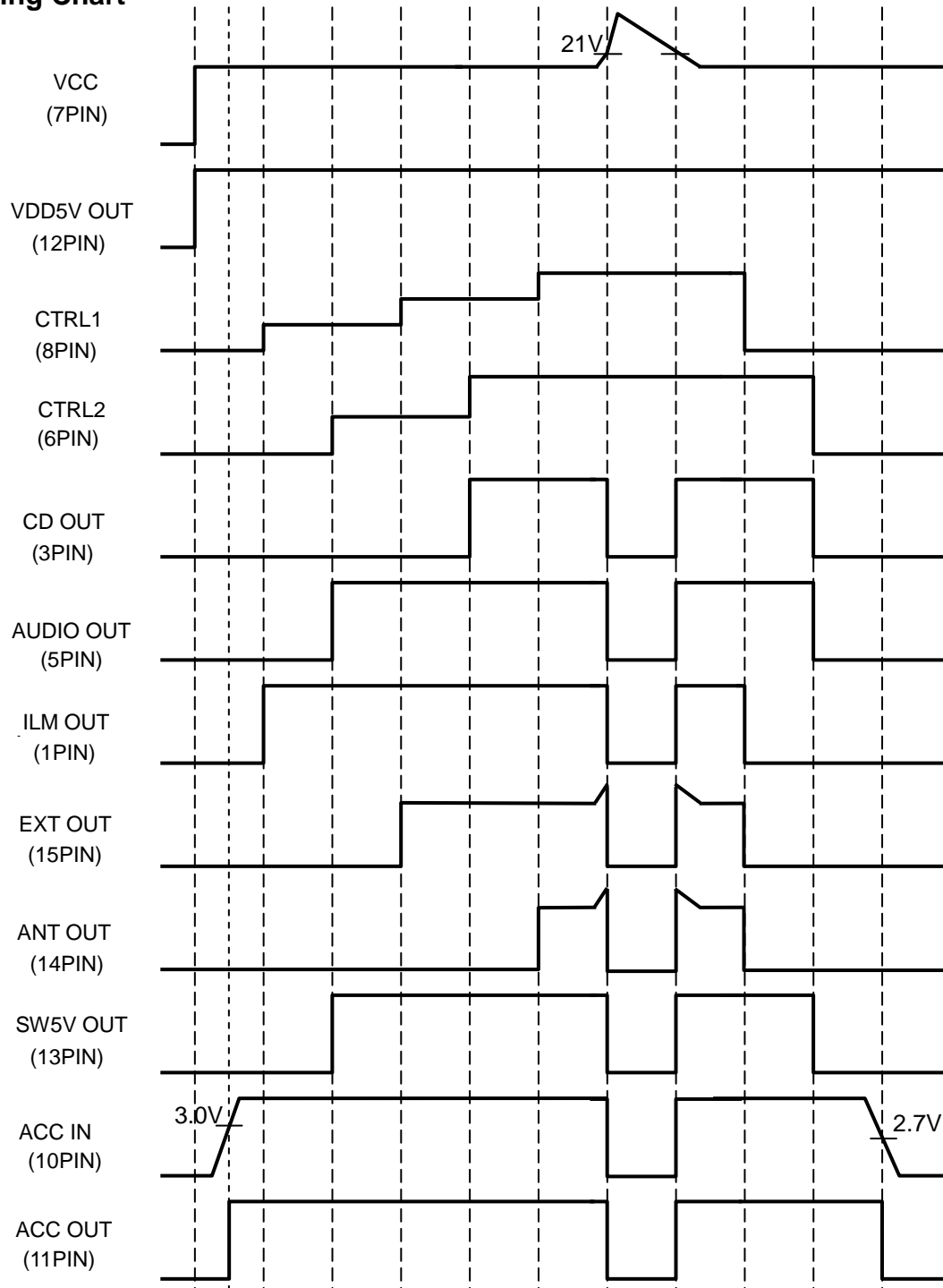

Fig6. Timing Chart



# LV5680P Application Note

## Main Characteristics

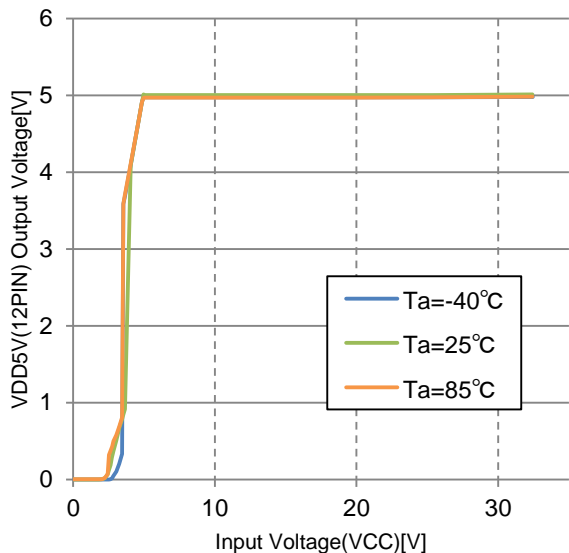

Fig7. [VDD] Vo vs. Input Voltage

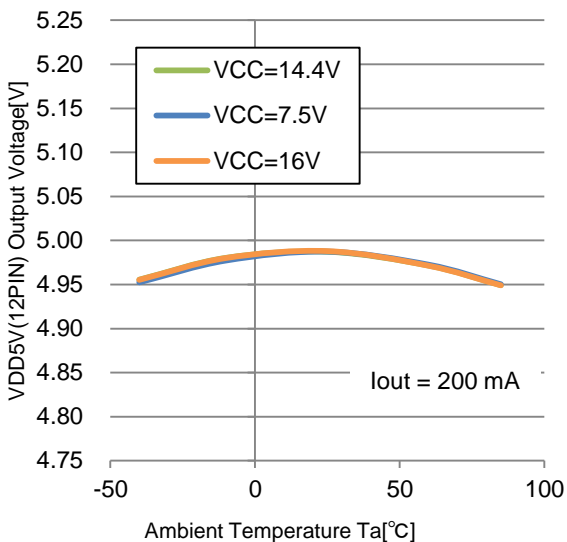

Fig8. [VDD] Vo vs. Ta

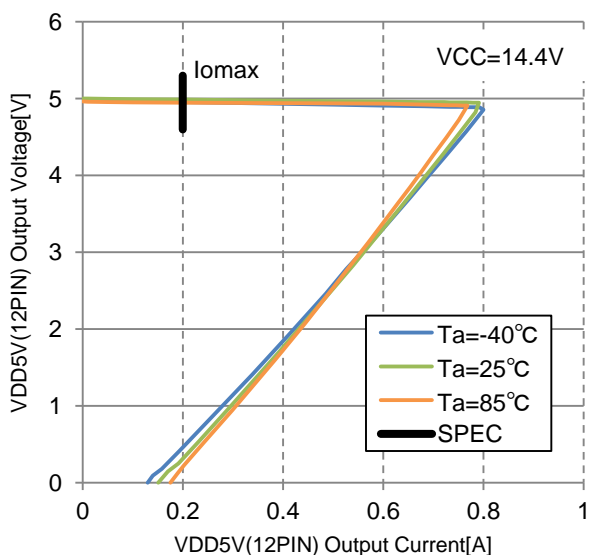

Fig9. [VDD] Vo vs. Io@VCC=14.4V

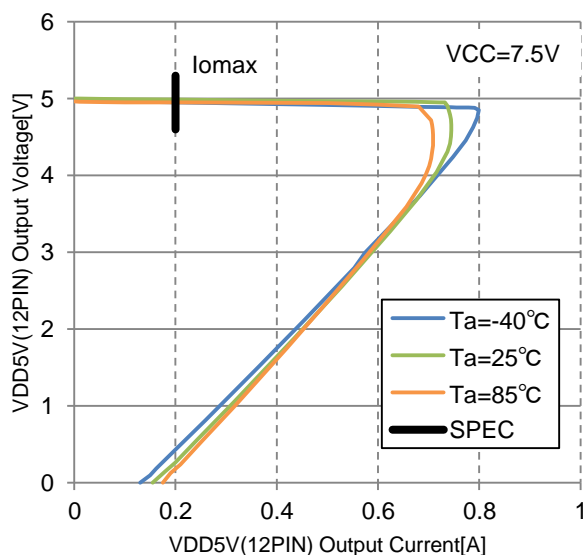

Fig10. [VDD] Vo vs. Io@VCC=7.5V

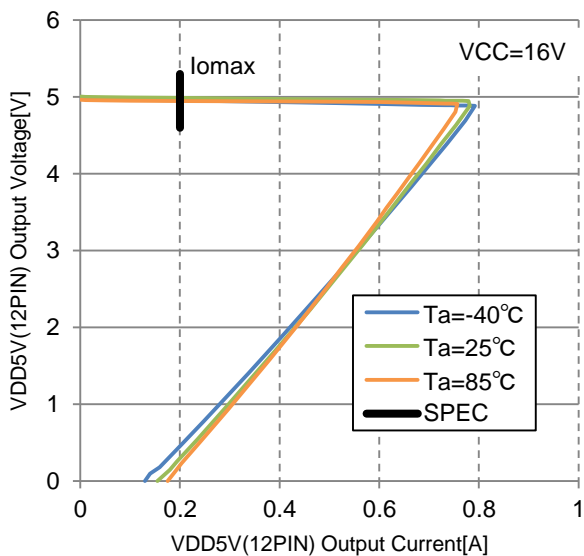

Fig11. [VDD] Vo vs. Io@VCC=16V

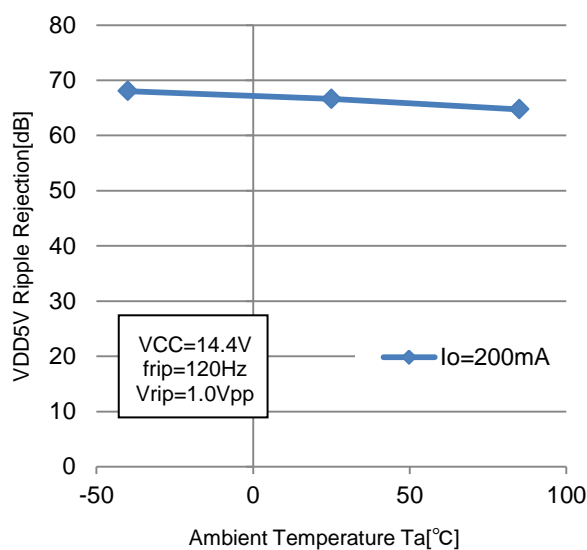

Fig12. [VDD] Ripple Rejection vs. Ta

# LV5680P Application Note

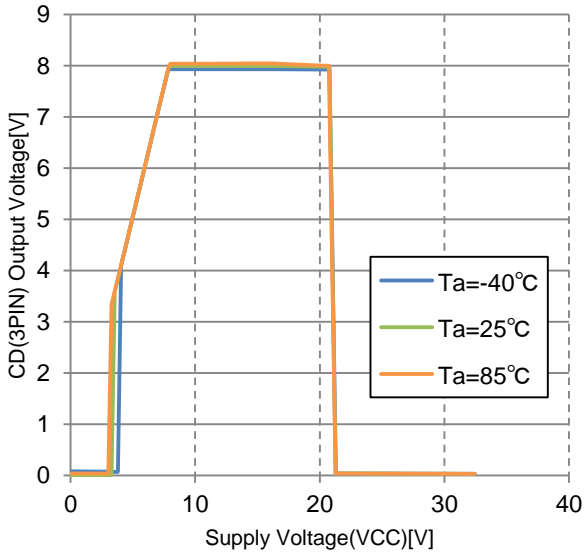

Fig13. [CD] Vo vs. Input Voltage

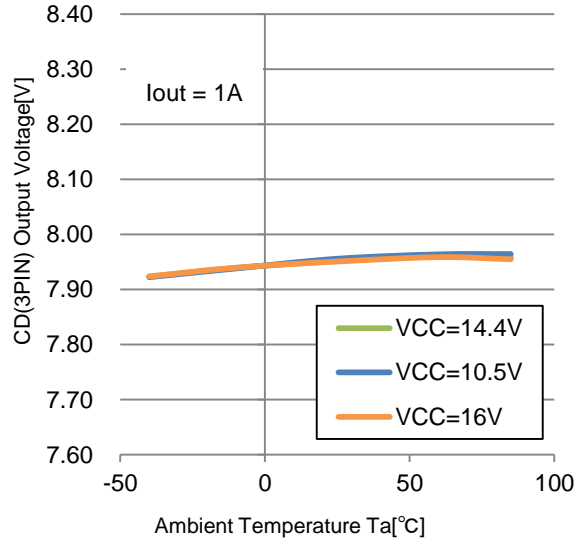

Fig14. [CD] Vo vs. Ta

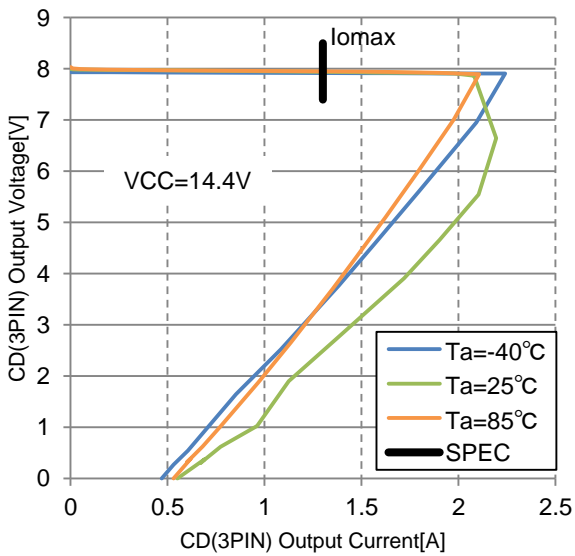

Fig15. [CD] Vo vs. Io @ VCC=14.4V

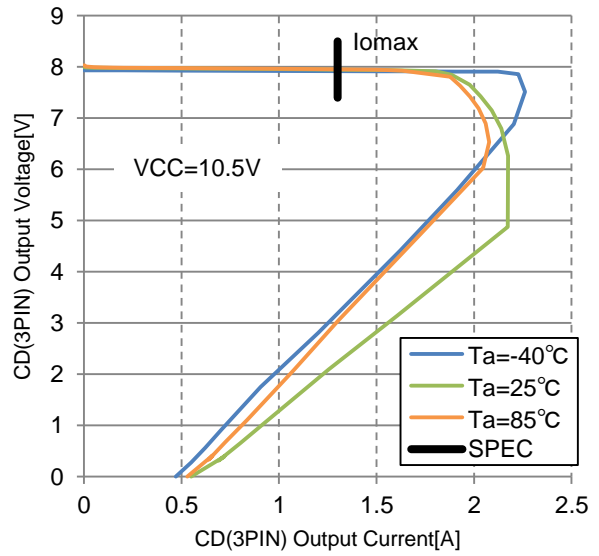

Fig16. [CD] Vo vs. Io @ VCC=10.5V

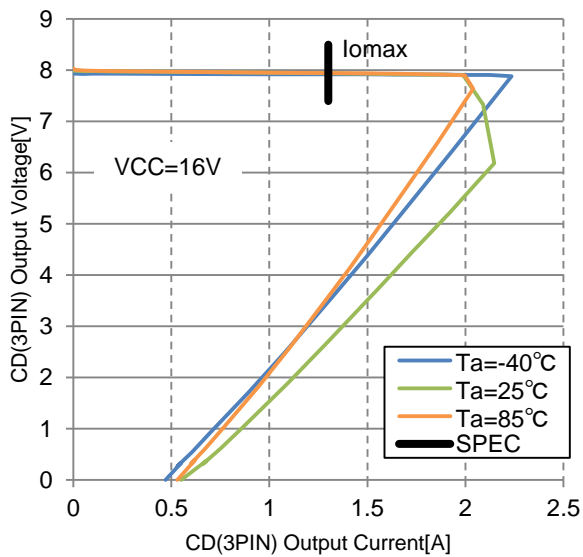

Fig17. [CD] Vo vs. Io @ VCC=16V

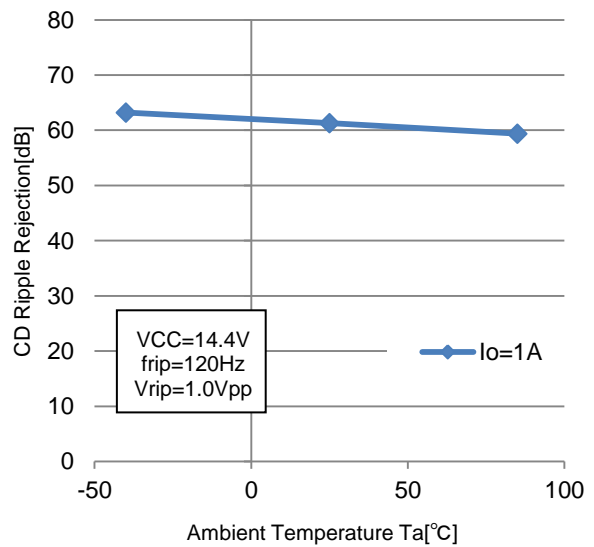

Fig18. [CD] Ripple Rejection vs. Ta

# LV5680P Application Note

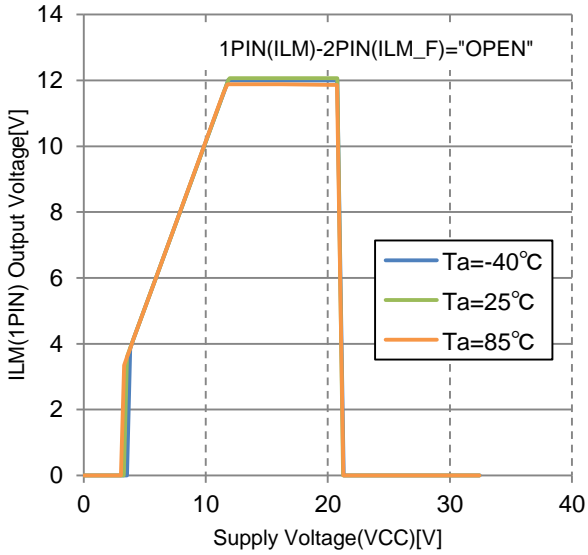

Fig19. [ILM(12V)] Vo vs. Input Voltage

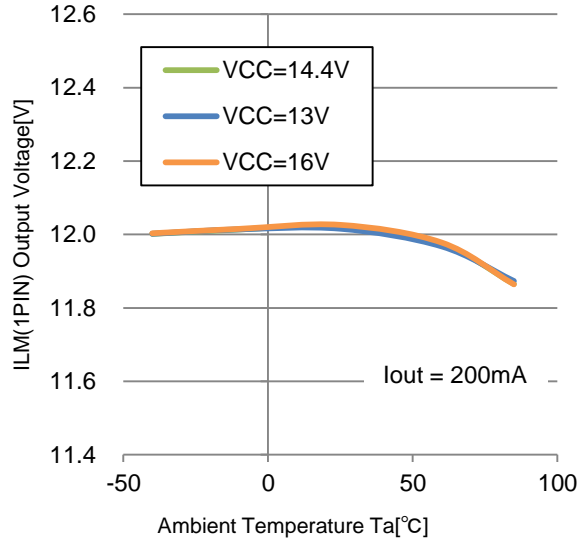

Fig20. [ILM(12V)] Vo vs. Ta

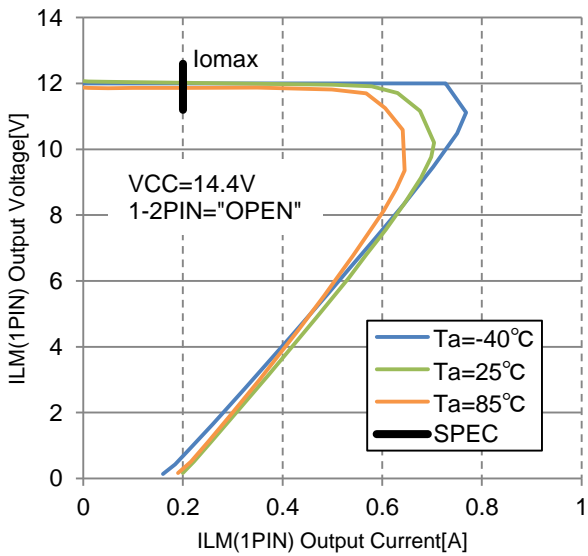

Fig21. [ILM(12V)] Vo vs. Io@VCC=14.4V

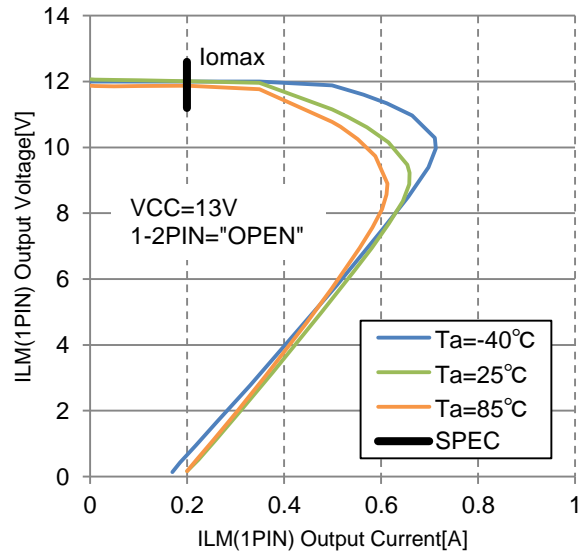

Fig22. [ILM(12V)] Vo vs. Io@VCC=13V

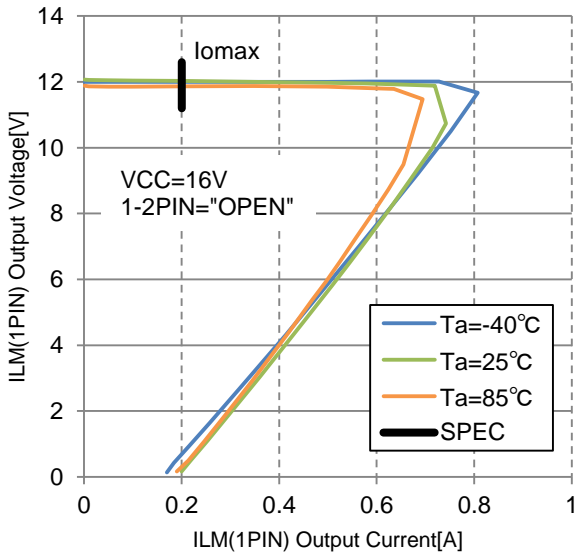

Fig23. [ILM(12V)] Vo vs. Io@VCC=16V

# LV5680P Application Note

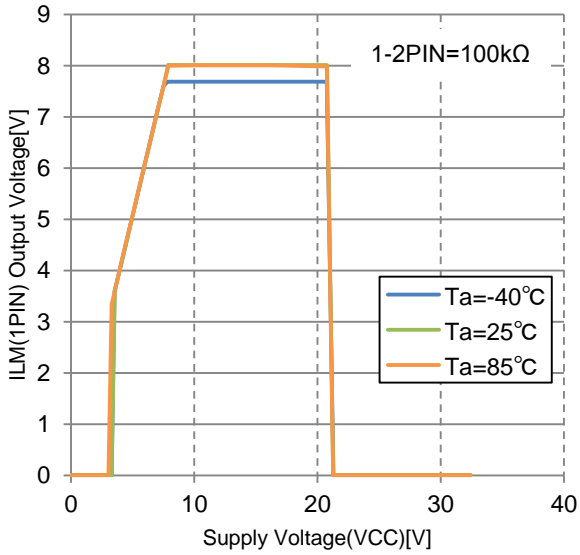

Fig24. [ILM(8V)] Vo vs. Input Voltage

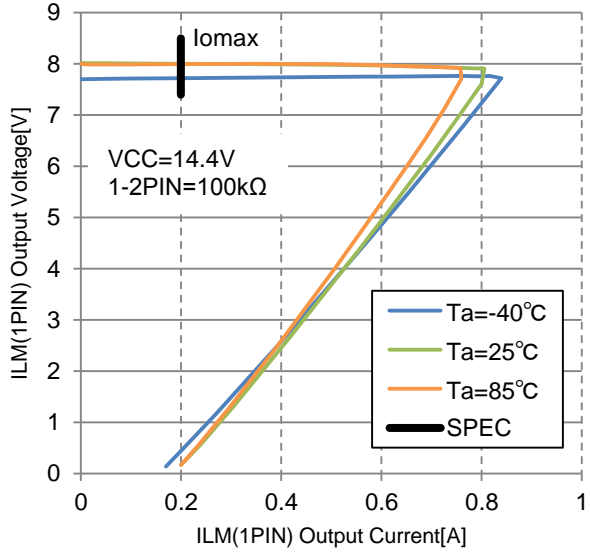

Fig25. [ILM(8V)] Vo vs. Io@VCC=14.4V

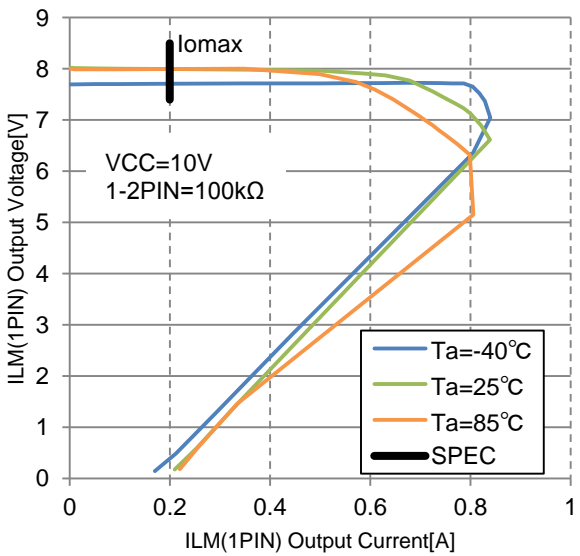

Fig26. [ILM(8V)] Vo vs. Io@VCC=10V

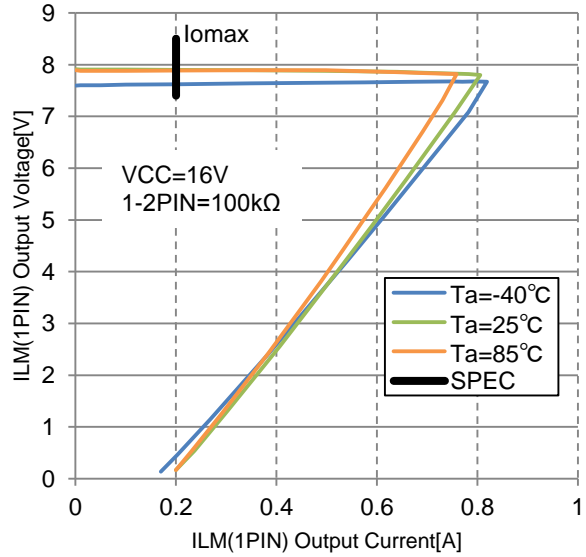

Fig27. [ILM(8V)] Vo vs. Io@VCC=16V

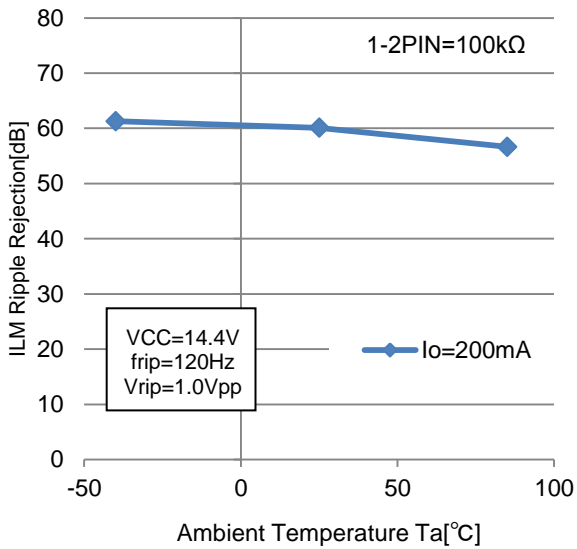

Fig28. [ILM(8V)] Ripple Rejection vs. Ta

# LV5680P Application Note

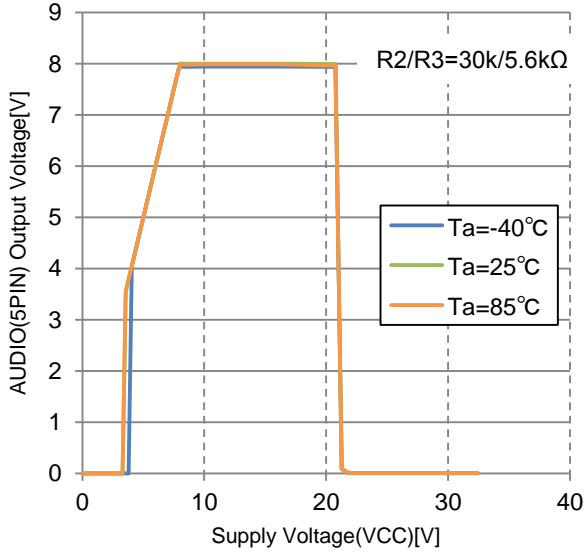

Fig29. [AUDIO(8V)] Vo vs. Input Voltage

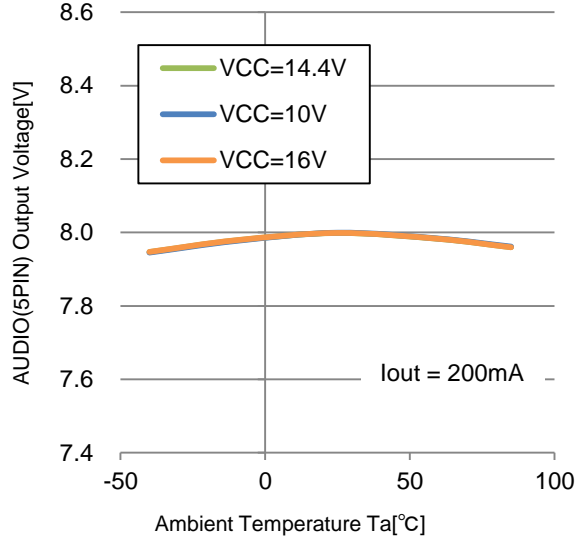

Fig30. [AUDIO(8V)] Vo vs. Ta

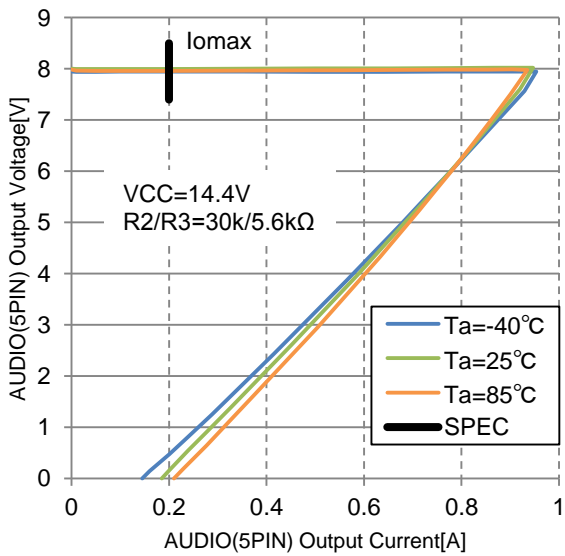

Fig31. [AUDIO(8V)] Vo vs. Io @ VCC=14.4V

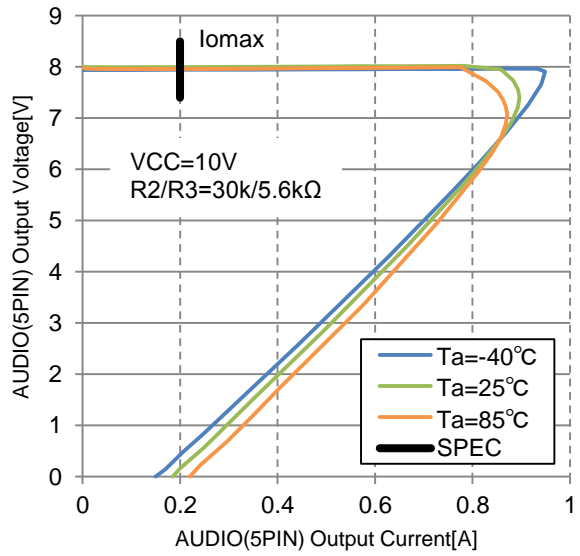

Fig32. [AUDIO(8V)] Vo vs. Io @ VCC=10V

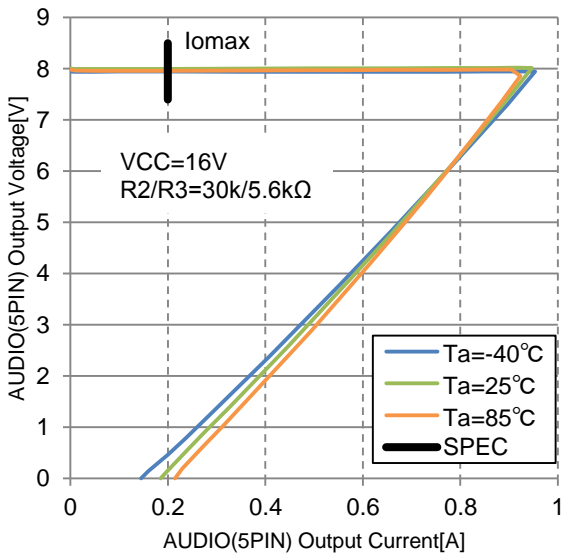

Fig33. [AUDIO(8V)] Vo vs. Io @ VCC=16V

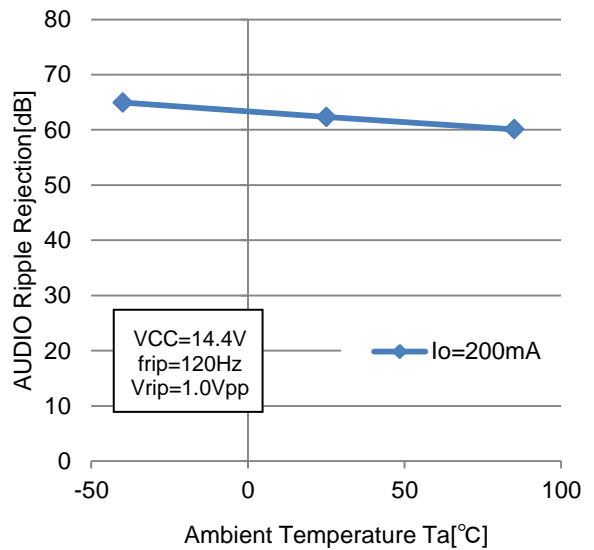

Fig34. [AUDIO(8V)] Ripple Rejection vs. Ta

# LV5680P Application Note

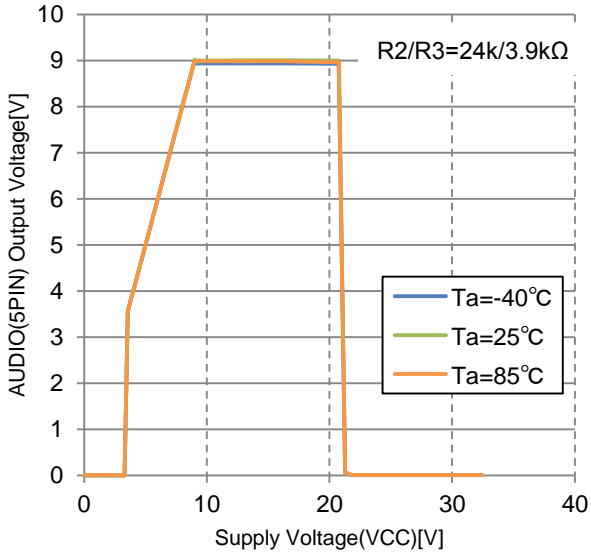

Fig35. [AUDIO(9V)] Vo vs. Input Voltage

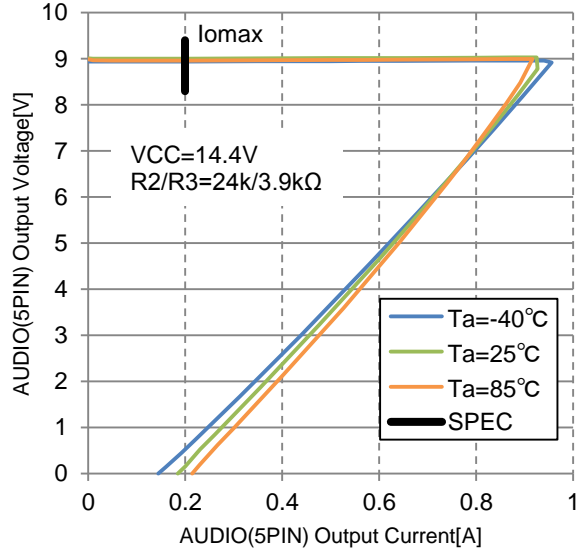

Fig36. [AUDIO(9V)] Vo vs. Io@VCC=14.4V

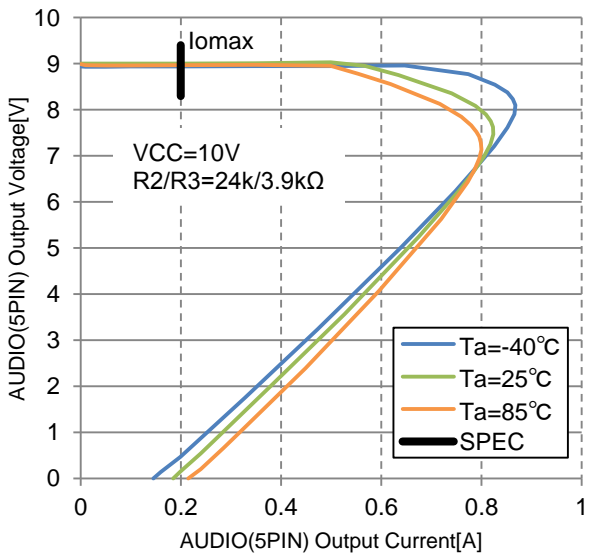

Fig37. [AUDIO(9V)] Vo vs. Io@VCC=10V

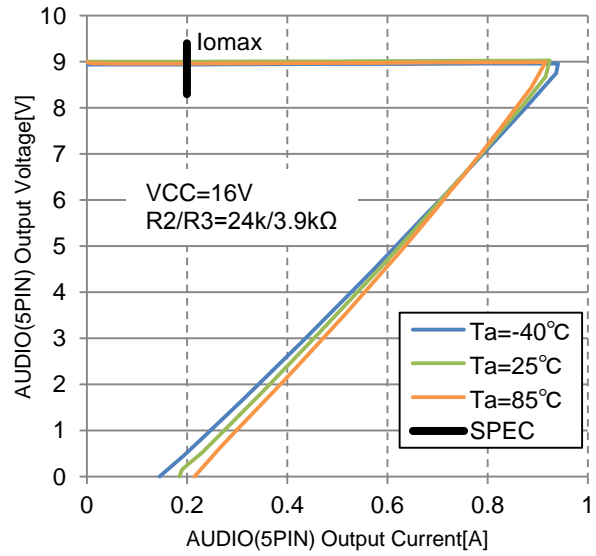

Fig38. [AUDIO(9V)] Vo vs. Io@VCC=16V

# LV5680P Application Note

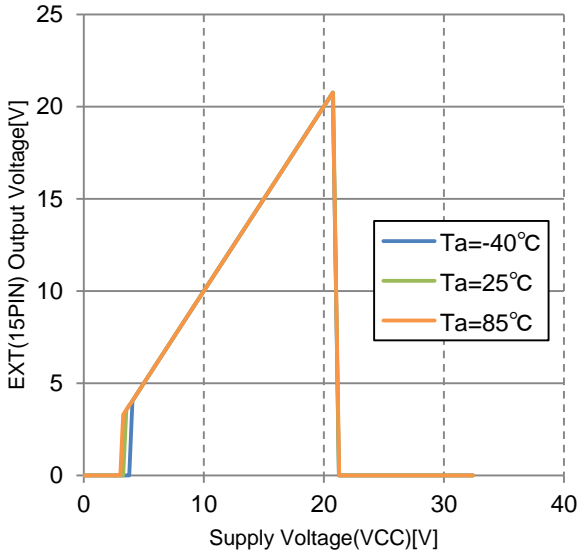

Fig39. [EXT] Vo vs. Input Voltage

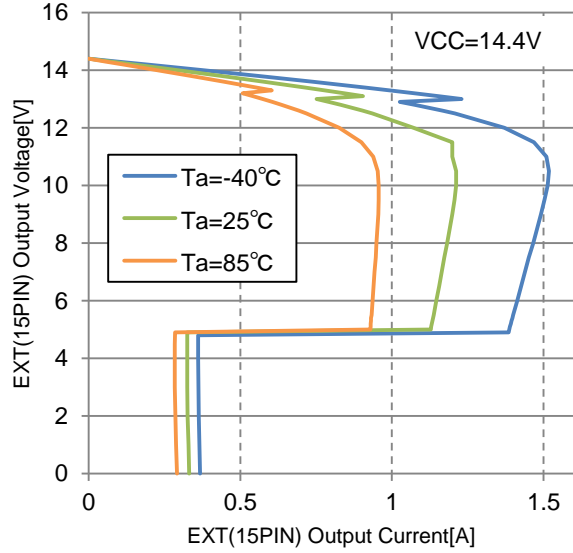

Fig40. [EXT] Vo vs. Io@VCC=14.4V

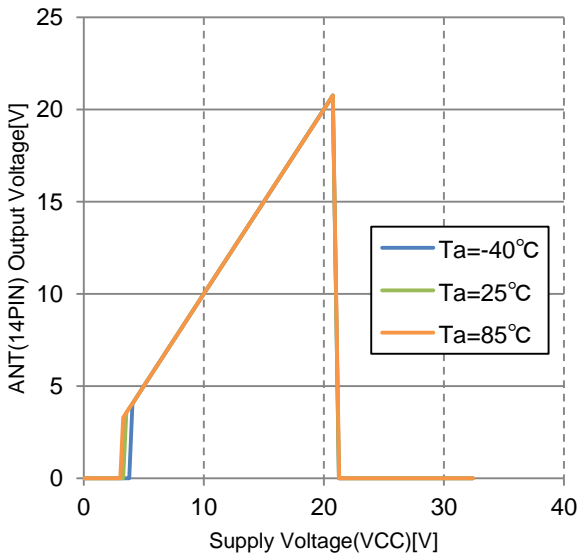

Fig41. [ANT] Vo vs. Input Voltage

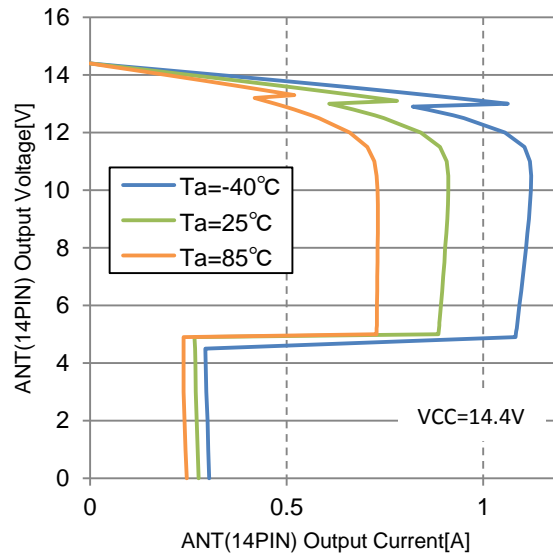

Fig42. [ANT] Vo vs. Io@VCC=14.4V

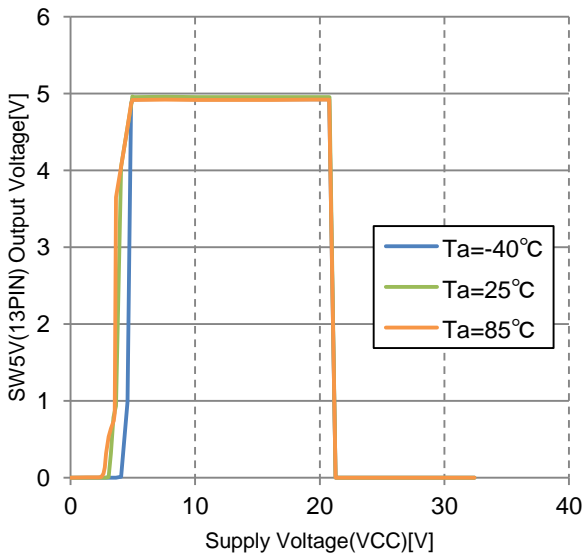

Fig43. [SW5V] Vo vs. Input Voltage

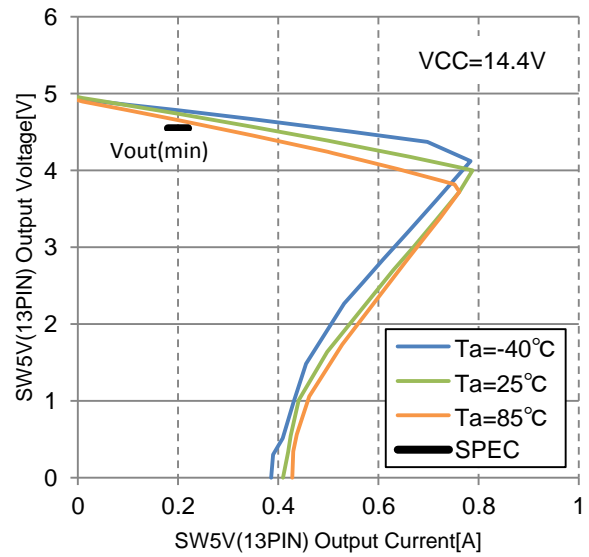

Fig44. [SW5V] Vo vs. Io@VCC=14.4V

# LV5680P Application Note

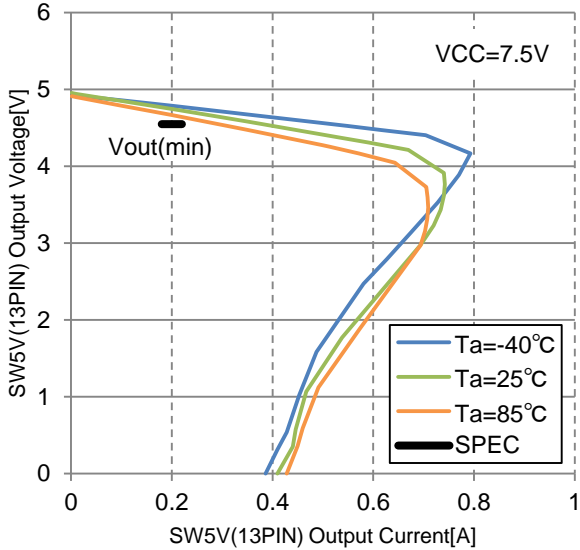

Fig45. [SW5V] Vo vs. Io@VCC=7.5V

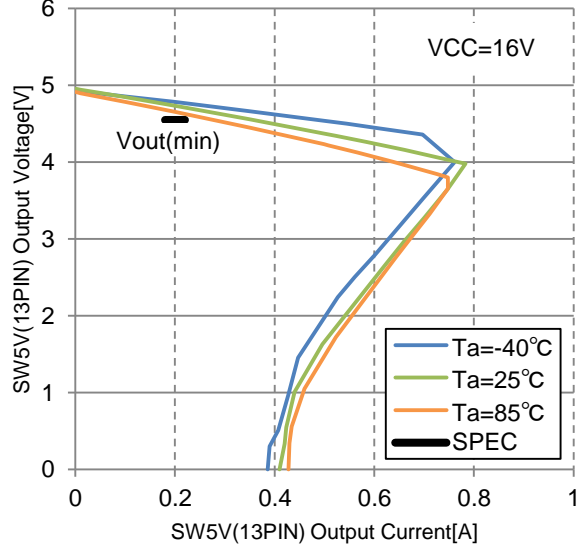

Fig46. [SW5V] Vo vs. Io@VCC=16V

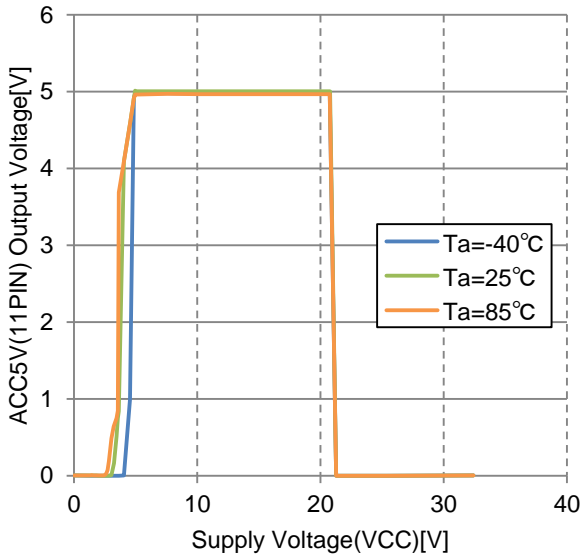

Fig47. [ACC5V] Vo vs. Input Voltage

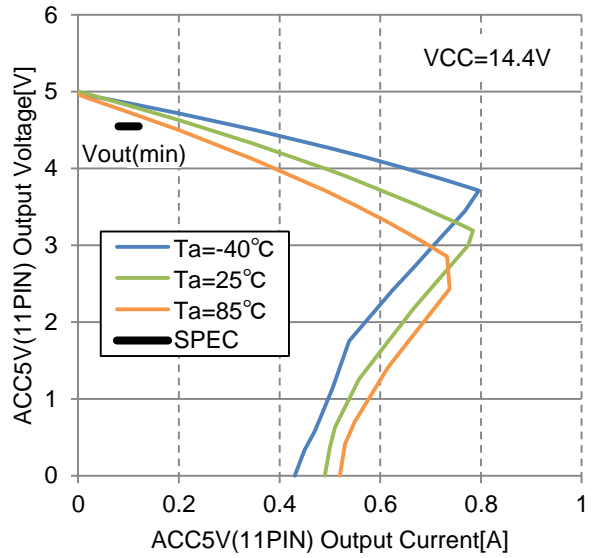

Fig48. [ACC5V] Vo vs. Io@VCC=14.4V

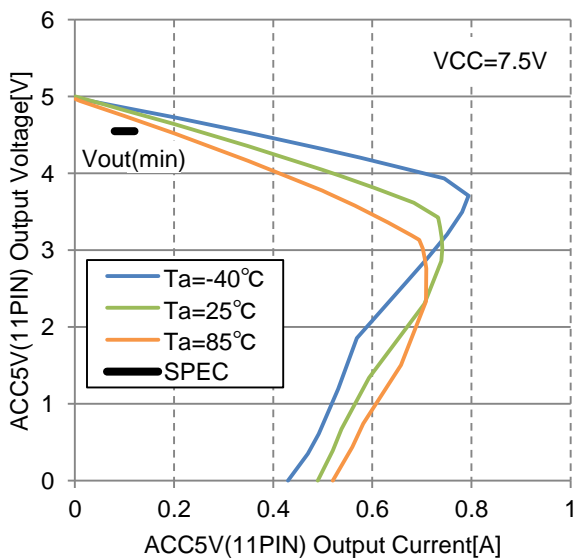

Fig49. [ACC5V] Vo vs. Io@VCC=7.5V

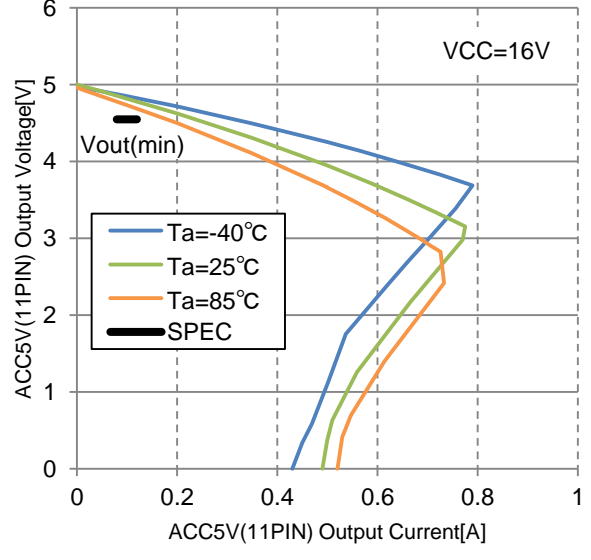

Fig50. [ACC5V] Vo vs. Io@VCC=16V



## LV5680P Application Note

### Terminal outline

Pin No.	Terminal	Function	Equivalent circuit
1	ILM	ILM OUT at CTRL1=M1,M2,H, OUT=ON 12.0V/300mA	
2	ILM_F	ILM Feed back	
3	CD	CD OUT at CTRL2=M,H, OUT=ON 8.0V/1.3A	
4	AUDIO_F	AUIDO Feed back	
5	AUDIO	AUDIO OUT at CTRL2=M,H, OUT=ON	
6	CTRL2	CTRL2(Input) 3 input values	

## LV5680P Application Note

Pin No.	Terminal	Function	Equivalent circuit
7	VCC	Power	
8	CTRL1	CTRL1(Input) 4 input values	
9	GND	GND	
10	ACC	Accessory Voltage detector(input)	
11	ACC5V	Accessory OUT At ACC > 3V, OUT=ON	
12	VDD5V	VDD5V OUT 5.0V/200mA	
13	SW5V	SW5V OUT at CTRL2=M,H, OUT=ON	
14	ANT	ANT OUT at CTRL1=H, OUT=ON VCC-0.5V/300mA	

## LV5680P Application Note

Pin No.	Terminal	Function	Equivalent circuit
15	EXT	EXT OUT at CTRL1=M2,H, OUT=ON VCC-0.5V/350mA	

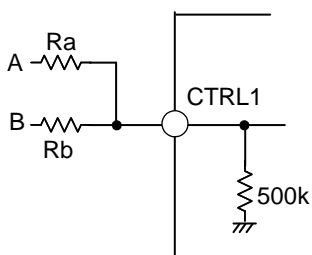

Fig51. CTRL1 Application Circuit

Input 3.3V : Ra=4.7kΩ, Rb=10kΩ

A	B	CTRL1
0V	0V	0V
0V	3.3V	1.05V
3.3V	0V	2.23V
3.3V	3.3V	3.20V

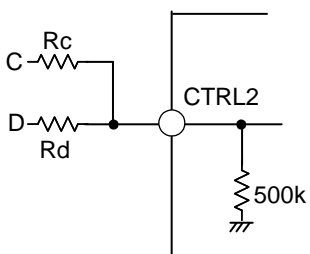

Fig52. CTRL2 Application Circuit

Input 3.3V : Rc=Rd=4.7kΩ

C	D	CTRL2
0V	0V	0V
0V	3.3V	1.61V
3.3V	0V	1.61V
3.3V	3.3V	3.29V

# LV5680P Application Note

## Board Layout

- Layer 1(Top)

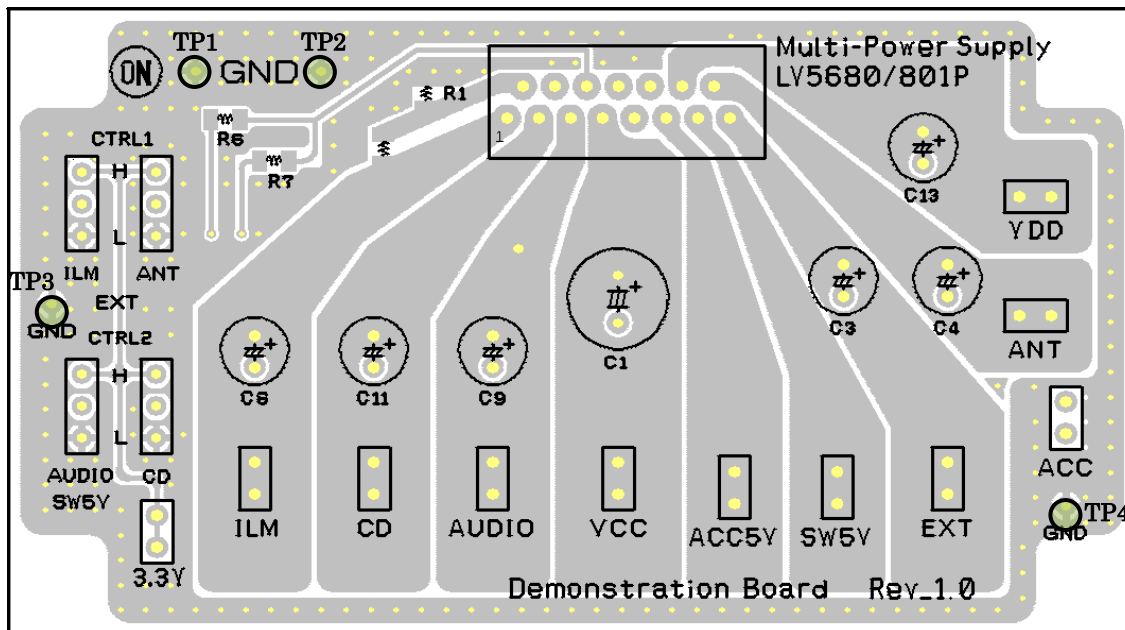

Fig53. Top Layer

- Layer 2(Bottom)

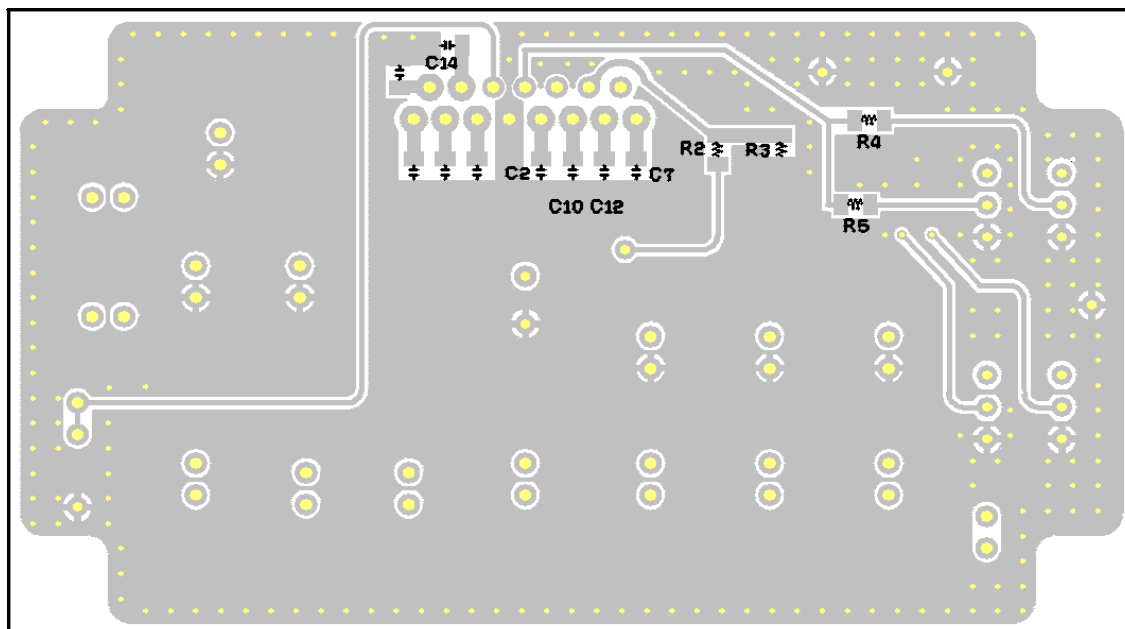

Fig54. Bottom Layer

# LV5680P Application Note

## Application Circuit Example

### LV5680P

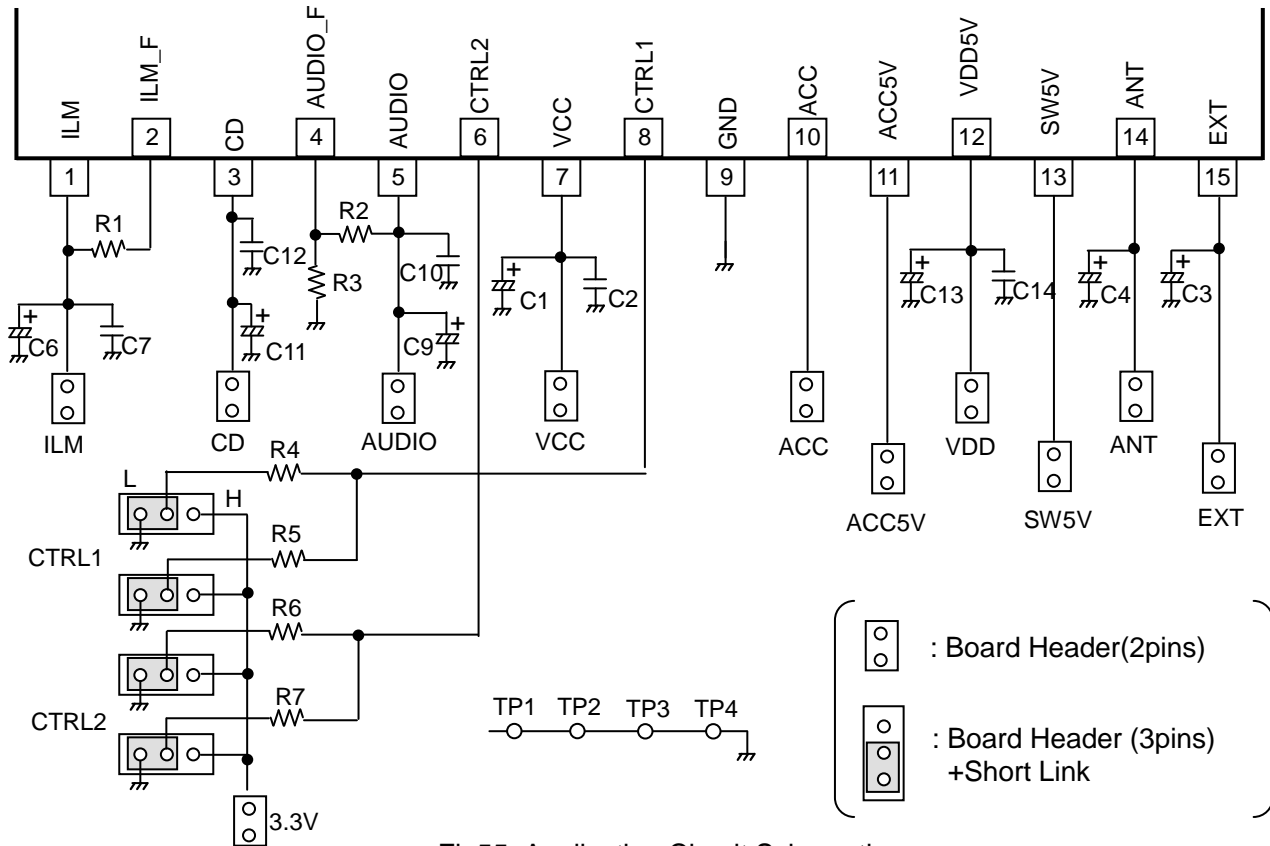

Fig55. Application Circuit Schematic

### Bill of Materials

Reference	Value	Part	Vendor	Comments
C1	100 $\mu$ F/50V	UVR1H101MPD	nichicon	Capacitor, Aluminum Electrolytic
C2,C7,C10, C12,C14	0.22 $\mu$ F/50V	GRM21BR71H224KA01L	Murata	Capacitor, Ceramic
C3,C4	2.2 $\mu$ F/50V	UVK1H2R2MDD	nichicon	Capacitor, Aluminum Electrolytic
C6,C9, C11,C13	10 $\mu$ F/25V	UMA1E100MDD/ ECEA1FKS100	nichicon/ Panasonic	Capacitor, Aluminum Electrolytic
R1	270k $\Omega$ /0.125W	CRG0805F270K	Tyco Electronics	Resistor, Thick Film
R2	27k $\Omega$ /0.125W	CRG0805F27K	Tyco Electronics	Resistor, Thick Film
R3,R5, R6,R7	4.7k $\Omega$ /0.125W	CRG0805F4K7	Tyco Electronics	Resistor, Thick Film
R4	10k $\Omega$ /0.125W	CRG0805F10K	Tyco Electronics	Resistor, Thick Film
BH(3pins)	3pins	W81136T3843RC	RS	Board Header
SL*		W8010T50RC	RS	Short Link
BH(2pins)	2pins	M20 9763646	RS	Board Header
TP1-TP4		ST-4-2	MAC8	Test Point

## LV5680P Application Note

### • Setting method of ILM Output Voltage

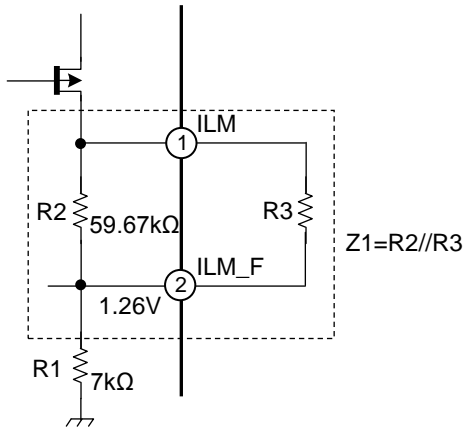

( ILM\_F is equal to bandgap reference voltage. (typ=1.26V) )

Fig56. ILM feed-back network

ILM calculating formula

$$Z_1 = R_2 // R_3 = \frac{R_2 \cdot R_3}{R_2 + R_3}$$

$$ILM = \frac{1.26[V]}{R_1} \times Z_1 + 1.26[V]$$

$$Z_1 = \frac{(ILM - 1.26) \cdot R_1}{1.26} \quad R_3 = \frac{R_2 \cdot Z_1}{R_2 - Z_1}$$

(Ex.) Setup to ILM=9V

$$Z_1 = \frac{(9V - 1.26V) \cdot 7k\Omega}{1.26V} \cong 43k\Omega$$

$$R_3 = \frac{59.67k\Omega \cdot 43k\Omega}{59.67k\Omega - 43k\Omega} \cong 153.9k\Omega \rightarrow 150k\Omega$$

When R3=150kΩ, ILM output voltage is

$$Z_1' = \frac{59.67k\Omega \cdot 150k\Omega}{59.67k\Omega + 150k\Omega} \cong 42.69k\Omega$$

$$ILM = \frac{1.26V}{7k\Omega} \times 42.69k\Omega + 1.26V \cong 8.94V$$

### • Setting method of AUDIO Output Voltage

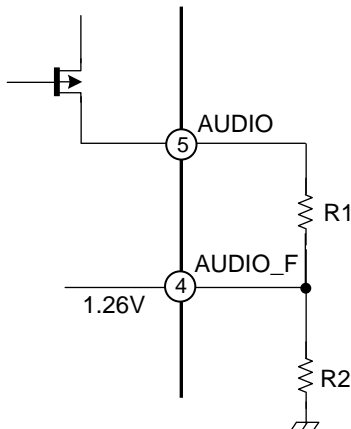

( AUDIO\_F is equal to bandgap reference voltage. (typ=1.26V) )

Fig57. AUDIO feed-back network

AUDIO calculating formula

$$AUDIO = \frac{1.26[V]}{R_2} \times R_1 + 1.26[V]$$

$$\frac{R_1}{R_2} = \frac{(AUDIO - 1.26)}{1.26}$$

Please design so that the ratio of R1 and R2 may fill the above-mentioned expression for the set AUDIO voltage.

(Ex.) Setup to AUDIO=8.5V

$$\frac{R_1}{R_2} = \frac{(8.5 - 1.26)}{1.26} \cong 5.75$$

$$\frac{R_1}{R_2} = \frac{27k\Omega}{4.7k\Omega} \cong 5.74$$

$$AUDIO = 1.26V \times 5.74 + 1.26V \cong 8.49V$$

\*The above-mentioned are all the values at the typical. The error margin of output voltage is caused by the influence of the manufacturing variations of IC and external resistance.

## LV5680P Application Note

### Reference data for selecting output capacitor

#### VDD5V & ILM STABLE REGION

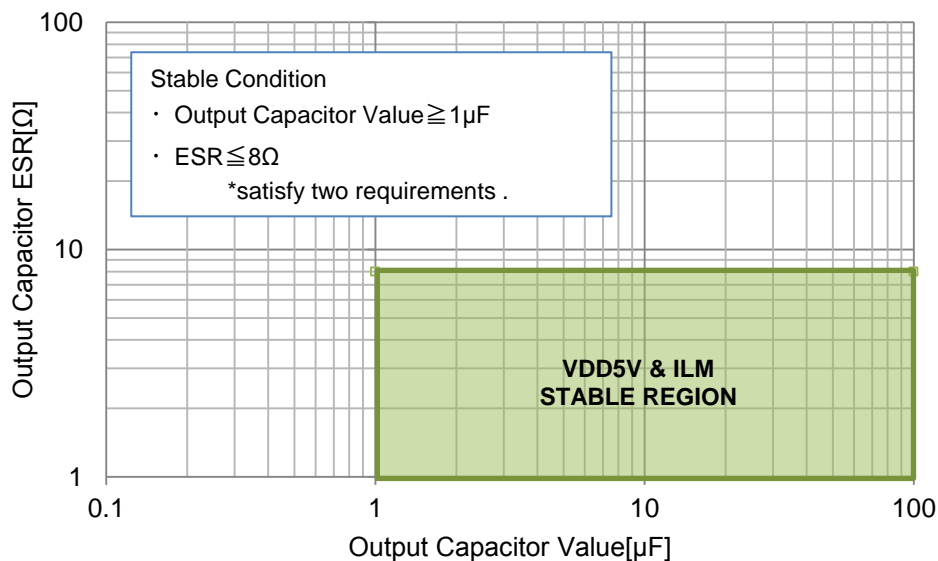

Fig58. VDD5V & ILM STABLE REGION

#### CD & AUDIO STABLE REGION

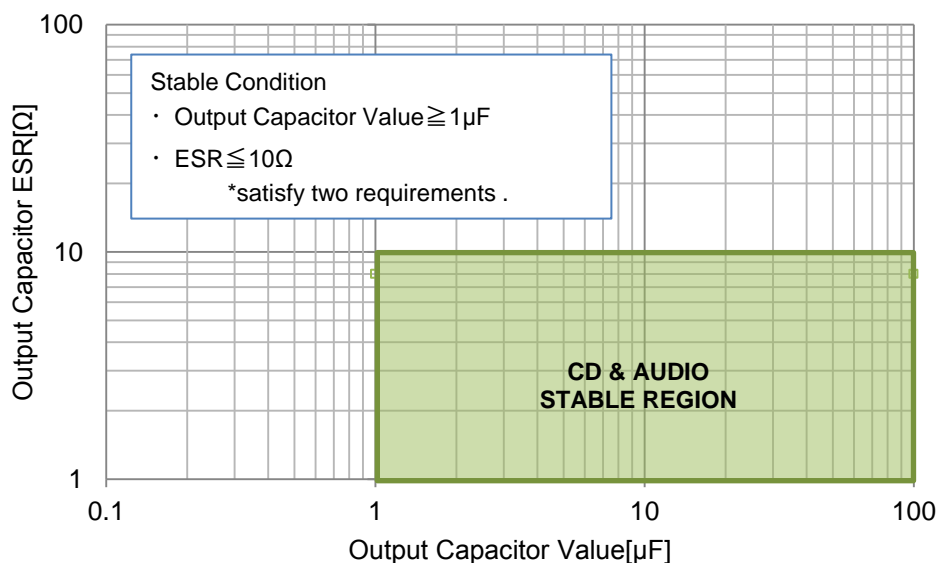

Fig59. CD & AUDIO STABLE REGION

Make sure that output capacitors is higher than 1uF and meets the condition of ESR, in which voltage/temperature fluctuation and unit differences are taken into consideration. Moreover, RF characteristics of electrolytic capacitor should be sufficient.

\*The above data is based on the result of the evaluation using our evaluation board under the specified conditions.

\*Oscillation tolerance is influenced by PCB layout, connection, parasitic capacitance and inductance. Therefore, make sure to use the system that will actually be offered to the market and define a constant after a sufficient evaluation.

## LV5680P Application Note

### Functional Description

The LV5680P is a multiple output voltage regulator with two power switches, suitable for use in car audio system.

#### VCC

This IC has the tolerance value of 50V against VCC peak surge voltage, but for more safety set design, adding power clamp, such as power zenner diode, on battery connected line is recommended in order to absorb applied surge.

This IC has no protection against battery reverse connection, so adding Schottky diode is recommended to prevent a negative voltage.

#### Linear Regulators

All regulators in LV5680P are low dropout outputs, because the output stage of all regulators is PLDMOS.

When you select output capacitors for linear regulators, you should consider three main characteristics: startup delay, transient response and loop stability. The capacitor values and type should be based on cost, availability, size and temperature constraints. Tantalum, Aluminum electrolytic, Film, or Ceramic capacitors are all acceptable solutions. However, attention must be paid to ESR constraints. The aluminum electrolytic capacitor is the least expensive solution, but if the circuit operates at low temperatures(-25 to -40 °C), both the value and ESR of the capacitor will vary considerably. The capacitor manufacturer's datasheet usually provides this information.

#### VDD5V regulator (5.0V, 0.2A)

When VCC is applied, VDD5V output is active regardless of CTRL states.

VDD5V output supplies the current to SW5V and ACC5V output. Therefore, the current supply capability of VDD5V output and its other electrical characteristics are affected by the condition of SW5V and ACC5V output.

The over-current limiting circuit of VDD5V, SW5V, and ACC5V is common. So when the

total output current value of three terminals reaches the limit value, the over-current limiting circuit operates.

#### CD regulator (8.0V, 1.3A)

When CTRL2 is "H", CD output is active. CD output has the highest current capability of four regulators in LV5680P.

#### AUDIO regulator (8-9V, 0.3A)

When CTRL2 is "M" & "H", AUDIO output is active. AUDIO output should set the output voltage by external resistance. For the setting method of the voltage, please refer to the explanation of this application note p.22.

#### ILM regulator (8-12V, 0.3A)

When CTRL1 is "M1", "M2" & "H", ILM output is active. ILM output voltage can be adjusted by external resistance between ILM and ILM\_F. If there is no external resistance, ILM output voltage is 12V by built-in resistance. For the setting method of the voltage, please refer to the explanation of this application note p.22.

#### EXT & ANT high-side switches

The two high-side power switches connected to VCC are a 350mA output (EXT) and a 300mA output (ANT).

If these outputs are connected to inductive load or loads which have different ground potential, diodes (D2 and D4 in Fig.4) are necessary to protect the device from negative voltage.

#### SW5V switch

This high-side switch connected to VDD5V is a 200mA output. When CTRL2 is "M" & "H", SW5V output is active. A pull-down resistance (50kΩ) is connected between SW5V and GND.

#### ACC detector circuit

When ACC input voltage is over 3V (typ), ACC5V output is active. ACC5V output is a high-side switch connected to VDD5V. A pull-down resistance (50kΩ) is connected between ACC5V and GND.

The ACC detection voltage has hysteresis characteristics, and the hysteresis value is



## LV5680P Application Note

0.3V (typ). The ACC input has a pull-down resistance, and this resistance value is 60k $\Omega$ . ACC terminal is high-voltage input as well as VCC terminal.

### **CTRL1, 2 input**

CTRL1 accepts four input values (L/M1/M2/H), and CTRL2 accepts three input values (L/M/H). CTRL1 & CTRL2 have a pull-down resistance, and this resistance value is 500k $\Omega$ .

Logic table is shown at p.19.

### **Protection**

#### **Thermal Shutdown**

To protect the device from overheating a thermal shutdown circuit is included. If the junction temperature reaches approximately 175 °C (typ), all outputs are turned off regardless of CTRL state. Outputs remain disabled until the junction temperature drops below 145°C(typ)(automatic restoration).

The thermal shutdown circuit does not guarantee the protection of the final product because it operates out of maximum rating (exceeding  $T_{jmax}=150^{\circ}C$ ).

#### **Current Limiting**

When the each output becomes in over load condition, the device limits the output current. All outputs are also protected against short circuit by fold back current limiter.

#### **Overvoltage**

The device is protected against load dump. When VCC voltage exceeds 21V, the device detects over voltage condition and turns all the outputs off except VDD to protect the device. If

VCC voltage gets below 21V, outputs are automatically restored.

### **TEST Procedure**

#### **Line regulation**

Line regulation is defined as the maximum change in output voltage as the input voltage is varied through the specified range. It is measured by changing the input voltage and measuring the minimum/maximum voltage of the output. Line regulation is defined as the difference between maximum and minimum voltage.

#### **Load regulation**

Load regulation is defined as the maximum change in output voltage as the load current is varied through the specified range. It is measured by changing the load current and measuring the minimum/maximum voltage of the output. Load regulation is defined as the difference between maximum and minimum voltage.

#### **Dropout voltage**

Dropout voltage is defined as the minimum input-to-output differential voltage at the specified load current required by the regulator to keep the output voltage in regulation. It is measured by reducing input voltage until the output voltage drops below the nominal value.

#### **Ripple rejection**

Ripple rejection is defined as the ratio of input ripple amplitude versus that of output.

## LV5680P Application Note

LV5680P is used, before the set design, must check the following

### 1. Absolute Maximum Rating (Common notes to general semiconductor device)

Stresses exceeding Maximum Ratings may damage the device. If a IC is applied stresses exceeding Maximum Ratings, a IC might smoke or fire by the breakdown and the overheating.

We recommend to derating design for reducing failure rate of device. A guide of general derating design is described below.

- (1) Stress Voltage: 80% or less for Abs Max voltage.
- (2) Maximum rating current: 80% or less for Abs Max Io.
- (3) Temperature: 80% or less for Temperatures rating.

### 2. Recommended Operating Range

When LV5680P was used within Recommended Operating Range and Temperature Rating, unless otherwise specified, we do not guarantee the specified value in all temperature ranges. As long as the IC is at operation temperature range, IC's characteristic doesn't change suddenly. Operating conditions of the input voltage and the output current are limited by the chip maximum junction temperature ( $T_{jmax}$ ). Please decide the value of the input voltage and the output current so as not to exceed  $T_{jmax}$ .

### 3. Output Capacitor

Between GND and each output, please be sure to put capacitor to prevent oscillation. Because abrupt changes of input voltage and output load interfere in the output voltage, make sure to use the system that will actually be offered to the market and define the output capacitor after a sufficient evaluation. When selecting the capacitor, to ensure the required minimum capacity over all operating conditions of the application, it is necessary to consider the influence of a temperature and a applied voltage on the capacity value.

Please design the PCB pattern that the output terminal and the capacitor are located as close as possible.

### 4. Parasitic Devices

Output Power MOS-FET driver has, in device structure, parasitic diode like the figure below. Because in normal operating the input voltage is higher than the output voltage, the parasitic diode is reverse bias. If the output is higher than the input at abnormal operating, a current flows from the output to the input, because the parasitic diode is forward biased.

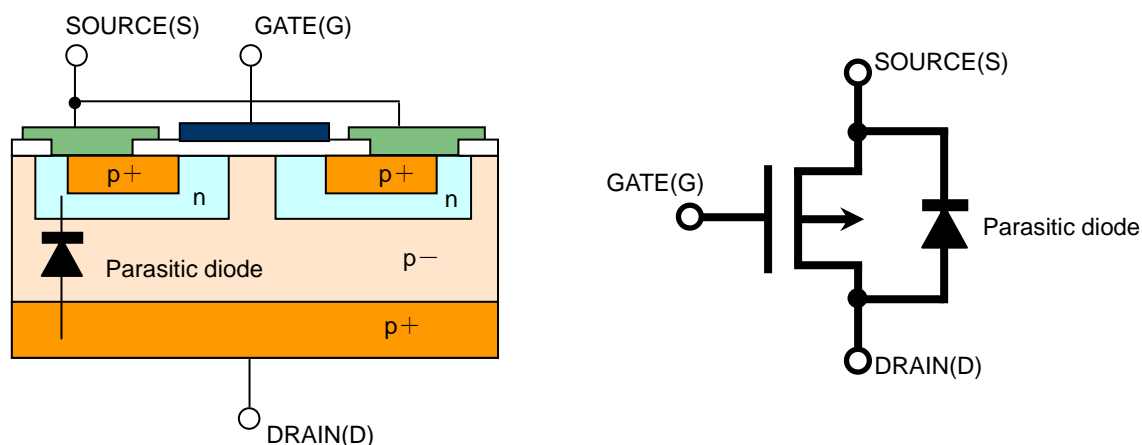

## LV5680P Application Note

### 5. Over-Current Protection

Each channel has an Over-Current Protection (OCP) circuit which is the "Fold-Back" type, OCP circuit prevent IC's break down at an over current condition. This circuit is useful against sudden over current, but use of continuous operation is not allowed.

The limit value of output current is changed by ambient temperature and production tolerance. However, the limiting value doesn't fall below the output maximum current defined by the specification. When the output current uses it exceeding the maximum current, the OCP circuit might operate in some situations. Please design the equipment, to be sure than a specified value. Please design the output current to use without fail below a specified maximum value.

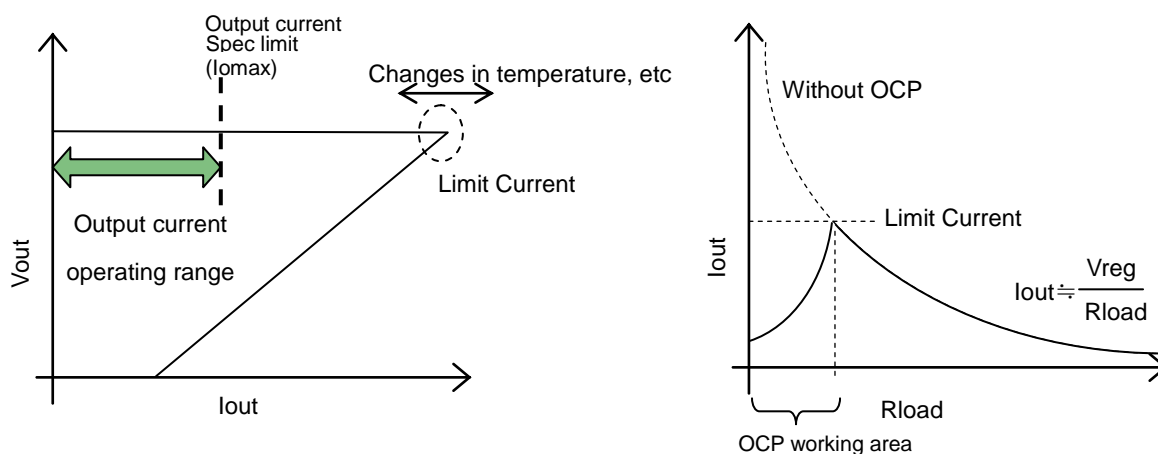

### 6. Over-Voltage Protection

When VCC voltage exceeds 21V, the device detects over voltage condition and shuts down all output but "VDD" to protect the device.

The peak voltage value (V<sub>cc peak</sub>) changes depending on Surge-waveform condition. Adding power clamp, such as power zener diode, on battery connected line is recommended in order to absorb applied surge.

### 7. Thermal shut-down

This IC built-in thermal shut-down circuit to prevent from thermal damage. If the state to exceed the Absolute Maximum Rating of the power dissipation continues, and the chip temperature (Junction temperature: T<sub>j</sub>) reaches 175°C, the thermal shut-down circuit operates. When the thermal shut-down circuit operates, all outputs are turned off regardless of CTRL state. Outputs remain disabled until the junction temperature drops below 145°C (typ) (automatic restoration). If the operating condition is not changing, the output repeats on and off. The output seems to oscillate.

\* The protector functions only improve the IC's tolerance and they do not guarantee the safety of the IC if used under the conditions out of safety range or ratings. Use of the IC such as use under over-current protection range or thermal shutdown state may degrade the IC's reliability and eventually damage the IC.

### 8. Notes on Installation

Package "HZIP15J", there are some places where metal is exposed except terminals and a heat sink. This includes the one connecting with the function pin. Especially, when the mounting hardware covers IC, do not bring "②" & "③" (in below figure) into contact with mounting hardware. The potential of point "①" as well as the heat sink is equal to GND.

# LV5680P Application Note

• HZIP15J

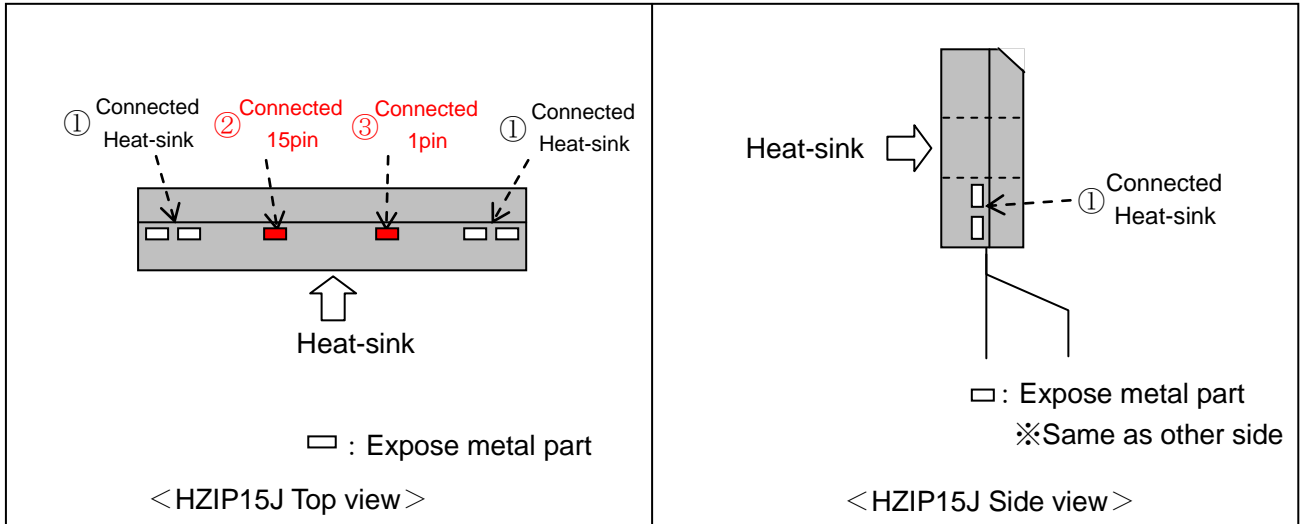

**\*Caution :Do not bring "②" & "③" into contact with mounting hardware.**

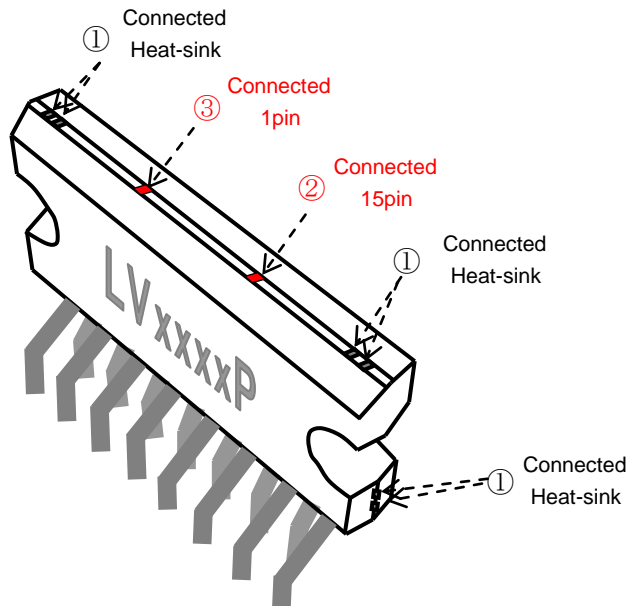

## 9. Application Circuit Example

IC's operating characteristics are influenced by PCB layout, connection, parasitic capacitance and inductance. Therefore, make sure to use the system that will actually be offered to the market and define a constant after a sufficient evaluation.

## LV5680P Application Note

ON Semiconductor and the ON logo are registered trademarks of Semiconductor Components Industries, LLC (SCILLC). SCILLC owns the rights to a number of patents, trademarks, copyrights, trade secrets, and other intellectual property. A listing of SCILLC's product/patent coverage may be accessed at [www.onsemi.com/site/pdf/Patent-Marking.pdf](http://www.onsemi.com/site/pdf/Patent-Marking.pdf). SCILLC reserves the right to make changes without further notice to any products herein. SCILLC makes no warranty, representation or guarantee regarding the suitability of its products for any particular purpose, nor does SCILLC assume any liability arising out of the application or use of any product or circuit, and specifically disclaims any and all liability, including without limitation special, consequential or incidental damages. "Typical" parameters which may be provided in SCILLC data sheets and/or specifications can and do vary in different applications and actual performance may vary over time. All operating parameters, including "Typicals" must be validated for each customer application by customer's technical experts. SCILLC does not convey any license under its patent rights nor the rights of others. SCILLC products are not designed, intended, or authorized for use as components in systems intended for surgical implant into the body, or other applications intended to support or sustain life, or for any other application in which the failure of the SCILLC product could create a situation where personal injury or death may occur. Should Buyer purchase or use SCILLC products for any such unintended or unauthorized application, Buyer shall indemnify and hold SCILLC and its officers, employees, subsidiaries, affiliates, and distributors harmless against all claims, costs, damages, and expenses, and reasonable attorney fees arising out of, directly or indirectly, any claim of personal injury or death associated with such unintended or unauthorized use, even if such claim alleges that SCILLC was negligent regarding the design or manufacture of the part. SCILLC is an Equal Opportunity/Affirmative Action Employer. This literature is subject to all applicable copyright laws and is not for resale in any manner.