

ON Semiconductor

Is Now

onsemi™

To learn more about onsemi™, please visit our website at
www.onsemi.com

onsemi and **onsemi** and other names, marks, and brands are registered and/or common law trademarks of Semiconductor Components Industries, LLC dba "**onsemi**" or its affiliates and/or subsidiaries in the United States and/or other countries. **onsemi** owns the rights to a number of patents, trademarks, copyrights, trade secrets, and other intellectual property. A listing of **onsemi** product/patent coverage may be accessed at www.onsemi.com/site/pdf/Patent-Marking.pdf. **onsemi** reserves the right to make changes at any time to any products or information herein, without notice. The information herein is provided "as-is" and **onsemi** makes no warranty, representation or guarantee regarding the accuracy of the information, product features, availability, functionality, or suitability of its products for any particular purpose, nor does **onsemi** assume any liability arising out of the application or use of any product or circuit, and specifically disclaims any and all liability, including without limitation special, consequential or incidental damages. Buyer is responsible for its products and applications using **onsemi** products, including compliance with all laws, regulations and safety requirements or standards, regardless of any support or applications information provided by **onsemi**. "Typical" parameters which may be provided in **onsemi** data sheets and/or specifications can and do vary in different applications and actual performance may vary over time. All operating parameters, including "Typicals" must be validated for each customer application by customer's technical experts. **onsemi** does not convey any license under any of its intellectual property rights nor the rights of others. **onsemi** products are not designed, intended, or authorized for use as a critical component in life support systems or any FDA Class 3 medical devices or medical devices with a same or similar classification in a foreign jurisdiction or any devices intended for implantation in the human body. Should Buyer purchase or use **onsemi** products for any such unintended or unauthorized application, Buyer shall indemnify and hold **onsemi** and its officers, employees, subsidiaries, affiliates, and distributors harmless against all claims, costs, damages, and expenses, and reasonable attorney fees arising out of, directly or indirectly, any claim of personal injury or death associated with such unintended or unauthorized use, even if such claim alleges that **onsemi** was negligent regarding the design or manufacture of the part. **onsemi** is an Equal Opportunity/Affirmative Action Employer. This literature is subject to all applicable copyright laws and is not for resale in any manner. Other names and brands may be claimed as the property of others.

TND6258/D

20 W Direct AC LED Driver Analog and Phase-cut Dimming



ON Semiconductor®

www.onsemi.com

REFERENCE DESIGN

Introduction

This Reference Design includes specifications, theory of operation, testing, and construction of four versions of reference design, based on the NCL30170 Direct AC Drive LED Driver. The Reference Design versions are for 20 W, with accurate current regulation and low THD. Reference Designs are available for the four combinations of high line and low line, and ADIM and PCDIM.

Table 1.

Input Voltage	108 – 132 V ac	Low line ADIM/PCDIM
	198 – 264 V ac	High line ADIM/PCDIM
Line Frequency	50 Hz / 60 Hz	
Output Power	20 W	Typ.
Power Factor (Maximum LED Output)	0.95	Min
THD (Nominal Input Voltage)	10%	Max
Line Regulation	± 2%	
Analog Dimming Range	< 5 %	
Start Up Time	< 200 msec	Typ.
Percent Flicker	< 30%	With E-cap
Lighting Surge	CM: ±2.5 kV (Line to PE) DM: ±2.5 kV (Line to Neutral)	ANSI/IEEE C62.41-1991 Class A
EMI	Conducted	9 kHz – 30 MHz

Key Features

- Accurate Constant LED Current across input voltage range
- Selectable LED Channel counts using advanced topology
- Excellent Power Factor and THD with sinusoidal current shape
- Wide Analog dimming range < 5 %
- Excellent Phase-cut dimmer compatibility
- Protections
 - ◆ Input Over Voltage Protection
 - ◆ Thermal Shut Down
 - ◆ Sensing Resistor Short Protection

TND6258/D

SCHEMATIC FOR LOW LINE 20 W ADIM

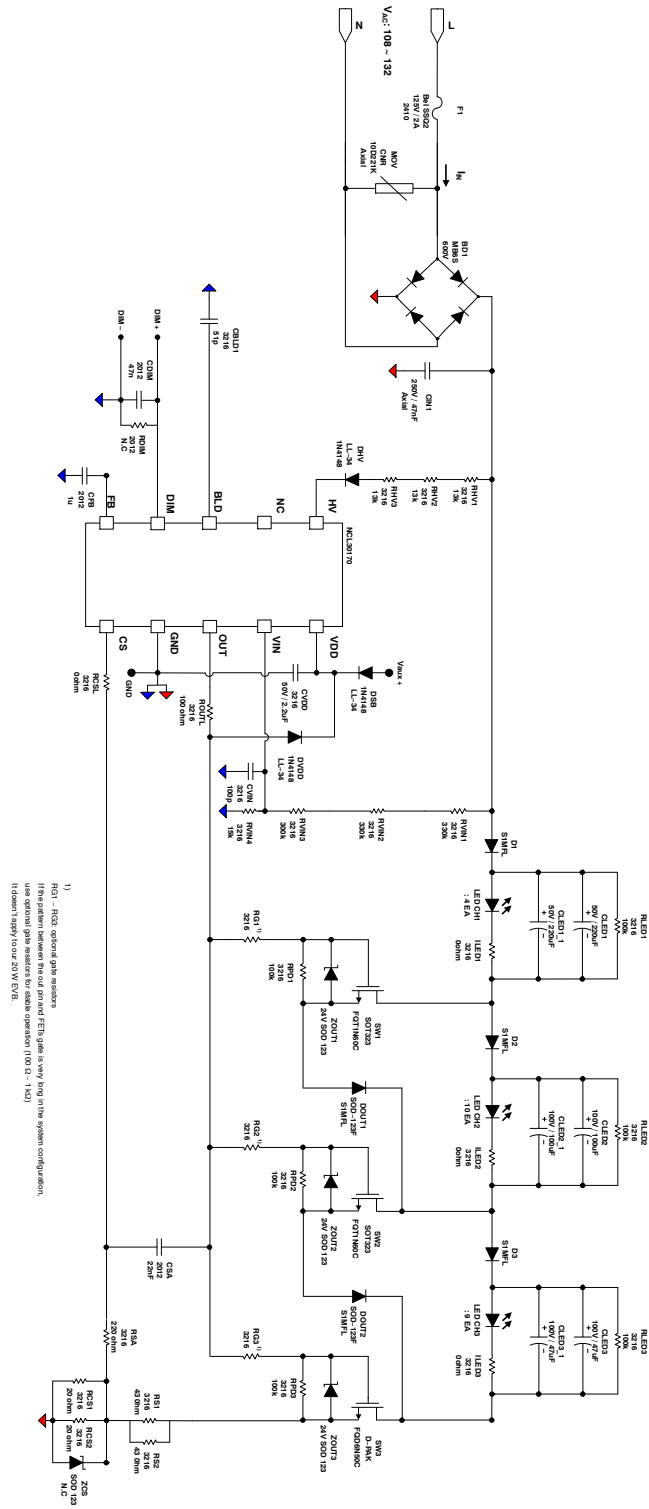

TND6258/D

Table 2. BILL OF MATERIALS (BOM)

Part Reference	Part Description	Q'ty	Vendor	Note
PCB	NCL30170 20 W ADIM EVB	1	ANY	
NCL30170	IC SOIC10	1	ON Semiconductor	Controller
F1	fast Acting 125 V 2 A SSQ2 2410	1	Bel fuse	
MOV	CNR10D221K	1	ANY	
BD1	Bridge diode 600 V 0.5 A, MB6S SOIC-4	1	ON Semiconductor	
ZOUT1-3	SMD 24V Zener Diode, SOD-123	3	ON Semiconductor	
DHV, DSB, DVDD	SMD Diode LL4148 (LL-34)	3	ON Semiconductor	DSB : option (external VDD)
SW1, SW2	MOSFET FQT1N60C SOT-223	2	ON Semiconductor	
SW3	MOSFET FQD6N50C D-PAK	1	ON Semiconductor	
DOUT1, DOUT2, D1-3	SMD Diode S1MFL, SOD-123F	5	ON Semiconductor	
RHV1, RHV2, RHV3	3216 Resistor, 13 k Ω	3	ANY	
ILED1-3, RCSL	3216 Resistor, 0 Ω	4	ANY	
RVIN1, RVIN2	3216 Resistor, 330 k Ω	2	ANY	
RVIN3	3216 Resistor, 300 k Ω	1	ANY	
RVIN4	3216 Resistor, 15 k Ω	1	ANY	
RPD1-3, RLED1-3	3216 Resistor, 100 k Ω	6	ANY	
RCS1, RCS2	3216 Resistor, 20 Ω	2	ANY	
RSA	3216 Resistor, 220 Ω	1	ANY	
RS1, RS2	3216 Resistor, 43 Ω	2	ANY	
ROUTL	3216 Resistor, 100 Ω	1	ANY	
CIN1	Axial Flim Capacitor, 47 nF / 250 V	1	ANY	
CVDD	3216 Capacitor, 50 V 2.2 μ F	1	ANY	
CBLD1	3216 Capacitor, 51 pF	1	ANY	
CVIN	3216 Capacitor, 100 pF	1	ANY	
CLED 1, CLED 1_1	SMD Al.capacitor 50 V 220 μ F BXJ J10	2	SAMYOUNG	
CLED 2, CLED 2_1	SMD Al.capacitor 100 V 100 μ F BXJ K14	2	SAMYOUNG	
CLED 3, CLED 3_1	SMD Al.Capacitor 100 V 47 μ F MVK J10	2	SAMYOUNG	
CDIM	2012 Capacitor 47 nF	1	ANY	
CSA	2012 Capcitor 22 nF	1	ANY	
CFB	2012 Capacitor 1 μ F	1	ANY	
LED Configuration	LED Luxeon 3030 2D 6 V 240 mA Default LED configuration : 4-10-9 LED max counts (8-15-15)	23	Luxeon	

TND6258/D

Table 3. BILL OF MATERIALS (BOM)

Part Reference	Part Description	Q'ty	Vendor	Note
PCB	NCL30170 20 W ADIM EVB	1	ANY	
NCL30170	IC SOIC10	1	ON Semiconductor	Controller
F1	350 V 2.5 A 0679H2500	1	Bel fuse	
MOV	10D391K	1	ANY	
BD1	Bridge diode 600 V 0.5 A, MB6S SOIC-4	1	ON Semiconductor	
ZOUT1-3	SMD 24 V Zener Diode, SOD-123	3	ON Semiconductor	
DHV, DSB, DVDD	SMD Diode LL4148 (LL-34)	3	ON Semiconductor	DSB : option (external VDD)
SW1, SW2	MOSFET FQT1N60C SOT-223	2	ON Semiconductor	
SW3	MOSFET FQD6N50C D-PAK	1	ON Semiconductor	
DOUT1, DOUT2, D1-3	SMD Diode S1MFL, SOD-123F	5	ON Semiconductor	
RHV1, RHV2, RHV3	3216 Resistor, 13 k Ω	3	ANY	
ILED1-3, RCSL	3216 Resistor, 0 Ω	4	ANY	
RVIN1, RVIN2	3216 Resistor, 330 k Ω	2	ANY	
RVIN3	3216 Resistor, 300 k Ω	1	ANY	
RVIN4	3216 Resistor, 7.5 k Ω	1	ANY	
RPD1-3, RLED1-3	3216 Resistor, 100 k Ω	6	ANY	
RCS1, RCS2	3216 Resistor, 36 Ω	2	ANY	
RSA	3216 Resistor, 220 Ω	1	ANY	
RS1, RS2	3216 Resistor, 68 Ω	2	ANY	
ROUTL	3216 Resistor, 100 Ω	1	ANY	
CIN1	Axial Flim Capacitor, 68 nF / 450 V	1	ANY	
CVDD	3216 Capacitor, 50 V 2.2 μ F	1	ANY	
CBLD1	3216 Capacitor, 51 pF	1	ANY	
CVIN	3216 Capacitor, 100 pF	1	ANY	
CLED 1	SMD Al.capacitor 100 V 47 μ F MVK J10	1	SAMYOUNG	
CLED 2, CLED 2_1	SMD Al.capacitor 160 V 33 μ F MVK K14	2	SAMYOUNG	
CLED 3, CLED 3_1	SMD Al.Capacitor 160 V 33 μ F MVK K14	2	SAMYOUNG	
CDIM	2012 Capacitor 47 nF	1	ANY	
CSA	2012 Capcitor 22 nF	1	ANY	
CFB	2012 Capacitor 1 μ F	1	ANY	
LED Configuration	LED Luxeon 3030 2D 6 V 240 mA Default LED configuration : 9-19-16 LED max counts (14-21-27)	44	Luxeon	

TND6258/D

BILL OF MATERIALS (BOM)

Table 4. BILL OF MATERIALS (BOM)

Part Reference	Part Description	Q'ty	Vendor	Note
PCB	NCL30170 20 W PCDIM EVB	1	ANY	
NCL30170	IC SOIC10	1	ON Semiconductor	controller
F1	125 V 2 A SSQ 2410	1	Bel fuse	
MOV	CNR10D221K	1	ANY	
BD1	Bridge diode 600 V 0.5 A, MB6S SOIC-4	1	ON Semiconductor	
ZPBLD, ZBLD	SMD 22 V Zener Diode, SOD-123	2	ON Semiconductor	
ZOUT1-3	SMD 24 V Zener Diode, SOD-123	3	ON Semiconductor	
DHV, DPBLD, DVDD	SMD Diode LL4148 (LL-34)	3	ON Semiconductor	
SW1, SW2, SWBLD	MOSFET FQT1N60C SOT-223	3	ON Semiconductor	
SW3	MOSFET FQD6N50C D-PAK	1	ON Semiconductor	
DOUT1, DOUT2, D1-3	SMD Diode S1MFL, SOD-123F	5	ON Semiconductor	
RHV1-3	3216 Resistor, 13 k Ω	3	ANY	
RPBLD1, RPBLD2	3216 Resistor, 1.5 k Ω	2	ANY	
ILED1-3, RCSL, RPBLD3	3216 Resistor, 0 Ω	5	ANY	
RVIN1	3216 Resistor, 330 k Ω	1	ANY	
RVIN2	3216 Resistor, 300 k Ω	1	ANY	
RVIN3	3216 Resistor 270 k Ω	1	ANY	
RVIN4	3216 Resistor, 12 k Ω	1	ANY	
RBLD1, RBLD2	3216 Resistor 360 Ω	2	ANY	
RPD1-3, RLED1-3, RBLD3	3216 Resistor, 100 k Ω	7	ANY	
RCS1, RCS2	3216 Resistor, 20 Ω	2	ANY	
RSA	3216 Resistor, 220 Ω	1	ANY	
RS1, RS2	3216 Resistor, 43 Ω	2	ANY	
ROUTL	3216 Resistor, 100 Ω	1	ANY	
RDIM	2012 Resistor, 430 k Ω	1	ANY	
CIN1	Axial Flim Capacitor, 47 nF / 250 V	1	ANY	
CPBLD	Axial Flim Capacitor, 150 nF/ 250V	1	ANY	
CVDD	3216 Capacitor, 50 V 4.7 μ F	1	ANY	
CVIN, CBLD1	3216 Capacitor, 820 pF	2	ANY	
CBLD2	3216 Capacitor, 180 pF	1	ANY	
CLED 1, CLED 1_1	SMD Al.capacitor 50 V 220 μ F BXJ J10	2	SAMYOUNG	
CLED 2, CLED 2_1	SMD Al.capacitor 100 V 100 μ F BXJ K14	2	SAMYOUNG	
CLED 3, CLED 3_1	SMD Al.Capacitor 100 V 47 μ F MVK J10	2	SAMYOUNG	
CDIM	2012 Capacitor 180 nF	1	ANY	
CSA	2012 Capcitor 22 nF	1	ANY	
CFB	2012 Capacitor 1 μ F	1	ANY	
LED Configuration	LED Luxeon 3030 2D 6 V 240 mA Default LED configuration : 4-10-9 LED max counts (8-15-15)	23	Luxeon	

TND6258/D

SCHEMATIC FOR HIGH LINE 20 W PCDIM

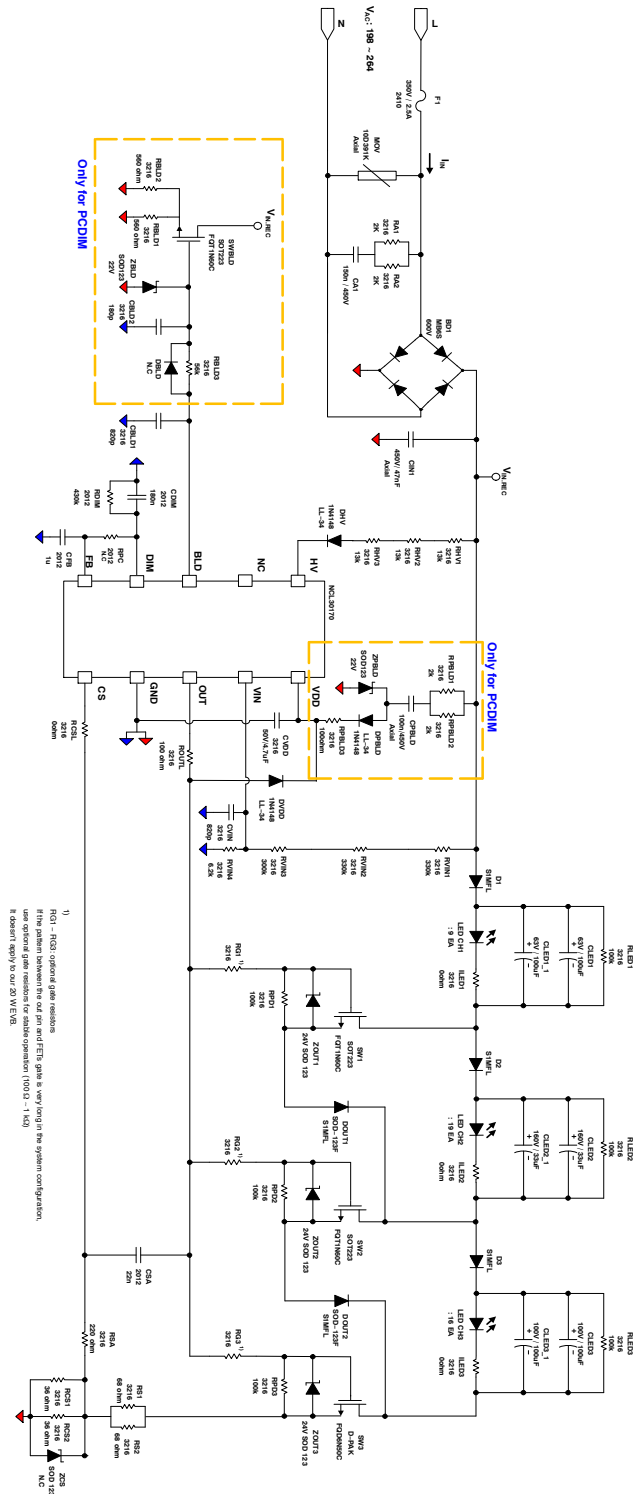

Figure 4. Schematic for High Line 20 W PCDIM

TND6258/D

Table 5. BILL OF MATERIALS (BOM)

Part Reference	Part Description	Q'ty	Vendor	Note
PCB	NCL30170 20 W PCDIM EVB	1	ANY	
NCL30170	IC SOIC10	1	ON Semiconductor	controller
F1	350 V 2.5 A 0679H2500	1	Bel fuse	
MOV	10D391K	1	ANY	
BD1	Bridge diode 600 V 0.5 A, MB6S SOIC-4	1	ON Semiconductor	
ZPBLD, ZBLD	SMD 22 V Zener Diode, SOD-123	2	ON Semiconductor	
ZOUT1-3	SMD 24 V Zener Diode, SOD-123	3	ON Semiconductor	
DHV, DPBLD, DVDD	SMD Diode LL4148 (LL-34)	3	ON Semiconductor	
SW1, SW2, SWBLD	MOSFET FQT1N60C SOT-223	3	ON Semiconductor	
SW3	MOSFET FQD6N50C D-PAK	1	ON Semiconductor	
DOU1, DOU2, D1-3	SMD Diode S1MFL, SOD-123F	5	ON Semiconductor	
RHV1-3	3216 Resistor, 13 k Ω	3	ANY	
RPBLD1-2 RA1-2	3216 Resistor, 2 k Ω	4	ANY	
ILED1-3, RCSL	3216 Resistor, 0 Ω	4	ANY	
RVIN1, RVIN2	3216 Resistor, 330 k Ω	2	ANY	
RVIN3	3216 Resistor, 300 k Ω	1	ANY	
RVIN4	3216 Resistor, 6.2 k Ω	1	ANY	
RBLD1, RBLD2	3216 Resistor 560 Ω	2	ANY	
RPD1-3, RLED1-3	3216 Resistor, 100 k Ω	6	ANY	
RBLD3	3216 Resistor, 56 k Ω	1	ANY	
RCS1, RCS2	3216 Resistor, 36 Ω	2	ANY	
RSA	3216 Resistor, 220 Ω	1	ANY	
RS1, RS2	3216 Resistor, 68 Ω	2	ANY	
ROUTL, RPBLD3	3216 Resistor, 100 Ω	2	ANY	
RDIM	2012 Resistor, 430 k Ω	1	ANY	
CA1	Axial Film Capacitor, 150 nF / 450V	1	ANY	
CIN1	Axial Film Capacitor, 47 nF / 450 V	1	ANY	
CPBLD	Axial Film Capacitor, 100nF/ 450V	1	ANY	
CVDD	3216 Capacitor, 50 V 4.7 μ F	1	ANY	
CVIN, CBLD1	3216 Capacitor, 820 pF	2	ANY	
CBLD2	3216 Capacitor, 180 pF	1	ANY	
CLED 1, CLED 1_1	SMD Al.capacitor 63 V 100 μ F BXJ J10	2	SAMYOUNG	
CLED 2, CLED 2_1	SMD Al.capacitor 160 V 33 μ F BXJ K14	2	SAMYOUNG	
CLED 3, CLED 3_1	SMD Al.Capacitor 100 V 100 μ F BXJ K14	2	SAMYOUNG	
CDIM	2012 Capacitor 180 nF	1	ANY	
CSA	2012 Capacitor 22 nF	1	ANY	
CFB	2012 Capacitor 1 μ F	1	ANY	
LED Configuration	LED Luxeon 3030 2D 6 V 240 mA Default LED configuration : 9-19-16 LED max counts (14-21-27)	44	Luxeon	

TND6258/D

PERFORMANCE

Test Data – Phase-cut Dimming Mode

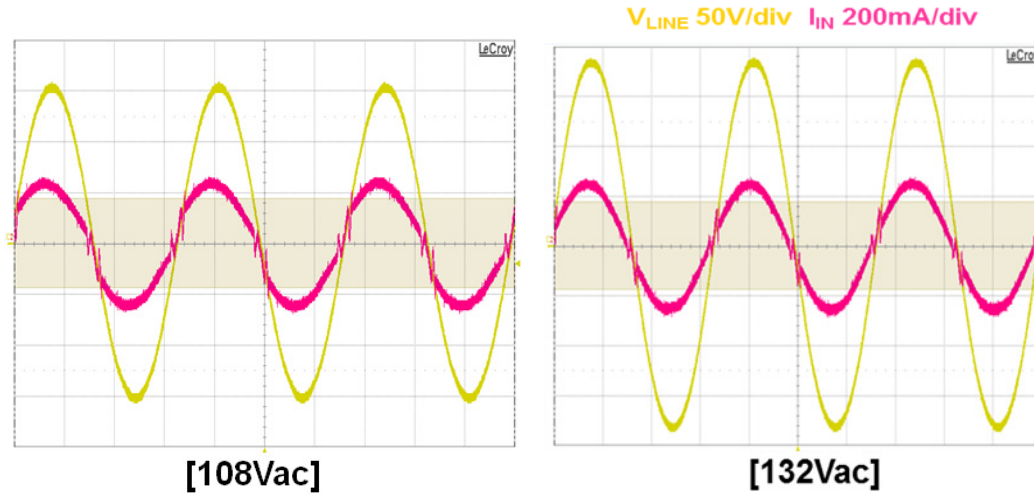

Input Condition [V _{ac} / freq]	Input Power [W]	PF	THD [%]
108 / 60Hz	17.9	0.99	8.5
120 / 60Hz	20.0	0.99	6.3
132 / 60Hz	22.8	0.99	5.7

Figure 5. Power Factor and THD Performance (Low Line PCDIM)

Input Condition [V _{ac} / freq]	Input Power [W]	PF	THD [%]
198 / 60Hz	18.29	0.95	11.2
220 / 60Hz	20.4	0.95	8.9
264 / 60Hz	25.26	0.95	6.4

Figure 6. Power Factor and THD Performance (High Line PCDIM)

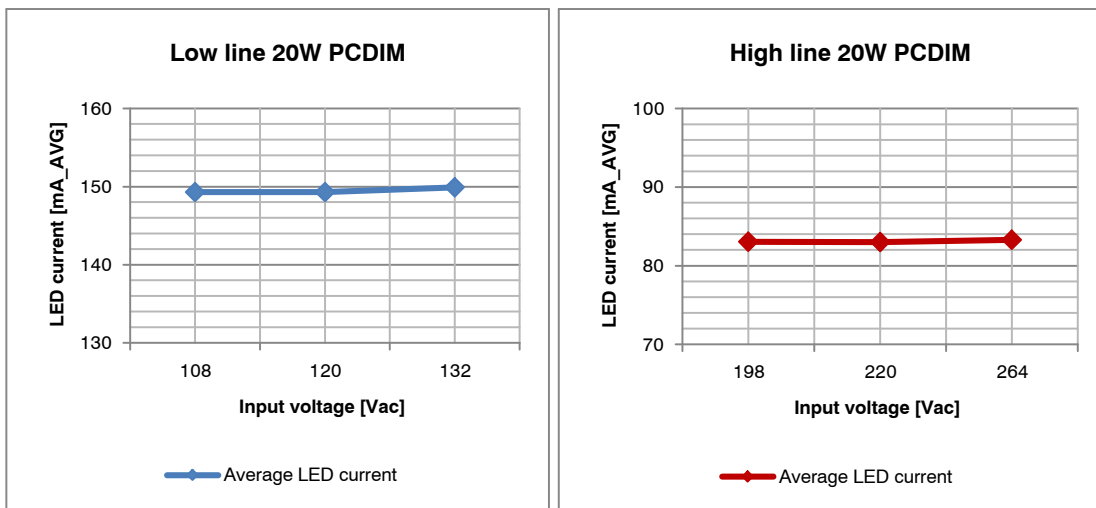

Figure 7. Line Regulation Performance (PCDIM)

TND6258/D

Dimming Performance

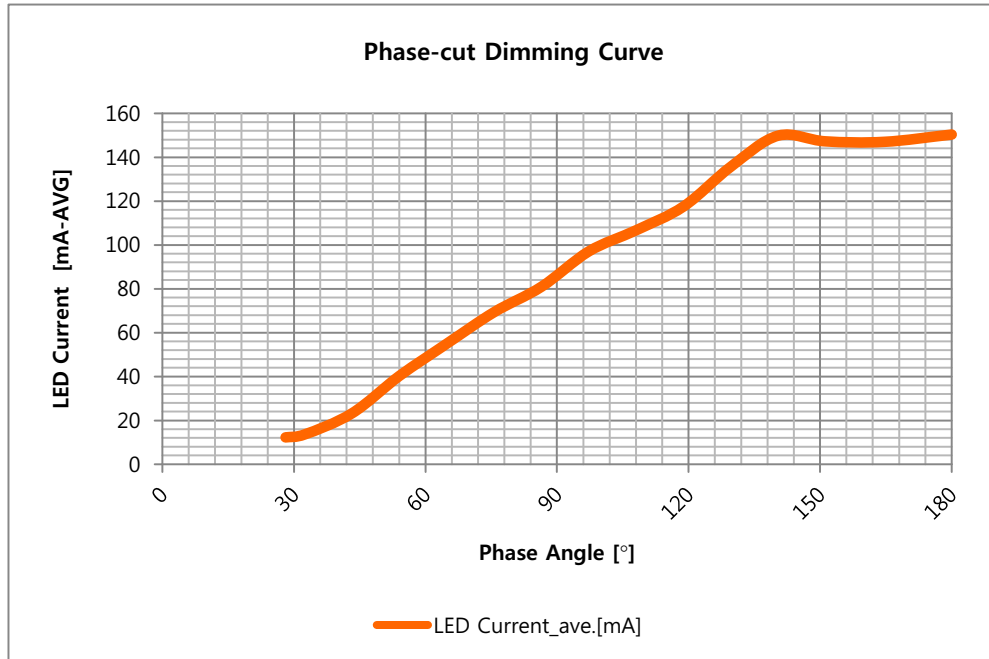

Figure 8. Dimming Curve for Phase-cut Dimmer (Low line PCDIM)

Table 6. TEST DIMMER : C20-6683-IW LEVITON

	Phase Angle [°]	LED Current Average [mA]	Pin [W]
Non Dim	180	150.3	19.98
Max PA	164	147.0	20.25
Step #1	150	147.2	20.77
Step #2	140	149.8	21.21
Step #3	130	135.7	19.35
Step #4	120	117.5	16.61
Step #5	110	106.7	14.78
Step #6	100	97.0	12.28
Step #7	85	80.9	9.69
Step #8	75	69.3	7.33
Step #9	65	54.9	5.44
Step #10	55	40.2	3.35
Step #11	45	23.2	1.67

Percent Flicker with Electrolytic Capacitor

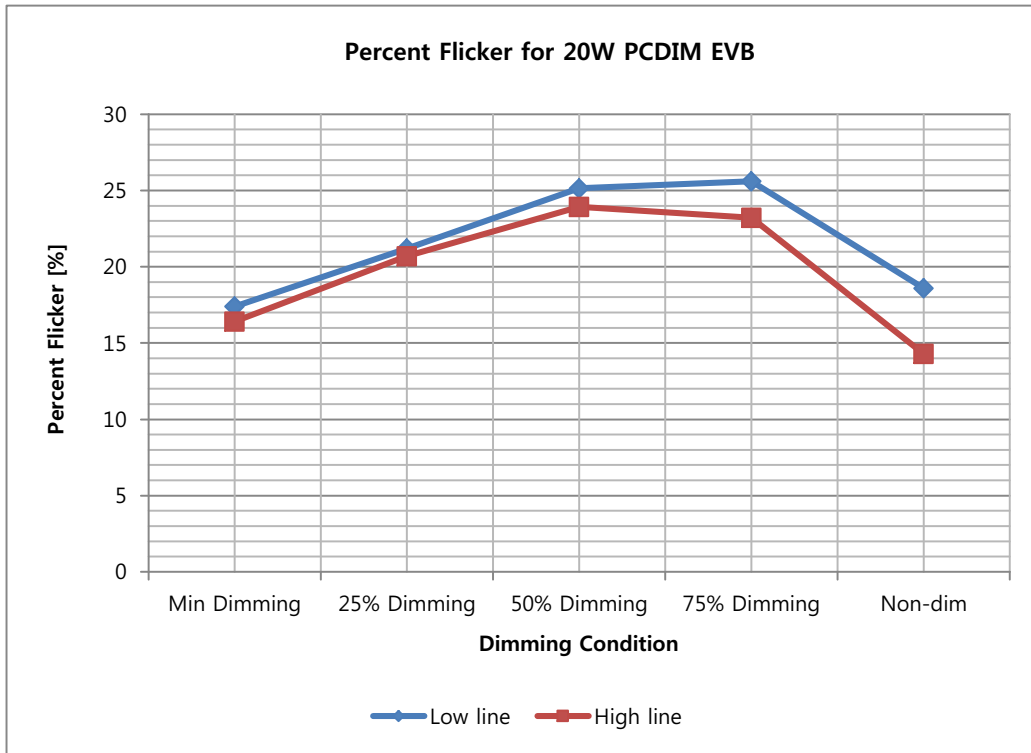
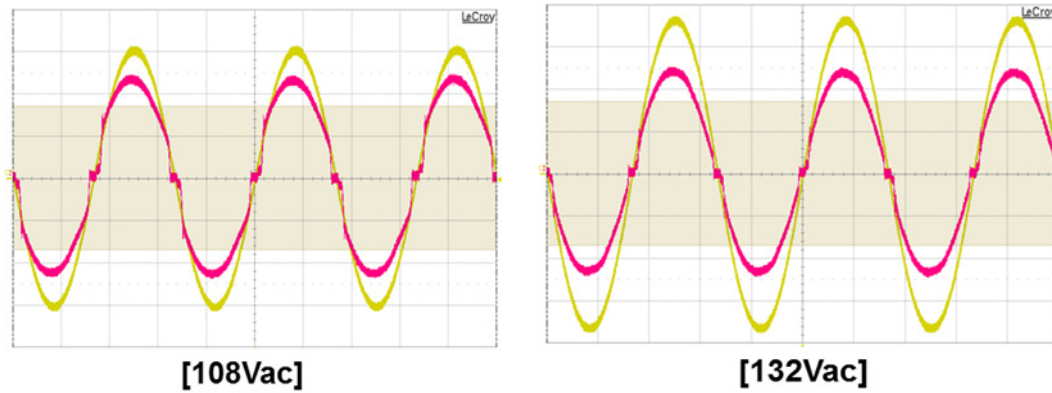

Figure 9. Percent Flicker Performance (PCDIM)

Test Data – Analog Dimming Mode

V_{LINE} 50V/div I_{IN} 100mA/div



Input Condition [V _{ac} / freq]	Input Power [W]	PF	THD [%]
108 / 60Hz	18.15	0.99	7.9
120 / 60Hz	20.32	0.99	6.7
132 / 60Hz	22.58	0.99	7.3

Figure 10. Power Factor and THD Performance (Low Line ADIM)

Input Condition [V _{ac} / freq]	Input Power [W]	PF	THD [%]
198 / 60Hz	18.61	0.99	9.5
220 / 60Hz	20.86	0.99	7.9
264 / 60Hz	25.54	0.99	7.6

Figure 11. Power Factor and THD Performance (High Line ADIM)

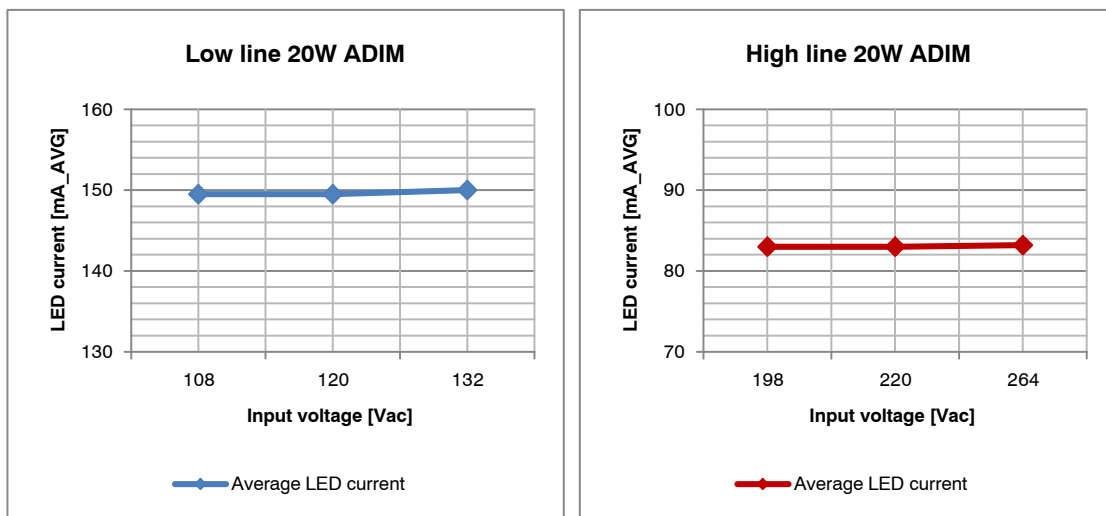

Figure 12. Line Regulation Performance (ADIM)

Dimming Performance

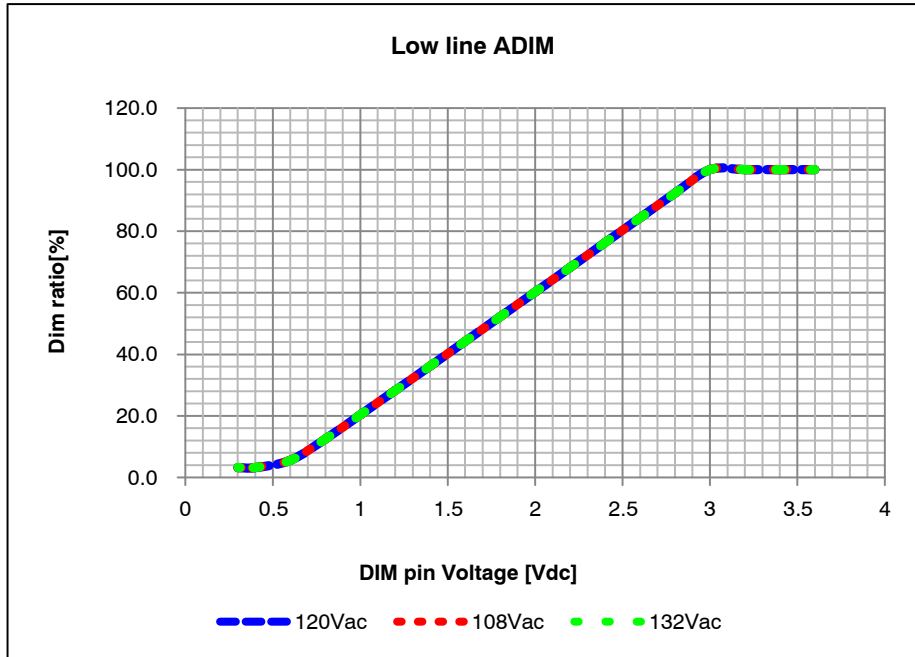

Figure 13. Analog Dimming Curve (Low Line 20 W)

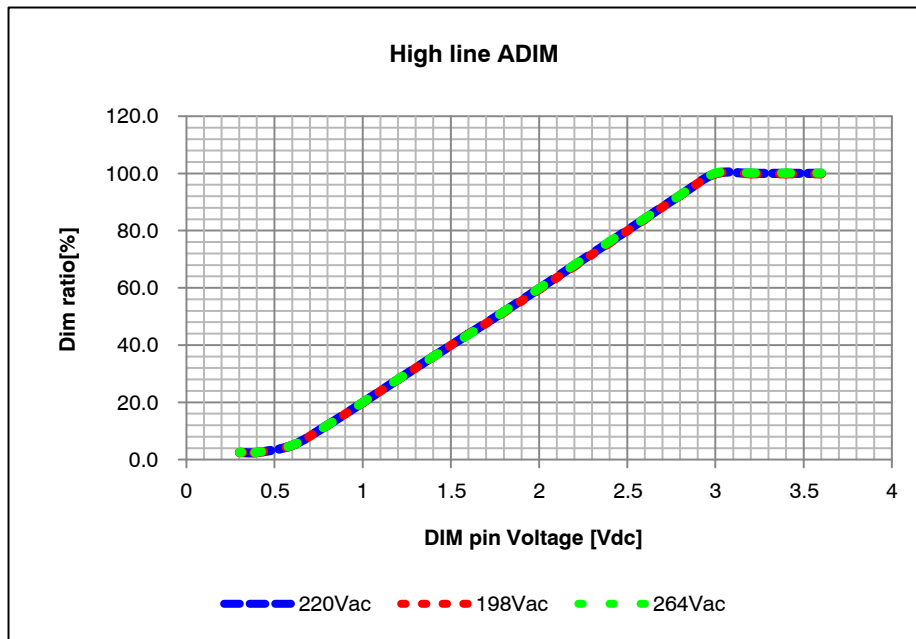

Figure 14. Analog Dimming Curve (High Line 20 W)

Percent Flicker with Electrolytic Capacitor

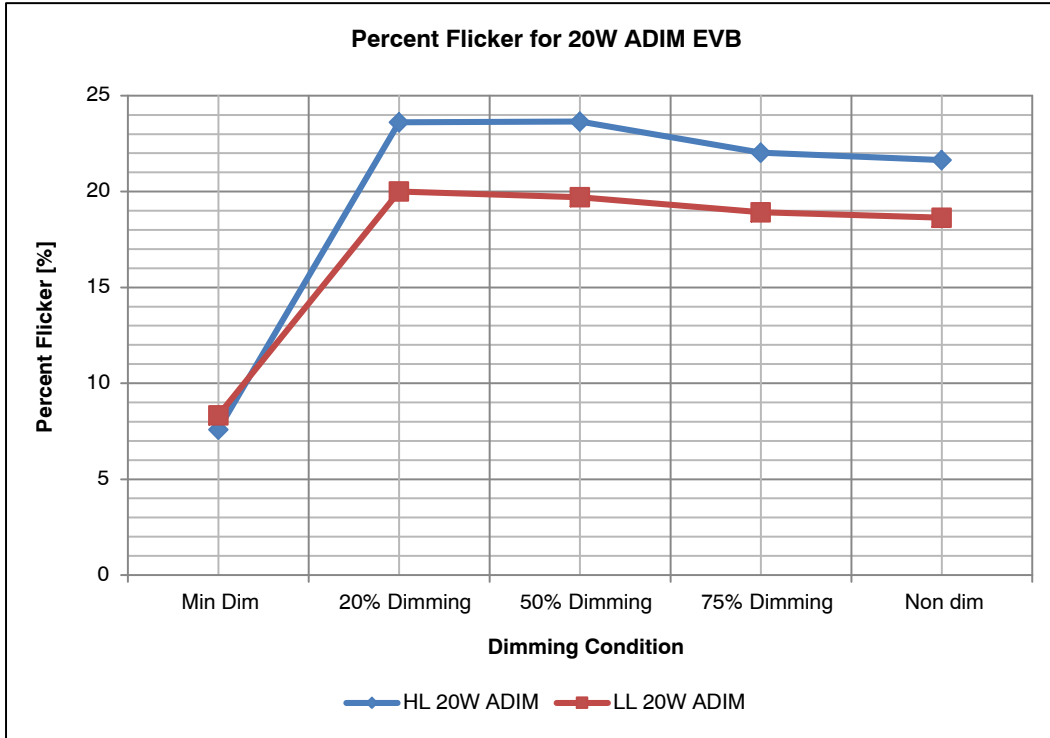
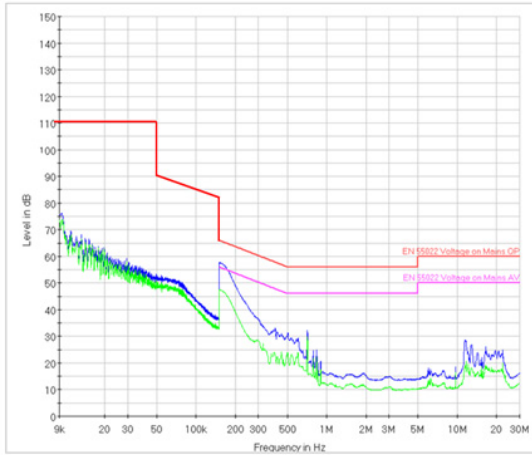
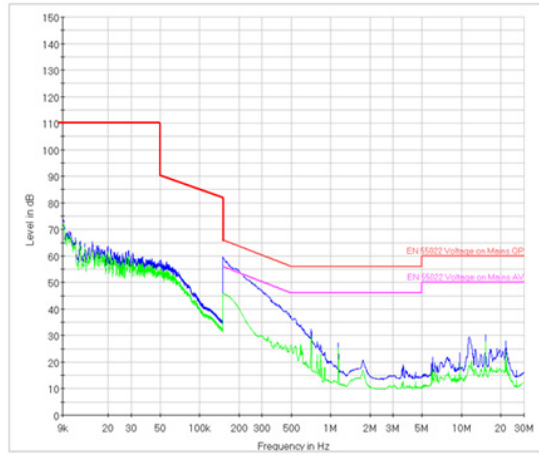

Figure 15. Percent Flicker Performance (ADIM)

Conducted EMI



[LL 20W ADIM]



[HL 20W ADIM]

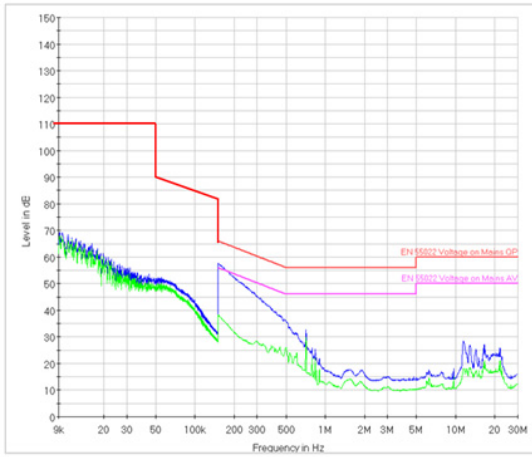

[LL 20W PCDIM]

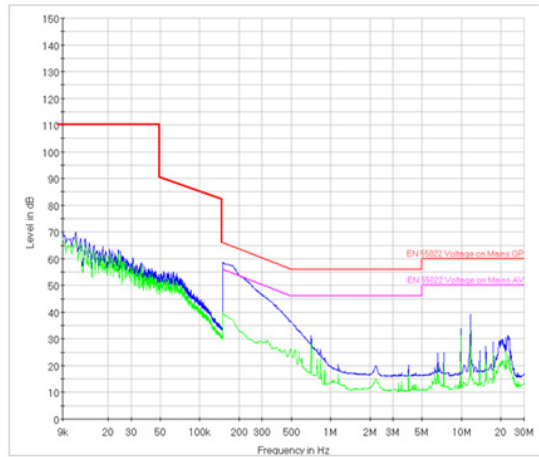

[HL 20W PCDIM]

Figure 16. EMI Test Result for NCL30170 20 W EVB

Surge Test

Test condition :

Boards mounted to 15 cm x 15 cm x 3 cm heatsink

Heatsink connected to Earth ground

DM: Differential Mode test applies surge between Line and Neutral

CM: Common Mode test applies surge between Line +

Neutral connected and Earth ground

Ring wave: 7 strikes / Combination wave: 3 strikes

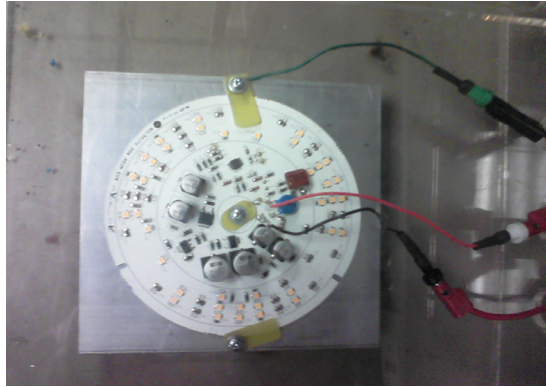

Figure 17. Surge Test (Ring Wave / Combination Wave)

Test Result for Combination Wave

Table 7.

Test EVB	Result	Surge Immunity Component
LL 20 W ADIM	± 2.5 kV passed	MOV10D221K (10pi)
LL 20 W PCDIM	± 2.5 kV passed	MOV10D221K (10pi)
HL 20 W ADIM	± 2.5 kV passed	MOV10D391K (10pi)
HL 20 W PCDIM	± 2.5 kV passed	MOV10D391K (10pi)

Test Result for Ring Wave

Table 8.

Test EVB	Result	Surge Immunity Component
LL 20 W ADIM	± 2.5 kV passed	MOV10D221K (10pi)
LL 20 W PCDIM	± 2.5 kV passed	MOV10D221K (10pi)
HL 20 W ADIM	± 2.5 kV passed	MOV10D391K (10pi)
HL 20 W PCDIM	± 2.5 kV passed	MOV10D391K (10pi)

ON Semiconductor and  are trademarks of Semiconductor Components Industries, LLC dba ON Semiconductor or its subsidiaries in the United States and/or other countries. ON Semiconductor owns the rights to a number of patents, trademarks, copyrights, trade secrets, and other intellectual property. A listing of ON Semiconductor's product/patent coverage may be accessed at www.onsemi.com/site/pdf/Patent-Marking.pdf. ON Semiconductor reserves the right to make changes without further notice to any products herein. ON Semiconductor makes no warranty, representation or guarantee regarding the suitability of its products for any particular purpose, nor does ON Semiconductor assume any liability arising out of the application or use of any product or circuit, and specifically disclaims any and all liability, including without limitation special, consequential or incidental damages. Buyer is responsible for its products and applications using ON Semiconductor products, including compliance with all laws, regulations and safety requirements or standards, regardless of any support or applications information provided by ON Semiconductor. "Typical" parameters which may be provided in ON Semiconductor data sheets and/or specifications can and do vary in different applications and actual performance may vary over time. All operating parameters, including "Typicals" must be validated for each customer application by customer's technical experts. ON Semiconductor does not convey any license under its patent rights nor the rights of others. ON Semiconductor products are not designed, intended, or authorized for use as a critical component in life support systems or any FDA Class 3 medical devices or medical devices with a same or similar classification in a foreign jurisdiction or any devices intended for implantation in the human body. Should Buyer purchase or use ON Semiconductor products for any such unintended or unauthorized application, Buyer shall indemnify and hold ON Semiconductor and its officers, employees, subsidiaries, affiliates, and distributors harmless against all claims, costs, damages, and expenses, and reasonable attorney fees arising out of, directly or indirectly, any claim of personal injury or death associated with such unintended or unauthorized use, even if such claim alleges that ON Semiconductor was negligent regarding the design or manufacture of the part. ON Semiconductor is an Equal Opportunity/Affirmative Action Employer. This literature is subject to all applicable copyright laws and is not for resale in any manner.

PUBLICATION ORDERING INFORMATION

LITERATURE FULFILLMENT:

Literature Distribution Center for ON Semiconductor
19521 E. 32nd Pkwy, Aurora, Colorado 80011 USA
Phone: 303-675-2175 or 800-344-3860 Toll Free USA/Canada
Fax: 303-675-2176 or 800-344-3867 Toll Free USA/Canada
Email: orderlit@onsemi.com

N. American Technical Support: 800-282-9855 Toll Free
USA/Canada
Europe, Middle East and Africa Technical Support:
Phone: 421 33 790 2910

ON Semiconductor Website: www.onsemi.com

Order Literature: <http://www.onsemi.com/orderlit>

For additional information, please contact your local Sales Representative