

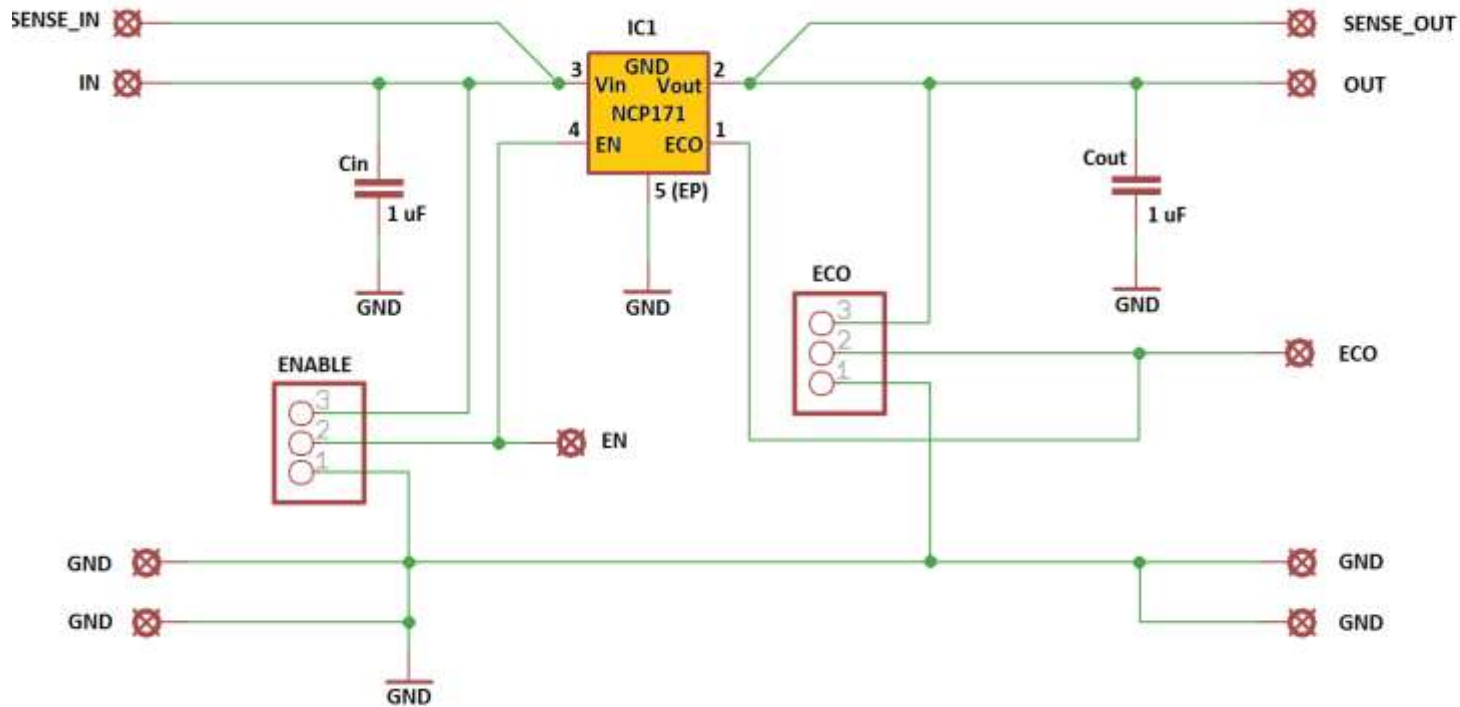

ON Semiconductor

Schematic for the NCP171AMX100080TCG LDO Demoboard



Programming I/F

