

# ON Semiconductor

## Is Now

# onsemi™

To learn more about onsemi™, please visit our website at  
[www.onsemi.com](http://www.onsemi.com)

---

**onsemi** and **onsemi** and other names, marks, and brands are registered and/or common law trademarks of Semiconductor Components Industries, LLC dba "**onsemi**" or its affiliates and/or subsidiaries in the United States and/or other countries. **onsemi** owns the rights to a number of patents, trademarks, copyrights, trade secrets, and other intellectual property. A listing of **onsemi** product/patent coverage may be accessed at [www.onsemi.com/site/pdf/Patent-Marking.pdf](http://www.onsemi.com/site/pdf/Patent-Marking.pdf). **onsemi** reserves the right to make changes at any time to any products or information herein, without notice. The information herein is provided "as-is" and **onsemi** makes no warranty, representation or guarantee regarding the accuracy of the information, product features, availability, functionality, or suitability of its products for any particular purpose, nor does **onsemi** assume any liability arising out of the application or use of any product or circuit, and specifically disclaims any and all liability, including without limitation special, consequential or incidental damages. Buyer is responsible for its products and applications using **onsemi** products, including compliance with all laws, regulations and safety requirements or standards, regardless of any support or applications information provided by **onsemi**. "Typical" parameters which may be provided in **onsemi** data sheets and/or specifications can and do vary in different applications and actual performance may vary over time. All operating parameters, including "Typicals" must be validated for each customer application by customer's technical experts. **onsemi** does not convey any license under any of its intellectual property rights nor the rights of others. **onsemi** products are not designed, intended, or authorized for use as a critical component in life support systems or any FDA Class 3 medical devices or medical devices with a same or similar classification in a foreign jurisdiction or any devices intended for implantation in the human body. Should Buyer purchase or use **onsemi** products for any such unintended or unauthorized application, Buyer shall indemnify and hold **onsemi** and its officers, employees, subsidiaries, affiliates, and distributors harmless against all claims, costs, damages, and expenses, and reasonable attorney fees arising out of, directly or indirectly, any claim of personal injury or death associated with such unintended or unauthorized use, even if such claim alleges that **onsemi** was negligent regarding the design or manufacture of the part. **onsemi** is an Equal Opportunity/Affirmative Action Employer. This literature is subject to all applicable copyright laws and is not for resale in any manner. Other names and brands may be claimed as the property of others.

**User Guide for**  
**FEBFAN48610\_M00LPOLA**  
**Evaluation Board**

**Synchronous Boost Regulator with**  
**Pass-Through Mode**

**Featured Fairchild Product:**  
**FAN48610**

*Direct questions or comments  
about this evaluation board to:  
“Worldwide Direct Support”*

[Fairchild Semiconductor.com](http://Fairchild Semiconductor.com)

## Table of Contents

1. Description.....	3
1.1. Features .....	3
1.2. Quick Start Connection Guide .....	4
2. Bill of Materials .....	4
3. Evaluation Board Special Features .....	5
3.1. On-Board Load Current Control .....	5
3.2. Input / Output Capacitance.....	5
3.3. ENABLE Header (J4) .....	5
3.4. Signal Monitoring .....	5
4. Printed Circuit Board .....	6
5. Schematic.....	9
6. Revision History .....	10

This user guide supports the evaluation kit for the FAN48610. It should be used in conjunction with the FAN48610 datasheet as well as Fairchild's application notes and technical support team. Please visit Fairchild's website at [www.fairchildsemi.com](http://www.fairchildsemi.com).

## 1. Description

The FAN48610 evaluation board is a compact circuit including Fairchild's FAN48610 synchronous boost regulator with Pass-Through Mode in a 9-bump Wafer-Level Chip-Scale Package (WLCSP). Small input/output capacitors and a 470 nH inductor ensure smooth output regulation.

The board also features an on-board active load circuit and footprints to accommodate additional input/output capacitors. The evaluation board provides probe access points to all key circuit nodes so that electrical characteristics can be measured.

### 1.1. Features

- Input Voltage Range: 2.35 V to 5.50 V
- Output Voltages Range: 3.0 V to 5.0 V
- $I_{OUT} \geq 1 \text{ A}$  at  $V_{OUT} = 5.0 \text{ V}$ ,  $V_{IN} \geq 2.5 \text{ V}$
- $I_{OUT} \geq 1.5 \text{ A}$  at  $V_{OUT} = 5.0 \text{ V}$ ,  $V_{IN} \geq 3.0 \text{ V}$
- Up to 94% Efficient
- Automatic Pass-Through Operation when  $V_{IN} > V_{OUT}$
- Internal Synchronous Rectification
- Soft-Start with True Load Disconnect
- Short-Circuit Protection
- 9-Bump, 1.215 mm x 1.215 mm, 0.4 mm Pitch WLCSP
- Three External Components: 2016 0.47  $\mu\text{H}$  Inductor, 0603 Case Size Input / Output Capacitors

## 1.2. Quick Start Connection Guide

1. Connect VIN to input power supply (2.35V -5.50 V) as shown in Figure 1.
2. Set EN header (J4) at the '1' position with a jumper.
3. Connect the external load between VOUT and PGND.
4. Kelvin connected input and output voltage-sense points (VIN\_S, VOUT\_S) are provided. Measure relative to AGND.

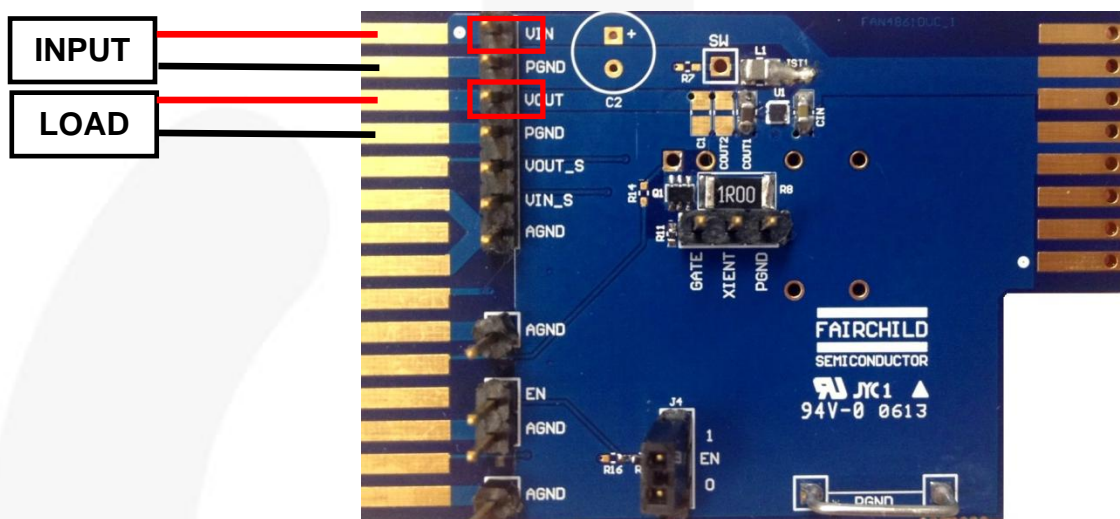

Figure 1. Evaluation Board Connection Diagram Evaluation Board Specifications

## 2. Bill of Materials

Reference	Qty.	Description	Manufacturer
U1	1	IC, FAN48610 (WLCSP 9)	Fairchild Semiconductor
L1	1	470 nH, 3.2 A, 40 mΩ, 20%, 2016	TOKO DFE201612C-R47M
Q1	1	NMOS, 30 V, 2 A, SC70-6	Fairchild Semiconductor FDG315N
C <sub>IN</sub>	1	10 µF, 6.3 V, 10%, X5R, 0603	TDK C1608X5R0J106K080AB
C <sub>OUT1</sub>	1	22 µF, 6.3 V, 20%, X5R, 0603	TDK C1608X5R0J226M080AC
R2	1	20 kΩ, 5%, 0402	
R8	1	1.0 Ω, 1%, 2010	
R11	1	1.0 kΩ, 5%, 0402	
R7, R14, R15, R16	4	No Load 0402	
C <sub>OUT2</sub> , C1	2	No Load 0603	
C2	1	No Load ALEL	

### 3. Evaluation Board Special Features

#### 3.1. On-Board Load Current Control

Most electronic loads cannot generate the kind of high-speed load transients that occur in modern applications.

To facilitate these high-speed transient edges (~100 ns), the FAN48610 evaluation board includes a MOSFET (Q1) and a 1 Ω current-sense resistor (R8) connected to VOUT (see Figure 2). This circuit is not rated for the dissipation associated with DC loads. 10% maximum duty cycle is recommended.

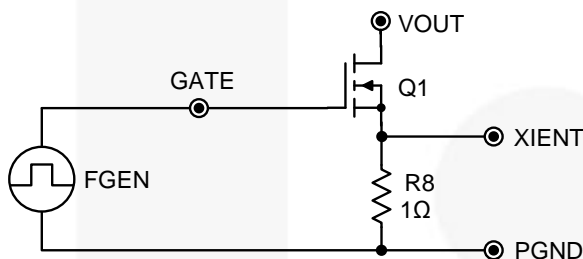

Figure 2. On-Board Load Current Control

The NFET is wired as a source follower to provide simple amplitude and rise/fall time control. It can be driven by a pulse generator. The load current step depends on the applied GATE voltage and  $I_{d(V_{GS})}$  characteristic of the NFET at ambient operating temperature. To simplify the load current setup, a precision 1 Ω sense resistor allows the load current to be read at a 1 mV/1 mA rate on the XIENT pin.

Table 1. Typical  $V_{GATE}$  to Load Dependence

Load (mA)	$V_{GATE}$ (V)
0	1.80
50	1.85
200	2.00

#### 3.2. Input / Output Capacitance

The FAN48610 evaluation board includes empty locations for the addition of input or output capacitance.

The C2 location should be used to provide a suitable local charge reservoir when inductance is introduced by long cables from the DC source.

#### 3.3. ENABLE Header (J4)

The ENABLE header is set to '1' position by default. To disable the FAN48610, move the EN jumper to the '0' position.

#### 3.4. Signal Monitoring

VIN\_S, VOUT\_S, and EN signals can be monitored with an oscilloscope probe at headers, as shown in Figure 1. Measure relative to AGND.

For best output ripple measurements, do not use VOUT\_S; instead monitor directly across the output capacitor with an oscilloscope probe.

## 4. Printed Circuit Board

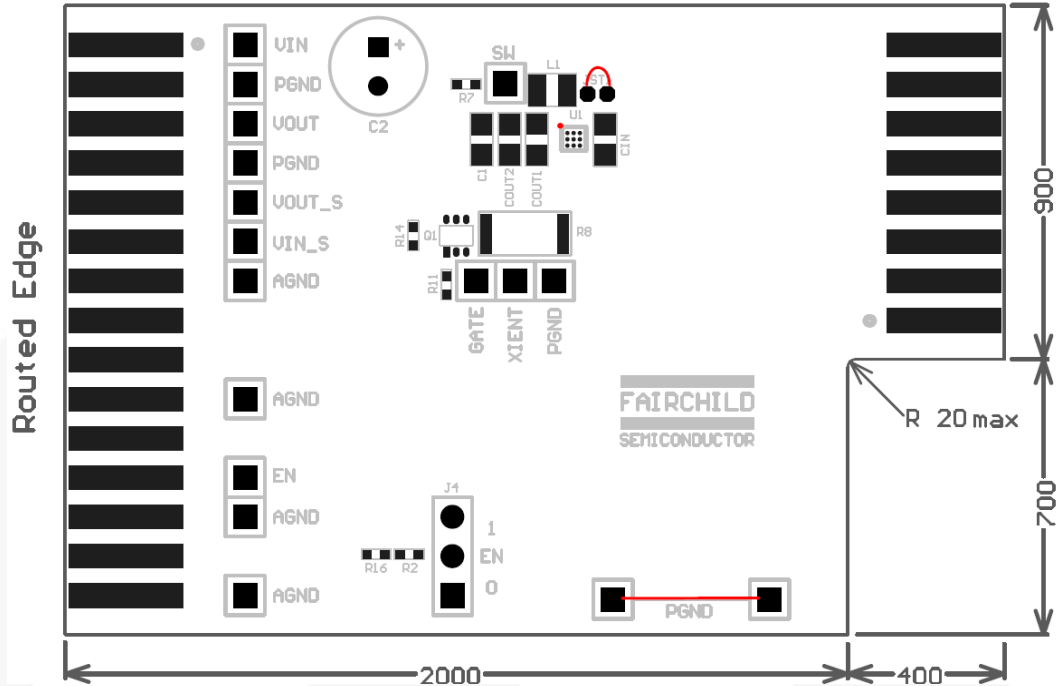

Figure 3. Top-Side Silk Screen

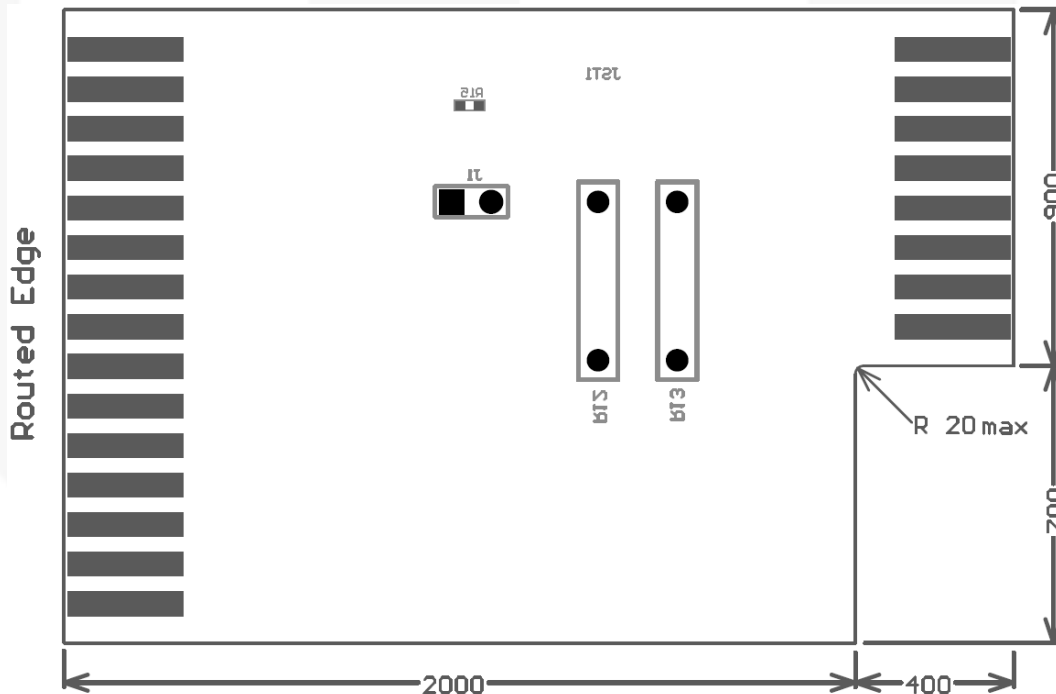

Figure 4. Bottom-Side Silk Screen

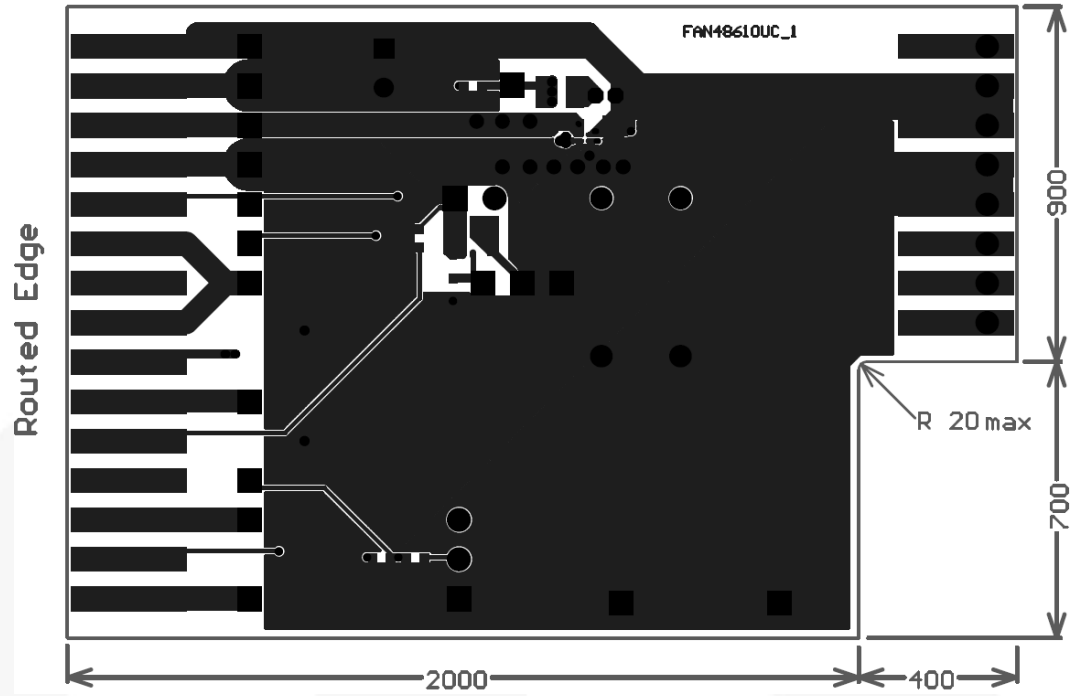

Figure 5. Top Layer

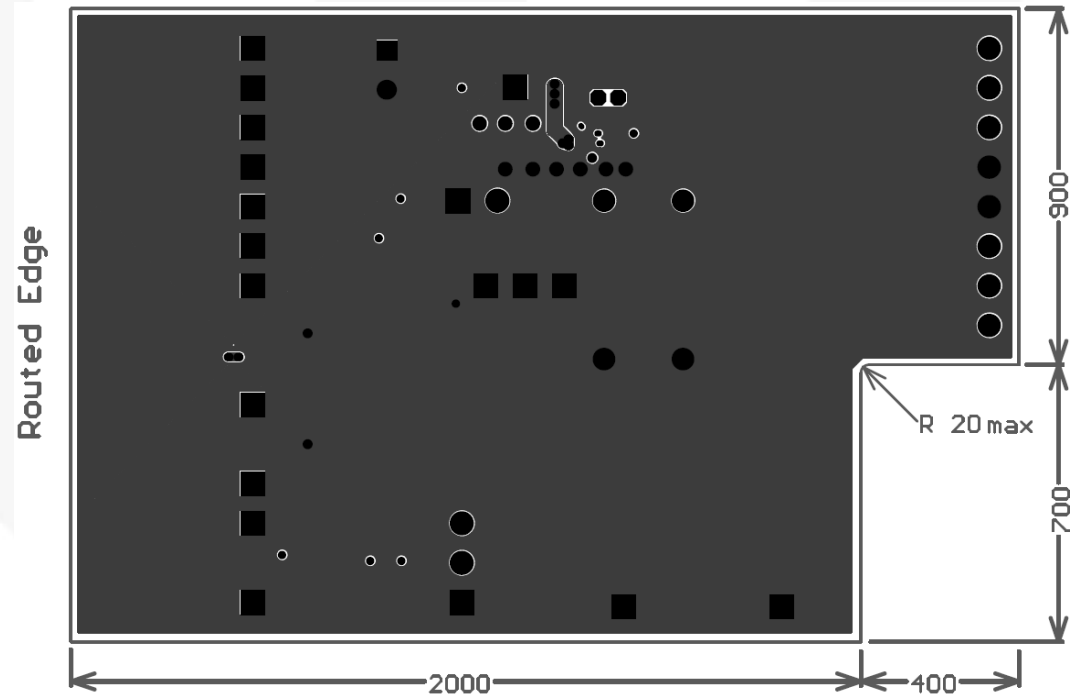

Figure 6. Mid-Layer 1



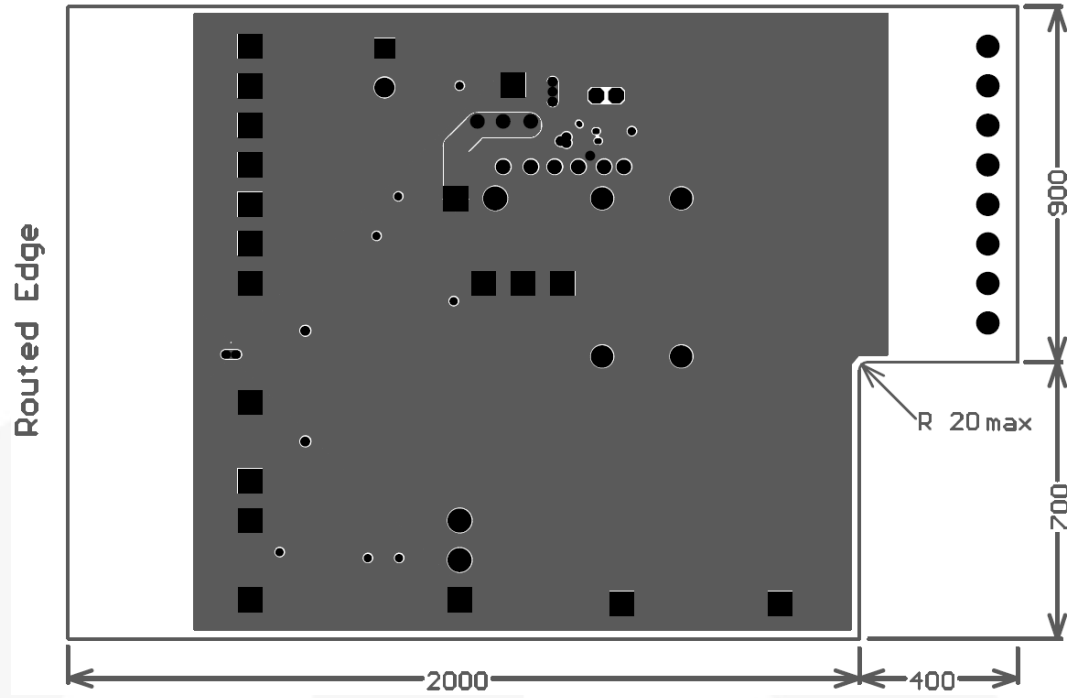

Figure 7. Mid-Layer 2

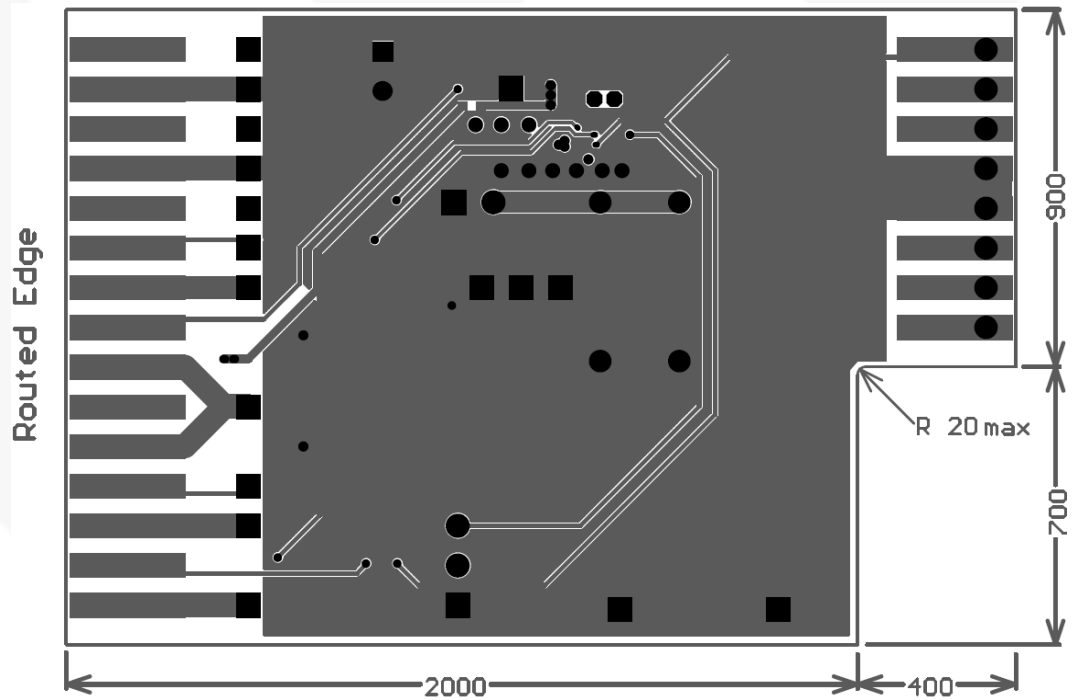

Figure 8. Bottom Layers



## 6. Revision History

Rev.	Date	Description
1.0.0	November 2013	Initial Release

---

### WARNING AND DISCLAIMER

Replace components on the Evaluation Board only with those parts shown on the parts list (or Bill of Materials) in the Users' Guide. Contact an authorized Fairchild representative with any questions.

This board is intended to be used by certified professionals, in a lab environment, following proper safety procedures. Use at your own risk. The Evaluation board (or kit) is for demonstration purposes only and neither the Board nor this User's Guide constitute a sales contract or create any kind of warranty, whether express or implied, as to the applications or products involved. Fairchild warrants that its products meet Fairchild's published specifications, but does not guarantee that its products work in any specific application. Fairchild reserves the right to make changes without notice to any products described herein to improve reliability, function, or design. Either the applicable sales contract signed by Fairchild and Buyer or, if no contract exists, Fairchild's standard Terms and Conditions on the back of Fairchild invoices, govern the terms of sale of the products described herein.

#### DISCLAIMER

FAIRCHILD SEMICONDUCTOR RESERVES THE RIGHT TO MAKE CHANGES WITHOUT FURTHER NOTICE TO ANY PRODUCTS HEREIN TO IMPROVE RELIABILITY, FUNCTION, OR DESIGN. FAIRCHILD DOES NOT ASSUME ANY LIABILITY ARISING OUT OF THE APPLICATION OR USE OF ANY PRODUCT OR CIRCUIT DESCRIBED HEREIN; NEITHER DOES IT CONVEY ANY LICENSE UNDER ITS PATENT RIGHTS, NOR THE RIGHTS OF OTHERS.

#### LIFE SUPPORT POLICY

FAIRCHILD'S PRODUCTS ARE NOT AUTHORIZED FOR USE AS CRITICAL COMPONENTS IN LIFE SUPPORT DEVICES OR SYSTEMS WITHOUT THE EXPRESS WRITTEN APPROVAL OF THE PRESIDENT OF FAIRCHILD SEMICONDUCTOR CORPORATION.

As used herein:

- |   |   |
|---|---|
| <p>1. Life support devices or systems are devices or systems which, (a) are intended for surgical implant into the body, or (b) support or sustain life, or (c) whose failure to perform when properly used in accordance with instructions for use provided in the labeling, can be reasonably expected to result in significant injury to the user.</p> | <p>2. A critical component is any component of a life support device or system whose failure to perform can be reasonably expected to cause the failure of the life support device or system, or to affect its safety or effectiveness.</p> |
|---|---|

---

### ANTI-COUNTERFEITING POLICY

Fairchild Semiconductor Corporation's Anti-Counterfeiting Policy. Fairchild's Anti-Counterfeiting Policy is also stated on our external website, [www.fairchildsemi.com](http://www.fairchildsemi.com), under Sales Support.

Counterfeiting of semiconductor parts is a growing problem in the industry. All manufacturers of semiconductor products are experiencing counterfeiting of their parts. Customers who inadvertently purchase counterfeit parts experience many problems such as loss of brand reputation, substandard performance, failed applications, and increased cost of production and manufacturing delays. Fairchild is taking strong measures to protect ourselves and our customers from the proliferation of counterfeit parts. Fairchild strongly encourages customers to purchase Fairchild parts either directly from Fairchild or from Authorized Fairchild Distributors who are listed by country on our web page cited above. Products customers buy either from Fairchild directly or from Authorized Fairchild Distributors are genuine parts, have full traceability, meet Fairchild's quality standards for handling and storage and provide access to Fairchild's full range of up-to-date technical and product information. Fairchild and our Authorized Distributors will stand behind all warranties and will appropriately address any warranty issues that may arise. Fairchild will not provide any warranty coverage or other assistance for parts bought from Unauthorized Sources. Fairchild is committed to combat this global problem and encourage our customers to do their part in stopping this practice by buying direct or from authorized distributors.

---

### EXPORT COMPLIANCE STATEMENT

These commodities, technology, or software were exported from the United States in accordance with the Export Administration Regulations for the ultimate destination listed on the commercial invoice. Diversion contrary to U.S. law is prohibited.

U.S. origin products and products made with U.S. origin technology are subject to U.S. Re-export laws. In the event of re-export, the user will be responsible to ensure the appropriate U.S. export regulations are followed.