

AP0202ATSL00XUGAH3-GEVB

AP0202AT Evaluation Board User's Manual



ON Semiconductor®

www.onsemi.com

EVAL BOARD USER'S MANUAL

Evaluation Board Overview

The evaluation boards are designed to demonstrate the features of image sensors products from ON Semiconductor. This headboard is intended to plug directly into the Demo 3 system. Test points and jumpers on the board provide access to the clock, I/Os, and other miscellaneous signals.

Features

- Clock Input
 - ◆ Default – 27 MHz Crystal Oscillator
 - ◆ Optional Demo 3 Controlled MClk
- Two Wire Serial Interface
 - ◆ Selectable Base Address
- Parallel Interface
- HiSPi (High Speed Serial Pixel) Interface
- ROHS Compliant



Figure 1. AP0202AT Evaluation Board

Block Diagram

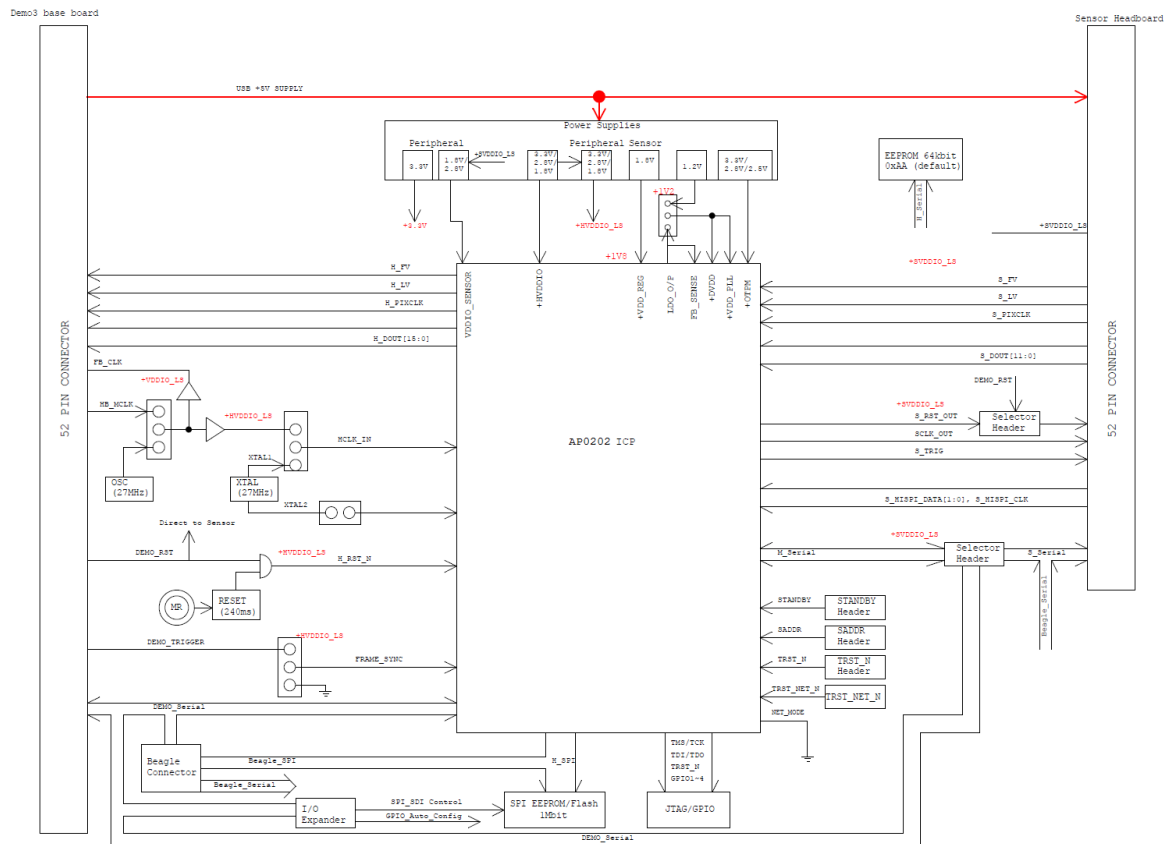

Figure 2. Block Diagram of AP0202ATSL00XUGAH3-GEVB

AP0202ATSL00XUGAH3-GEVB

Top View

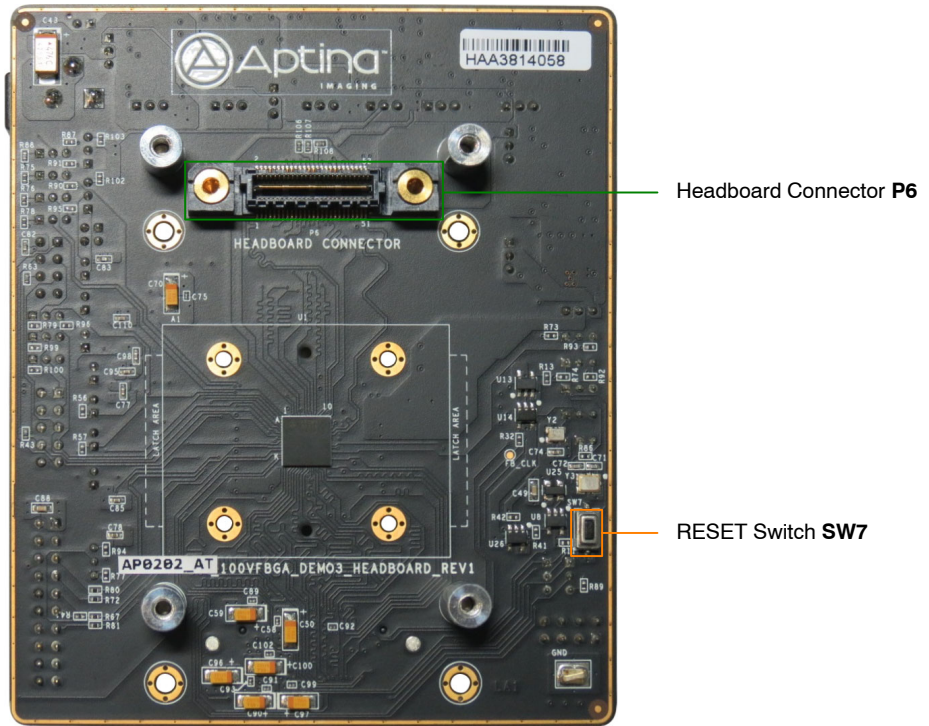

Figure 3. Top View of the Board – Default Jumpers

Bottom View

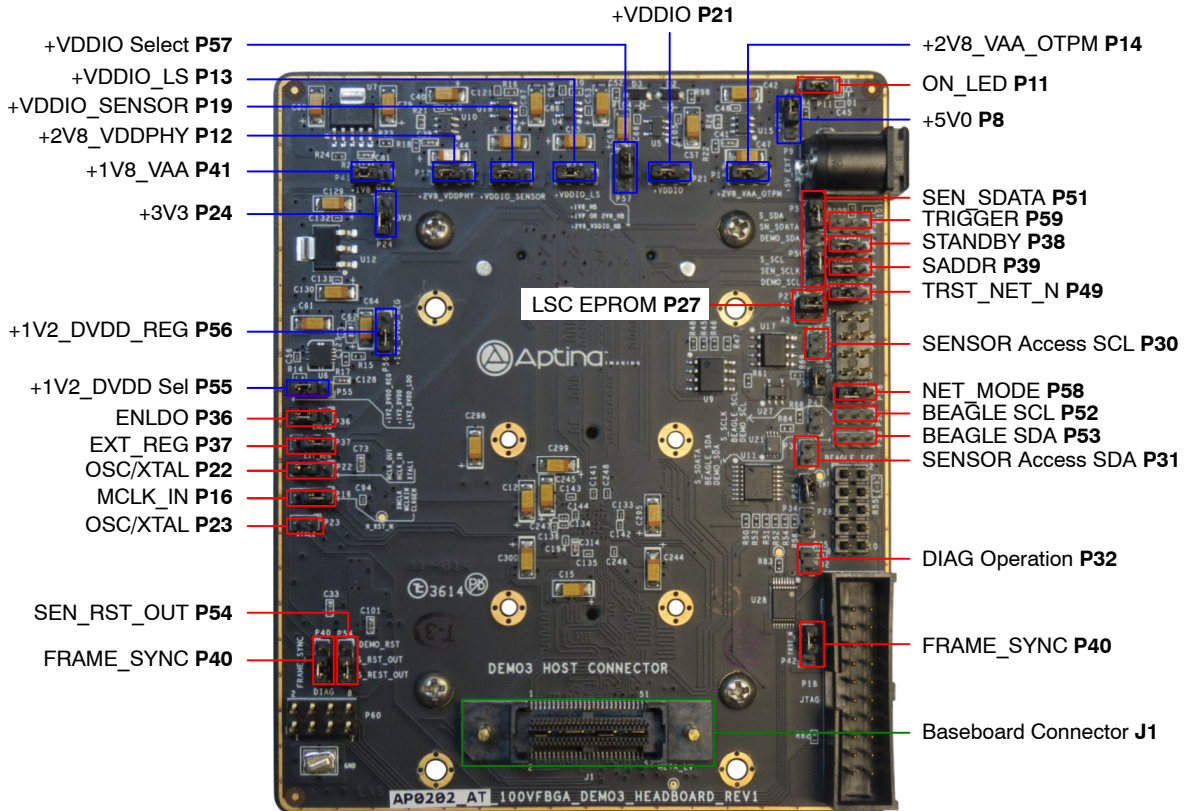

Figure 4. Bottom View of the Board – Connectors

Jumper Pin Locations

The jumpers on headboards start with Pin 1 on the leftmost side of the pin. Grouped jumpers increase in pin size with each jumper added.



Figure 5. Pin Locations for a Single Jumper. Pin 1 is Located at the Leftmost Side and Increases as it Moves to the Right

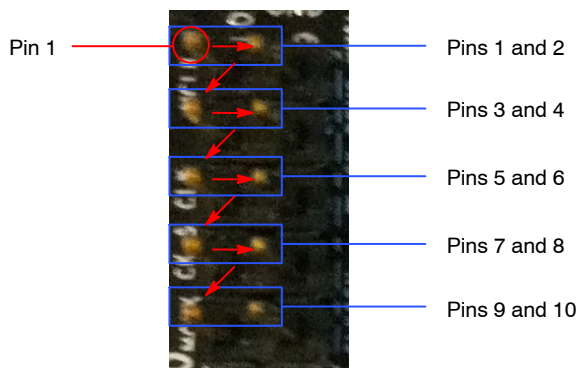

Figure 6. Pin Locations and Assignments of Grouped Jumpers. Pin 1 is Located at the Top-Left Corner and Increases in a Zigzag Fashion Shown in the Picture

Jumper/Header Functions & Default Positions

Table 1. JUMPERS AND HEADERS

Jumper/Header No.	Jumper/Header Name	Pins	Description
P5, P47	EEPROM Mode	P5 Closed, P47 Open (Default)	Set to Host Mode during Power On
		P5 Open, P47 Open	Set to Flash Mode during Power On
		P47 Closed	Set to Auto-Config Mode during Power On
P8	+5V0	2-3 (Default)	Using On-Board +5V0 Power Supply
		1-2	Using +5V0 Supply from External Power Adapter
P11	ON_LED	1-2 (Default)	Connects to On-Board to Indicate "Power On"
P12	+2V8_VDDPHY	2-3 (Default)	Using On-Board +2V8_VDDPHY_ADJ Power Supply
		1-2	Using +2V8_VDDIO_HB Power Supply from Demo 3 Baseboard
P13	+VDDIO_LS	2-3 (Default)	Using On-Board Power Supply
		1-2	Using +1V8_HB Power Supply from Demo 3 Baseboard
P14	+2V8_VAA_OTPM	2-3 (Default)	Using On-Board +2V8_VAA_OTPM_ADJ Power Supply
		1-2	Using +2V8_VAA_HB Power Supply from Demo 3 Baseboard
P16	MCLK_IN	1-2 (Default)	Connects to On-Board Oscillator
		2-3	Connects to XMCLK
P19	+VDDIO_SENSOR	2-3 (Default)	Using On-Board Power Supply
		1-2	Using +1V8_HB Power Supply from Demo 3 Baseboard

AP0202ATSL00XUGAH3-GEVB

Table 1. JUMPERS AND HEADERS (continued)

Jumper/Header No.	Jumper/Header Name	Pins	Description
P21	+VDDIO	2-3 (Default)	Using On-Board Power Supply
		1-2	Using +1V8_HB or +2V8_HB Power Supply from Demo 3 Baseboard
P22, P23	OSC/XTAL Select	P22 2-3, P23 Open (Default)	Oscillator/Demo Clock Selected
		P22 1-2, P23 Closed	On-Board Crystal Selected
P24	+3V3	2-3 (Default)	Using On-Board Power Supply
		1-2	Using +3V3_HB Power Supply from Demo 3 Baseboard
P25, P34	I/O Expander Address	P25 Closed, P34 Open (Default)	I/O Expander Address Set to 0x48
		P25 Open, P34 Open	I/O Expander Address Set to 0x4C
		P25 Open, P34 Closed	I/O Expander Address Set to 0x44
		P25 Closed, P34 Closed	I/O Expander Address Set to 0x40
P27	LSC EEPROM	1-2 Closed, 3-4 Open (Default)	EEPROM Address Set to 0xA8
		1-2 Open, 3-4 Open	EEPROM Address Set to 0xAC
		1-2 Open, 3-4 Closed	EEPROM Address Set to 0xA4
		1-2 Closed, 3-4 Closed	EEPROM Address Set to 0xA0
P30	Sensor Access SCL	Open (Default)	Beagle Serial No Access to Demo 3 & Sensor
		1-2	Beagle Serial Access to Demo 3 & Sensor
P31	Sensor Access SDA	Open (Default)	Beagle Serial No Access to Demo 3 & Sensor
		1-2	Beagle Serial Access to Demo 3 & Sensor
P32	Diag Operation	Open (Default)	Disable Diag Operation
		1-2	Enable Diag Operation
P36	ENLDO	2-3 (Default)	Internal Regulator Not Enabled
		1-2	Regulator Enable
P37	EXT_REG	1-2 (Default)	Select External Regulator
		2-3	Select Internal Regulator
P38	STANDBY	2-3 (Default)	Active Mode
		1-2	Standby Mode
P39	SADDR	2-3 (Default)	I ² C Address Set to 0x90
		1-2	I ² C Address Set to 0xBA
P40	FRAME_SYNC	2-3 (Default)	GND
		1-2	Connect to Demo 3 Trigger
P41	+1V8_VAA	2-3 (Default)	Using On-Board +1V8_VAA Power Supply
		1-2	Using +1V8_HB Power Supply from Demo 3 Baseboard
P42	TRST_N	2-3 (Default)	Normal Mode
		1-2	Test Mode for Image System Processor
P49	TRST_NET_N	2-3 (Default)	Normal Mode
		1-2	Test Mode for Image Agent Processor
P50	SEN_SCLK	2-3 (Default)	AP0202 Serial Control
		1-2	Demo 3 Serial Control

AP0202ATSL00XUGAH3-GEVB

Table 1. JUMPERS AND HEADERS (continued)

Jumper/Header No.	Jumper/Header Name	Pins	Description
P51	SEN_SDATA	Open (Default)	AP0202 Serial Control
		1-2	Demo 3 Serial Control
P52	BEAGLE_SCL	1-2	Demo 3 Accessed
		2-3	Sensor Accessed
P53	BEAGLE_SDA	1-2	Demo 3 Accessed
		2-3	Sensor Accessed
P54	SEN_RST_OUT	2-3 (Default)	AP0202 Reset
		1-2	Demo 3 Reset
P55	+1V2_DVDD Selection	2-3 (Default)	Using On-Board Regulator +1V2 Power Supply
		1-2	Using +1V2 Internal Power Supply
P56	+1V2_DVDD_REG	2-3 (Default)	Using On-Board +1V2_DVDD_ADJ Power Supply
		1-2	Using +1V2_HB Power Supply from Demo 3 Baseboard
P57	+VDDIO Selection	1-2 (Default)	Using +1V8_HB Supply for +VDDIO
		2-3	Using +2V8_HB Supply for +VDDIO
P58	NET_MODE	2-3 (Default)	I ² C to Image Co-Processor
		1-2	I ² C to Agent Co-Processor
P59	TRIGGER	2-3	Connect to GND
		1-2	Connect to +VDDIO
		Open (Default)	Control from Demo 3 Baseboard
SW7	RESET	N/A	When Pushed, 240 ms Reset Signal will be Sent to AP0202

Interfacing to ON Semiconductor Demo 3 Baseboard

The ON Semiconductor Demo 3 baseboard has a similar 52-pin connector which mates with J1 of the headboard.

The four mounting holes secure the baseboard and the headboard with spacers and screws.

onsemi, **Onsemi**, and other names, marks, and brands are registered and/or common law trademarks of Semiconductor Components Industries, LLC dba "**onsemi**" or its affiliates and/or subsidiaries in the United States and/or other countries. **onsemi** owns the rights to a number of patents, trademarks, copyrights, trade secrets, and other intellectual property. A listing of **onsemi**'s product/patent coverage may be accessed at www.onsemi.com/site/pdf/Patent-Marking.pdf. **onsemi** is an Equal Opportunity/Affirmative Action Employer. This literature is subject to all applicable copyright laws and is not for resale in any manner.

The evaluation board/kit (research and development board/kit) (hereinafter the "board") is not a finished product and is not available for sale to consumers. The board is only intended for research, development, demonstration and evaluation purposes and will only be used in laboratory/development areas by persons with an engineering/technical training and familiar with the risks associated with handling electrical/mechanical components, systems and subsystems. This person assumes full responsibility/liability for proper and safe handling. Any other use, resale or redistribution for any other purpose is strictly prohibited.

THE BOARD IS PROVIDED BY ONSEMI TO YOU "AS IS" AND WITHOUT ANY REPRESENTATIONS OR WARRANTIES WHATSOEVER. WITHOUT LIMITING THE FOREGOING, ONSEMI (AND ITS LICENSORS/SUPPLIERS) HEREBY DISCLAIMS ANY AND ALL REPRESENTATIONS AND WARRANTIES IN RELATION TO THE BOARD, ANY MODIFICATIONS, OR THIS AGREEMENT, WHETHER EXPRESS, IMPLIED, STATUTORY OR OTHERWISE, INCLUDING WITHOUT LIMITATION ANY AND ALL REPRESENTATIONS AND WARRANTIES OF MERCHANTABILITY, FITNESS FOR A PARTICULAR PURPOSE, TITLE, NON-INFRINGEMENT, AND THOSE ARISING FROM A COURSE OF DEALING, TRADE USAGE, TRADE CUSTOM OR TRADE PRACTICE.

onsemi reserves the right to make changes without further notice to any board.

You are responsible for determining whether the board will be suitable for your intended use or application or will achieve your intended results. Prior to using or distributing any systems that have been evaluated, designed or tested using the board, you agree to test and validate your design to confirm the functionality for your application. Any technical, applications or design information or advice, quality characterization, reliability data or other services provided by **onsemi** shall not constitute any representation or warranty by **onsemi**, and no additional obligations or liabilities shall arise from **onsemi** having provided such information or services.

onsemi products including the boards are not designed, intended, or authorized for use in life support systems, or any FDA Class 3 medical devices or medical devices with a similar or equivalent classification in a foreign jurisdiction, or any devices intended for implantation in the human body. You agree to indemnify, defend and hold harmless **onsemi**, its directors, officers, employees, representatives, agents, subsidiaries, affiliates, distributors, and assigns, against any and all liabilities, losses, costs, damages, judgments, and expenses, arising out of any claim, demand, investigation, lawsuit, regulatory action or cause of action arising out of or associated with any unauthorized use, even if such claim alleges that **onsemi** was negligent regarding the design or manufacture of any products and/or the board.

This evaluation board/kit does not fall within the scope of the European Union directives regarding electromagnetic compatibility, restricted substances (RoHS), recycling (WEEE), FCC, CE or UL, and may not meet the technical requirements of these or other related directives.

FCC WARNING – This evaluation board/kit is intended for use for engineering development, demonstration, or evaluation purposes only and is not considered by **onsemi** to be a finished end product fit for general consumer use. It may generate, use, or radiate radio frequency energy and has not been tested for compliance with the limits of computing devices pursuant to part 15 of FCC rules, which are designed to provide reasonable protection against radio frequency interference. Operation of this equipment may cause interference with radio communications, in which case the user shall be responsible, at its expense, to take whatever measures may be required to correct this interference.

onsemi does not convey any license under its patent rights nor the rights of others.

LIMITATIONS OF LIABILITY: **onsemi** shall not be liable for any special, consequential, incidental, indirect or punitive damages, including, but not limited to the costs of requalification, delay, loss of profits or goodwill, arising out of or in connection with the board, even if **onsemi** is advised of the possibility of such damages. In no event shall **onsemi**'s aggregate liability from any obligation arising out of or in connection with the board, under any theory of liability, exceed the purchase price paid for the board, if any.

The board is provided to you subject to the license and other terms per **onsemi**'s standard terms and conditions of sale. For more information and documentation, please visit www.onsemi.com.

PUBLICATION ORDERING INFORMATION

LITERATURE FULFILLMENT:

Email Requests to: orderlit@onsemi.com

onsemi Website: www.onsemi.com

TECHNICAL SUPPORT

North American Technical Support:

Voice Mail: 1 800-282-9855 Toll Free USA/Canada

Phone: 011 421 33 790 2910

Europe, Middle East and Africa Technical Support:

Phone: 00421 33 790 2910

For additional information, please contact your local Sales Representative