

# NCP1339GEVB

*Product Preview*

## **A 45 W Adaptor with NCP1339 Quasi-Resonant Controller Evaluation Board User's Manual**



**ON Semiconductor®**

<http://onsemi.com>

### **EVAL BOARD USER'S MANUAL**

#### **Introduction**

The NCP1339 is a highly integrated quasi-resonant flyback controller capable of controlling rugged and high-performance off-line power supplies as required by adapter applications. With an integrated active X-cap discharge feature and power savings mode, the NCP1339 can enable no-load power consumption below 10 mW for 65 W notebook adapters.

The quasi-resonant current-mode flyback stage features a proprietary valley-lockout circuitry, ensuring stable valley switching. This system works down to the 6<sup>th</sup> valley and toggles to a frequency foldback mode to eliminate switching losses. When the loop tends to force below 25 kHz frequencies, the NCP1339 skips cycles to contain the power delivery.

To help build rugged converters, the controller features several key protective features: an internal brown-out, a non-dissipative Over Power Protection for a constant

maximum output current regardless of the input voltage, a latching-off over voltage protection through a dedicated pin.

This application note focuses on the experimental results of a 45 W adaptor driven by the NCP1339.

**Table 1. EVALUATION BOARD SPECIFICATION**

<b>Parameter</b>	<b>Value</b>
Minimum input voltage	85 V rms
Maximum input voltage	265 V rms
Output voltage	19 V
Nominal output power	45 W

#### **Description of the Board**

The 45 W adapter has been designed using the method described in the application note AND9176/D and also Mathcad file.

This document contains information on a product under development. ON Semiconductor reserves the right to change or discontinue this product without notice.

# NCP1339GEVB

## BOARD SCHEMATIC

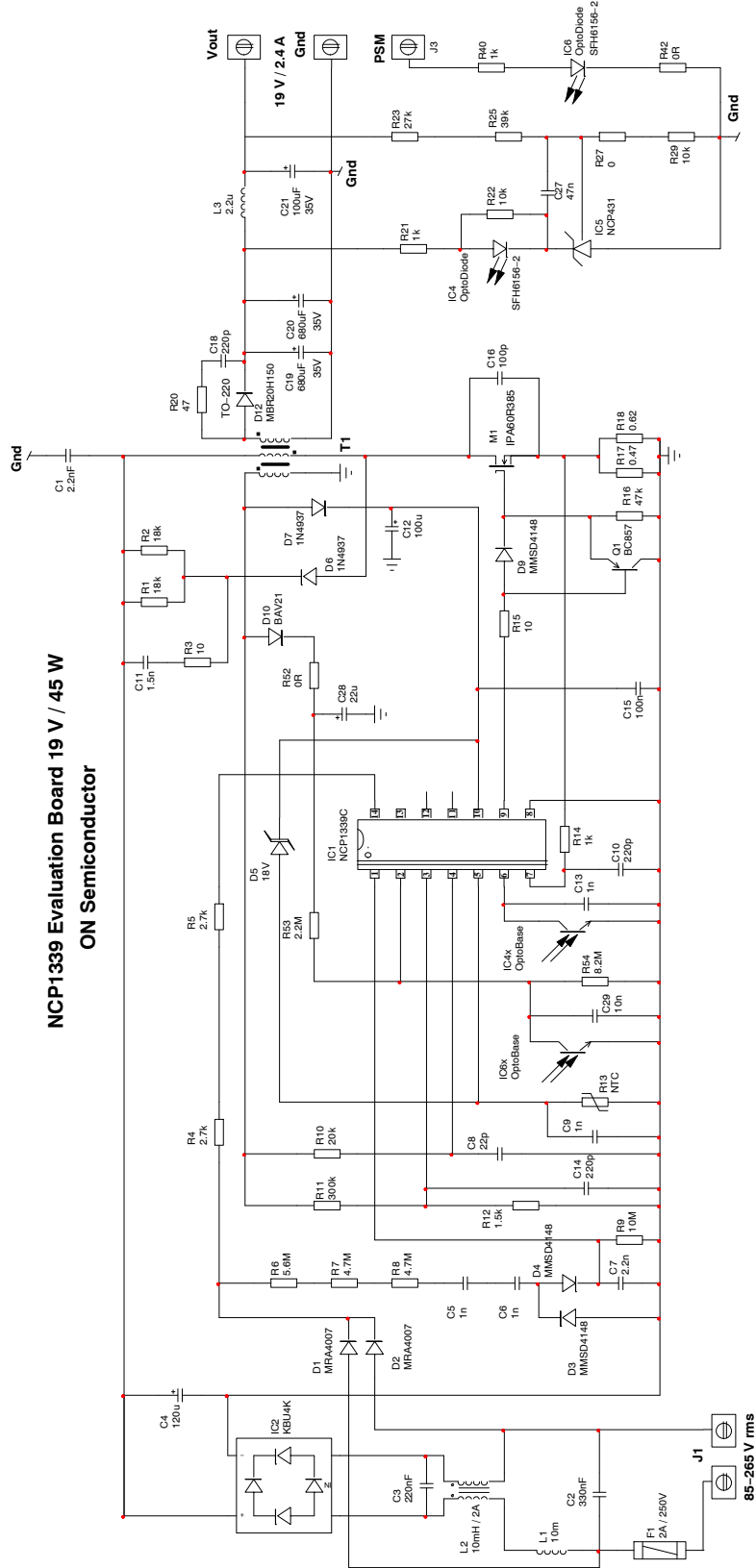

Figure 1. Evaluation Board Schematic

# NCP1339GEVB

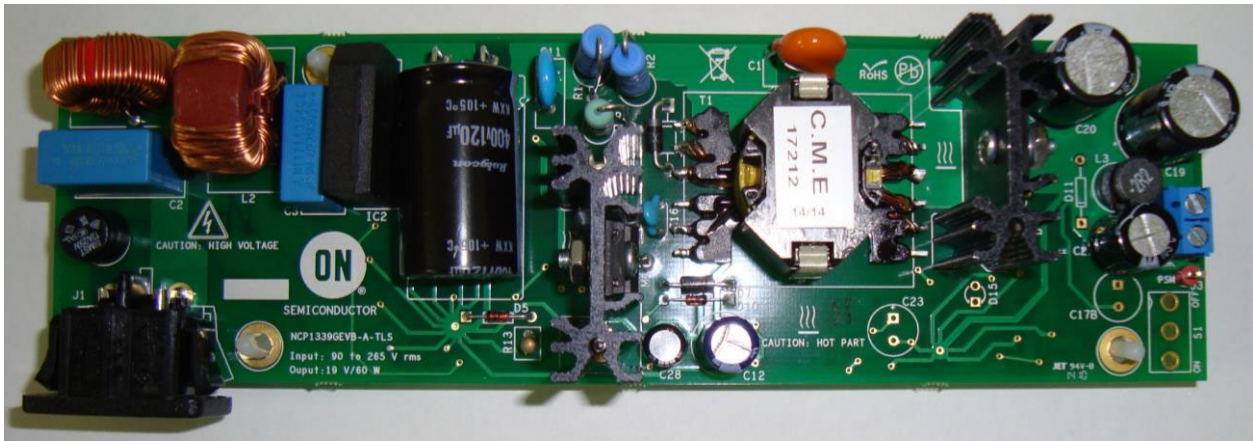

Figure 2. Evaluation Board Picture (Top View)

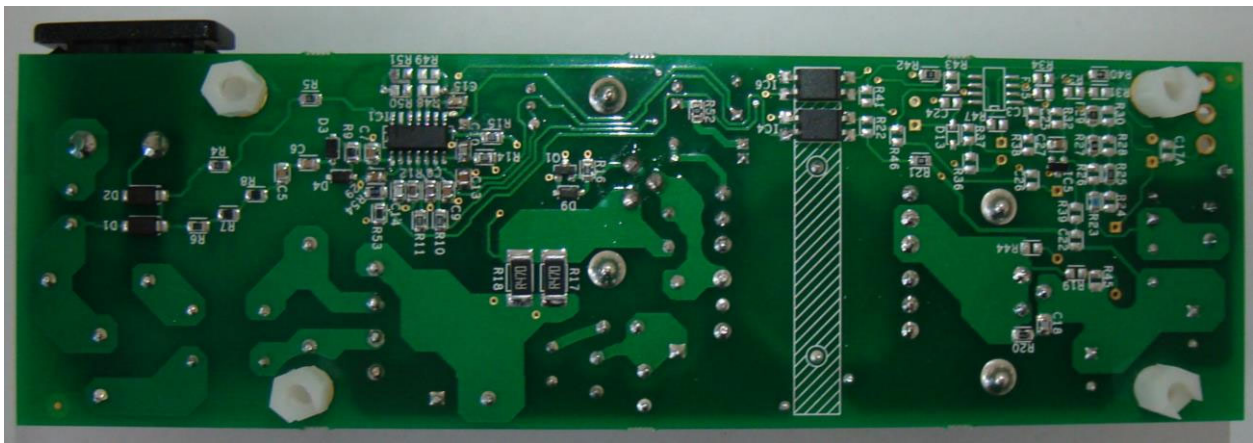

Figure 3. Evaluation Board Picture (Bottom View)

## Efficiency Results

All measurements have been done after a 30 min burn-out phase at full load and an additional 10 min at the load under consideration.

The input power was measured with the power meter 66202 from Chroma.

The output voltage and output current were measured using digital multimeter embedded on dc electronic load 66103 from Chroma.

Table 2. EFFICIENCY @ 115 V RMS AND 230 V RMS

Input voltage	Pout (%)	Pout (W)	Pin (W)	Efficiency (%)	
115 V rms	100	45.11	51.22	88.08	
	75	33.88	38.51	88.00	
	50	22.62	25.77	87.77	
	25	11.38	13.14	86.63	
	Average	-	-	-	87.62
	No load	-	-	42 m	-
230 V rms	100	45.13	50.87	88.71	
	75	33.89	38.41	88.22	
	50	22.61	25.93	87.19	
	25	11.39	13.43	84.80	
	Average	-	-	-	87.23
	No load	-	-	36 m	-

The average efficiency was calculated from the efficiency measurements at 25%, 50%, 75% and 100% of the nominal output power.

# NCP1339GEVB

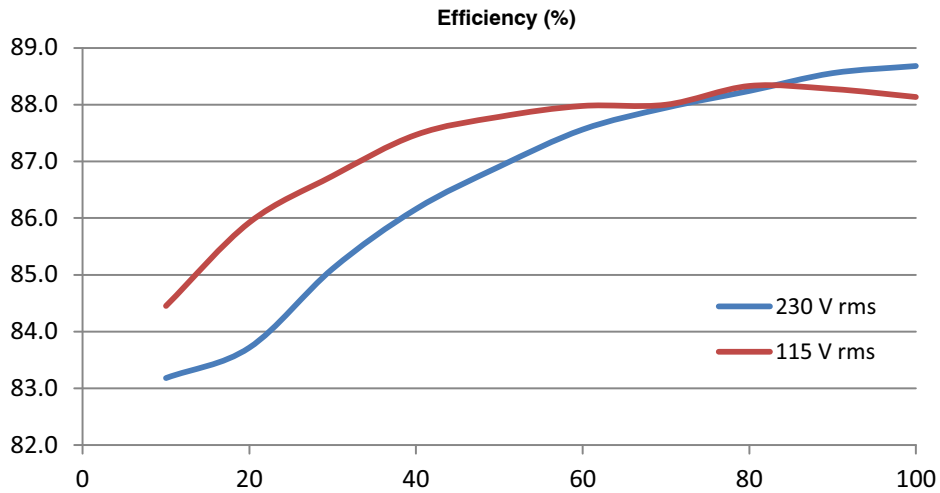

Figure 4. Efficiency (%) vs. Output Power (% of max) at 115 V rms and 230 V rms

## TYPICAL WAVEFORMS

### Valley Lockout

The valley lockout technique makes controller changes valley (from the 1<sup>st</sup> to the 6<sup>th</sup> valley) as the load decreases without any valley jumping. This allows extending the quasi-resonance (QR) operation range.

The following scope shoots show the operating valley as the load decreases for an input voltage of 115 Vrms.



Figure 5. QR (1<sup>st</sup> Valley) Operation @ 45 W / 115 V rms

# NCP1339GEVB

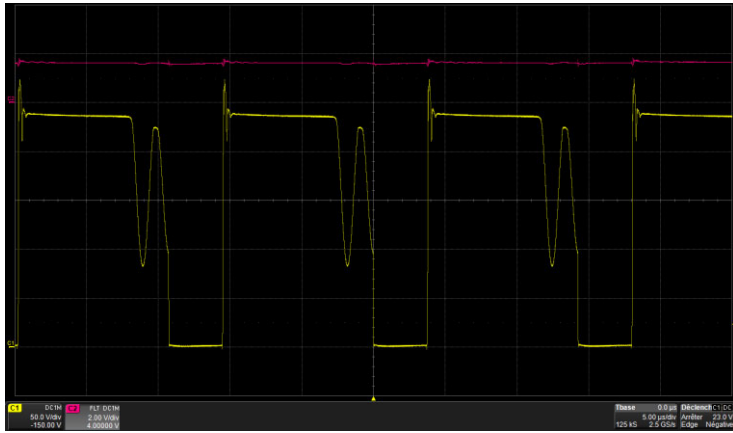

Figure 6. 2<sup>nd</sup> Valley Operation @ 35 W / 115 V rms

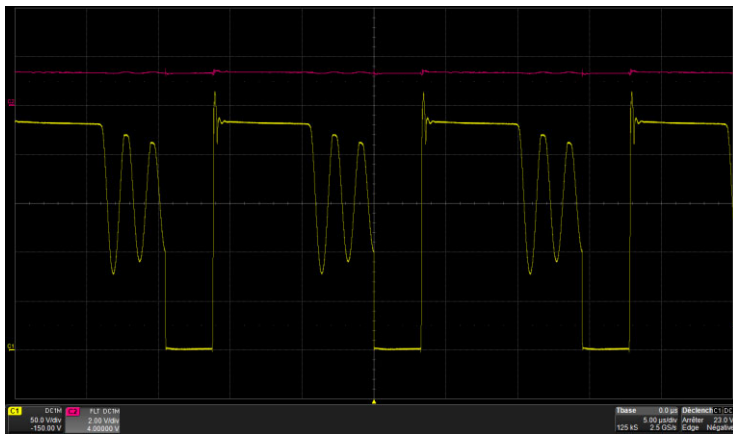

Figure 7. 3<sup>rd</sup> Valley Operation @ 25 W / 115 V rms

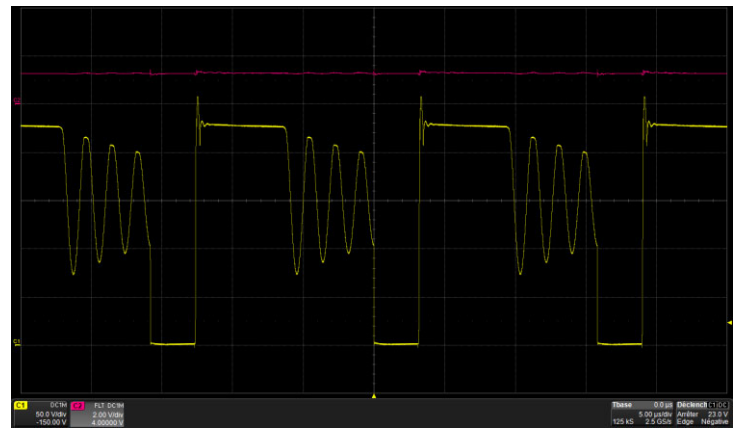

Figure 8. 4<sup>th</sup> Valley Operation @ 20 W / 115 V rms

# NCP1339GEVB

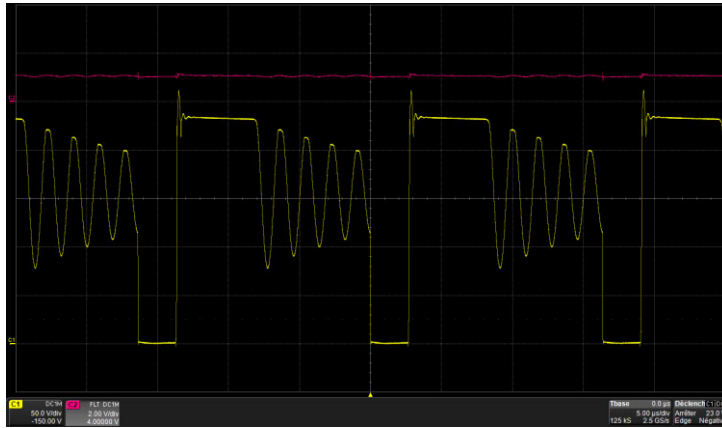

Figure 9. 5<sup>th</sup> Valley Operation @ 15 W / 115 V rms

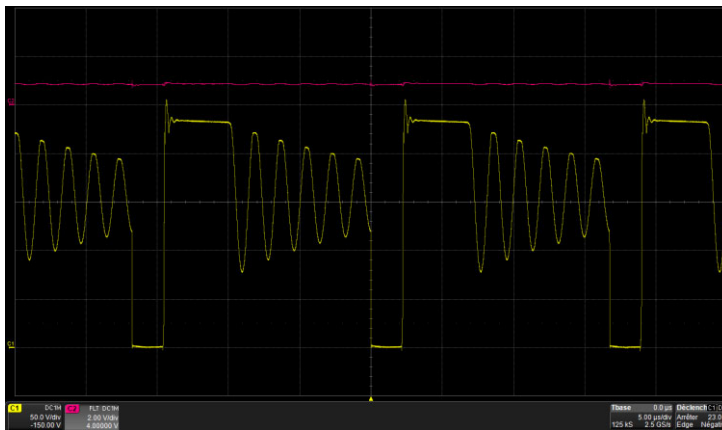

Figure 10. 6<sup>th</sup> Valley Operation @ 10 W / 115 V rms

## Frequency Foldback Mode

If while operating at valley 6, the load further decreases, the NCP1339 will operate in Frequency Foldback (FF) mode. Practically, the circuit enters in FF mode when FB voltage drops below 0.8 V. The current is frozen to 25% of its maximum value and regulation is made by varying the

switching frequency ( $f_{sw}$  reduces if the power demand diminishes).

In this 45 W evaluation boards, at 115 V rms, the switching frequency is around 48.5 kHz @ 7 W and falls to 27.6 kHz for an output power of 4 W.

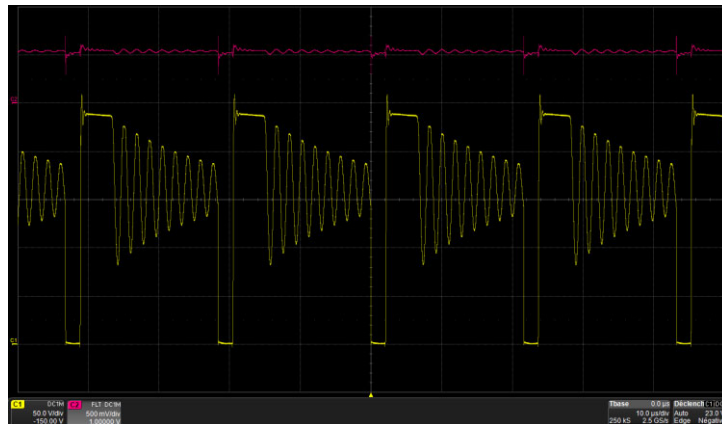

Figure 11. FF Mode @ 7 W / 115 V rms

## NCP1339GEVB

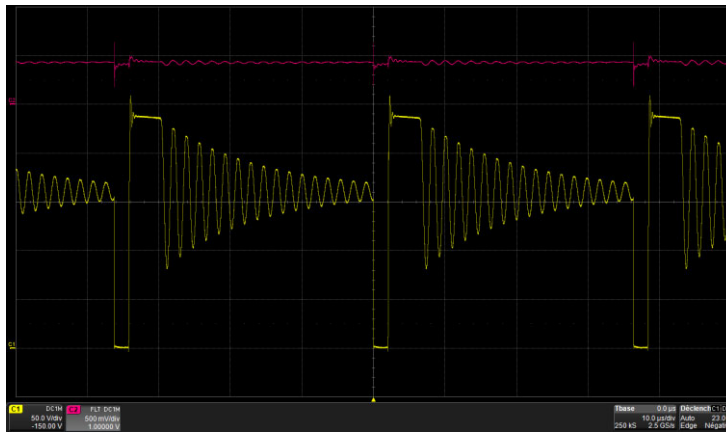

Figure 12. FF Mode @ 4 W / 115 V rms

### 25 kHz Frequency Clamp and Skip Mode

The circuit prevents the switching frequency from dropping below 25 kHz in order to avoid acoustic noise. When the switching cycle is longer than 40  $\mu$ s, the circuit forces a new switching cycle. Since the NCP1339 forces a minimum peak current and a minimum frequency (25 kHz

typically), the power delivery cannot be continuously controlled down to zero. Instead, the circuit stops pulsing when the FB voltage drops below 400 mV and recovers operation when  $V_{FB}$  exceeds 450 mV (50-mV hysteresis). Figure 13 shows controller operation in this skip mode.

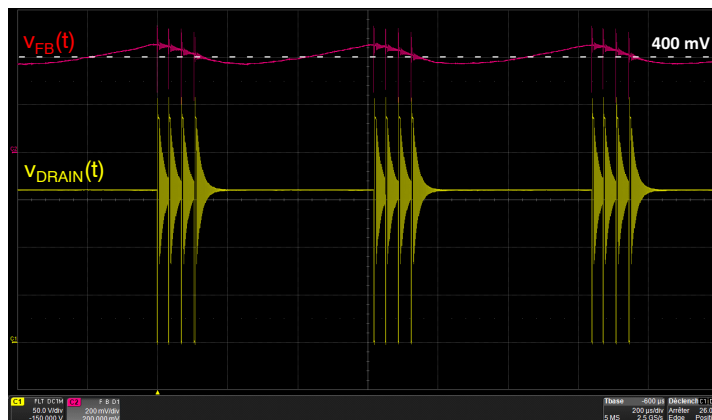

Figure 13. Skip Cycle Mode in Light Load (1 W @ 115 V rms)

### Power Savings Mode (PSM)

If application requires ultra-low input power consumption in stand-by, NCP1339 controller embedded a dedicated input, through REM pin, to reduce the consumption to few mW. The controller enters in PSM mode as soon as the RME pin is pulled up above a certain level. At this time, the controller enters in sleep mode and output voltage is not regulated anymore. The off time duration is

defined by  $C_{28}$ ,  $R_{53}$  and  $R_{54}$ . REM pin voltage slowly decreasing and it drops below 1.5 V, the controller automatically restarts to charge up  $C_{28}$  above 8 V through auxiliary winding and enters in new off sequence (4 min 30 s in our example Figure 14).

When the REM is actively pulled down via a dedicated output optocoupler, the adapter immediately re-starts as described in Figure 15.

# NCP1339GEVB

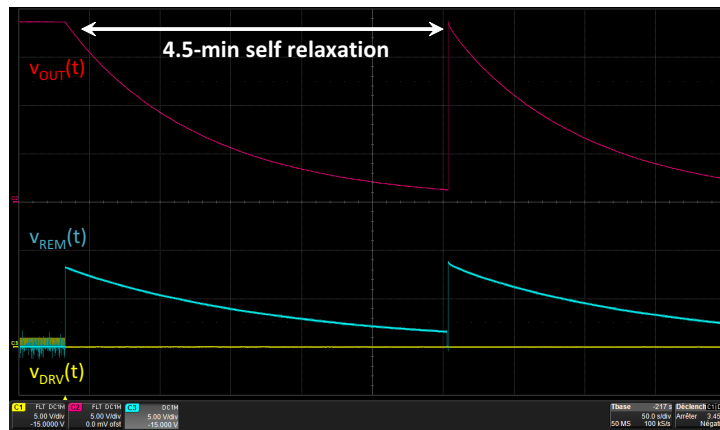

Figure 14. Power Savings Mode

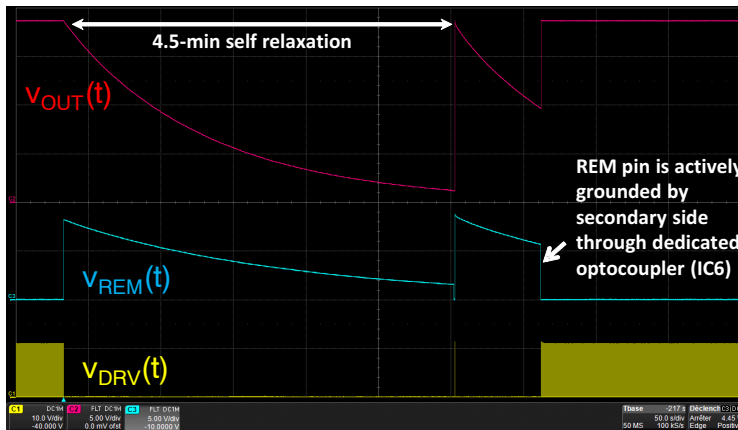

Figure 15. PSM – Wake up with Secondary Side Signal through Dedicated Optocoupler

## Brown-out protection

The NCP1339 controller embedded the Brown-out (BO) function via HV pin. The BO thresholds are fixed (101 V line

rising, 93 V falling, typically). Figure 16 shows typically signals during line dropout test.

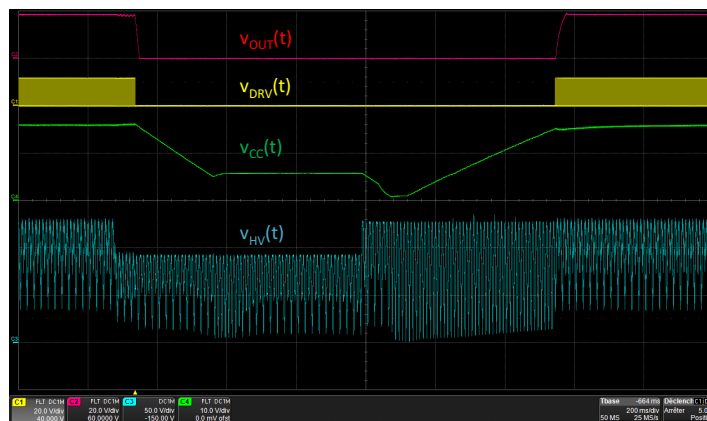

Figure 16. Line Drop-out Test

## X2 discharge

All PSU need input filter to reduce EMI emission. X2 capacitor helps in this task but when you unplug the adaptor, the voltage on ac terminals can stays to the input peak voltage. IEC-950 standard impose to reduce the voltage on

its terminals below a sufficient pace when you unplug the power cord so that the available level becomes benign for a user touching the plug after 1 s. This is the reason why discharge resistors are connected in parallel with the filtering capacitor.



# NCP1339GEVB

In order to save the power dissipation in the X2 capacitor discharge resistance and so increase the general board efficiency, X2 discharge function is directly implemented on

the controller. A dedicated X2 pin senses the input voltage to detect when the mains disappears, typically when the PSU is un-plugged.

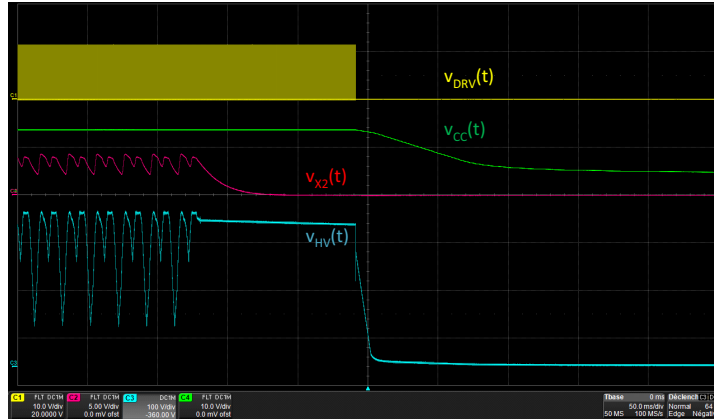

Figure 17. X2 Capacitor Discharge Function

## Transient load

Figure 18 and Figure 19 show an output transient load step from 10% to 100% of the maximum output power at low line and high line. The slew rate is 1 A/ $\mu$ s and the frequency is 20 Hz.

The step load response is  $\pm 220$  mV or  $\pm 1.2\%$  of the output voltage.

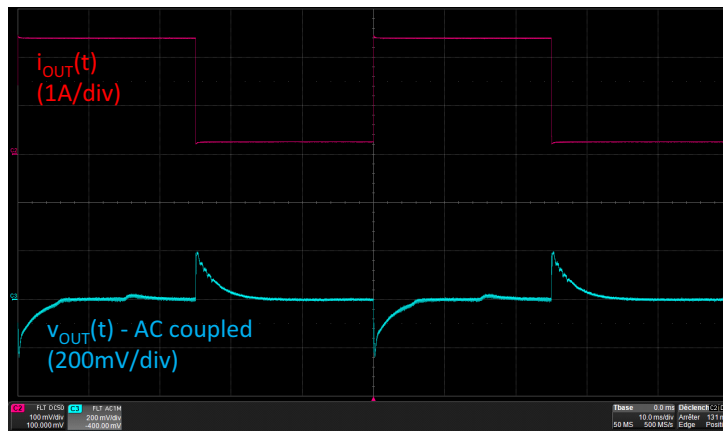

Figure 18. Step Load Response between 10% to 100% @ 115 V rms

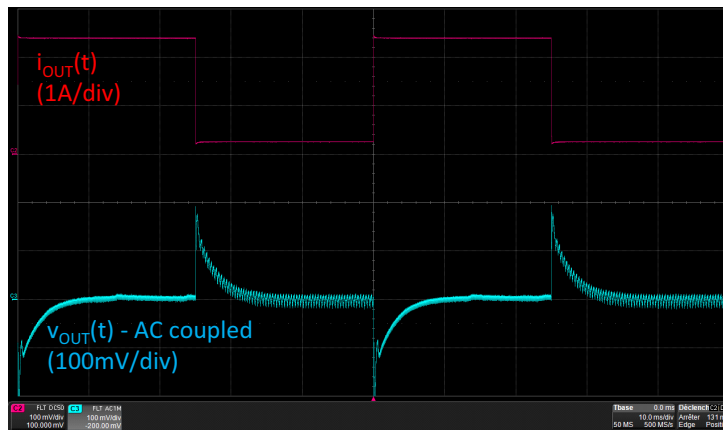

Figure 19. Step Load Response between 10% to 100% @ 230 V rms

## NCP1339GEVB

**Table 3. BILL OF MATERIAL (BOM)**

Designator	Qty	Description	Value	Tolerance	Manufacturer
C1	1	Y1 capacitor, 250 V	2.2 nF	250 V	CERAMITE
C2	1	X2 capacitor, 305 V	330 nF	305 V	EPCOS
C3	1	X2 capacitor, 305 V	220 nF	305 V	EPCOS
C4	1	Electrolytic capacitor, 400 V	120 $\mu$ F	400 V	RUBYCON
C5, C6, C9, C13	4	Ceramic Capacitor, SMD, 50 V	1 nF	10%, 50 V	Standard
C7	1	Ceramic capacitor, SMD, 50 V	2.2 nF	10%, 50 V	Standard
C8	1	Ceramic capacitor, SMD, 50 V	22 pF	10%, 50 V	Standard
C10, C14, C18	3	Ceramic Capacitor, SMD, 50 V	220 pF	10%, 50 V	Standard
C11	1	Ceramic Capacitor, Axial, 1000V	1.5 nF	10%, 1000 V	VISHAY
C12, C21	2	Electrolytic capacitor, 35 V	220 $\mu$ F	20%, 35 V	Standard
C15	1	Ceramic capacitor, SMD, 50 V	100 nF	10%, 50 V	Standard
C16	1	Ceramic Capacitor, Axial, 1000V	100 pF	10%, 1000 V	MURATA
C19, C20	2	Electrolytic capacitor, 35 V	680 $\mu$ F	35 V, 2.4 A	RUBYCON
C27	1	Ceramic capacitor, SMD, 50 V	47 nF	10%, 50 V	Standard
C28	1	Electrolytic capacitor, 35 V	22 $\mu$ F	20%, 35 V	Standard
C29	1	Ceramic capacitor, SMD, 50 V	10 nF	10%, 50 V	Standard
D1, D2	2	Diode, Axial, 1A, 1000V	MRA4007	1 A, 1000 V, SMA	ON Semiconductor
D3, D4, D9	3	Diode, SMD, 100 V	D1N4148	100 V	Standard
D5	1	18 V Zener Diode, Axial	zener	18 V, DO-35	Standard
D6, D7	2	Fast Recovery Diode, Axial, 1 A, 600 V	D1N4937	1 A, 600 V, DO-35	ON Semiconductor
D10	1	Diode, Axial, 200 mA, 250V	BAV21	200 mA, 250 V, DO-35	Standard
D12	1	Schottky Diode, TO-220, 20 A, 150 V	MBR20H150	20 A, 150 V, TO-220	ON Semiconductor
HS1, HS2	2	Heatsink, 13°C/W, For M1 & D12		13°C/W	AAVID THERMALLOY
HSC1, HSC2	2	Heatsink clip for TO-220, For M1 & D12			AAVID THERMALLOY
IC1	1	QR controller			ON Semiconductor
IC2	1	Diode Bridge, 4 A, 800 V	KBU4K		MULTICOMP
IC4, IC6	2	Optocoupler SFH6156-2, SMD	SFH6156-2		VISHAY
IC5	1	Shunt Regulator, 2.5 – 36 V, 1 – 100 mA	NCP431		ON Semiconductor
F1	1	Fuse, 2 A, 250 V	2 A, 250 V		SCHURTER
J1	1	Input Connector, 2.5 A, 260 V		2.5 A, 260 V	MULTICOMP
J2	1	Output Connector		10 A, 300 V	WEIDMULLER
J3	1	Test point			Keystone
L1	1	Differential Mode Choke, 300 $\mu$ H, 2A	300uH	2 A	WURTH
L2	1	Common Mode Choke, 2*10 mH, 2 A	10mH	2 A	WURTH
L3	1	Radial Coil, 2.2 $\mu$ H, 6 A, 20%	2.2uH	6 A, 20%	WURTH
M1	1	MOSFET, 600 V, 7 A	IPP60R385	7 A, 600 V	INFINEON
Q1	1	PNP transistor, SMD	BC857		ON Semiconductor
R1, R2	2	Resistor, Axial, 3 W, 5%	18 k $\Omega$	3 W, 5%	Standard

# NCP1339GEVB

**Table 3. BILL OF MATERIAL (BOM)**

Designator	Qty	Description	Value	Tolerance	Manufacturer
R3	1	Resistor, Axial, 1 W, 1%	10 $\Omega$	1%	Standard
R4, R5	2	Ceramic Resistor, SMD, 0.25 W, 50 V	2.7 k $\Omega$	5%	Standard
R6	1	Ceramic Resistor, SMD, 0.25 W, 50 V	5.6 M $\Omega$	5%	Standard
R7, R8	2	Ceramic Resistor, SMD, 0.25 W, 50 V	4.7 M $\Omega$	5%	Standard
R9	1	Ceramic Resistor, SMD, 0.25 W, 50 V	10 M $\Omega$	5%	Standard
R10	1	Ceramic Resistor, SMD, 0.25 W, 50 V	20 k $\Omega$	5%	Standard
R11	1	Ceramic Resistor, SMD, 0.25 W, 50 V	300 k $\Omega$	5%	Standard
R12	1	Ceramic Resistor, SMD, 0.25 W, 50 V	1.5 k $\Omega$	5%	Standard
R13	1	NTC, 100 k $\Omega$ at 25°C, Beta = 4190	100 k $\Omega$ @ 25°C	0.05	VISHAY
R14, R21, R40	3	Ceramic Resistor, SMD, 0.25 W, 50 V	1 k $\Omega$	5%	Standard
R15	1	Ceramic Resistor, SMD, 0.25 W, 50 V	10 $\Omega$	5%	Standard
R16	1	Ceramic Resistor, SMD, 0.25 W, 50 V	47 k $\Omega$	5%	Standard
R17	1	Ceramic Resistor, SMD, 1 W, 1%, 50 V	0.47 $\Omega$	1 W, 1%	Standard
R18	1	Ceramic Resistor, SMD, 1 W, 1%, 50 V	0.62 $\Omega$	1 W, 1%	Standard
R20	1	Ceramic Resistor, SMD, 0.25 W, 50 V	47 $\Omega$	5%	Standard
R22, R29	2	Ceramic Resistor, SMD, 0.25 W, 50 V	10 k $\Omega$	5%	Standard
R23	1	Ceramic Resistor, SMD, 0.25 W, 50 V	27 k $\Omega$	5%	Standard
R25	1	Ceramic Resistor, SMD, 0.25 W, 50 V	39 k $\Omega$	5%	Standard
R27, R42, R52	3	Ceramic Resistor, SMD, 0.25 W, 50 V	0 $\Omega$	5%	Standard
R53	1	Ceramic Resistor, SMD, 0.25 W, 50 V	2.2 M $\Omega$	5%	Standard
R54	1	Ceramic Resistor, SMD, 0.25 W, 50 V	8.2 M $\Omega$	5%	Standard
T1	1	QR Transformer	17212		CME

## Conclusion

This application note has described the results obtained for 45 W Quasi-resonant flyback topology with NCP1339 controller.

Due to the valley lockout, the NCP1339 allows building QR adapter without valley jumping.

The controller offers all necessary protections needed to safe power supply.

Thanks to the high voltage current source and X2 capacitor discharge embedded on controller, stand-by power consumption was measured below 45 mW. This stand-by consumption can be further reduced by activating power savings mode.

ON Semiconductor and the ON Semiconductor logo are trademarks of Semiconductor Components Industries, LLC dba ON Semiconductor or its subsidiaries in the United States and/or other countries. ON Semiconductor owns the rights to a number of patents, trademarks, copyrights, trade secrets, and other intellectual property. A listing of ON Semiconductor's product/patent coverage may be accessed at [www.onsemi.com/site/pdf/Patent-Marking.pdf](http://www.onsemi.com/site/pdf/Patent-Marking.pdf). ON Semiconductor is an Equal Opportunity/Affirmative Action Employer. This literature is subject to all applicable copyright laws and is not for resale in any manner.

The evaluation board/kit (research and development board/kit) (hereinafter the "board") is not a finished product and is as such not available for sale to consumers. The board is only intended for research, development, demonstration and evaluation purposes and should as such only be used in laboratory/development areas by persons with an engineering/technical training and familiar with the risks associated with handling electrical/mechanical components, systems and subsystems. This person assumes full responsibility/liability for proper and safe handling. Any other use, resale or redistribution for any other purpose is strictly prohibited.

The board is delivered "AS IS" and without warranty of any kind including, but not limited to, that the board is production-worthy, that the functions contained in the board will meet your requirements, or that the operation of the board will be uninterrupted or error free. ON Semiconductor expressly disclaims all warranties, express, implied or otherwise, including without limitation, warranties of fitness for a particular purpose and non-infringement of intellectual property rights.

ON Semiconductor reserves the right to make changes without further notice to any board.

You are responsible for determining whether the board will be suitable for your intended use or application or will achieve your intended results. Prior to using or distributing any systems that have been evaluated, designed or tested using the board, you agree to test and validate your design to confirm the functionality for your application. Any technical, applications or design information or advice, quality characterization, reliability data or other services provided by ON Semiconductor shall not constitute any representation or warranty by ON Semiconductor, and no additional obligations or liabilities shall arise from ON Semiconductor having provided such information or services.

The boards are not designed, intended, or authorized for use in life support systems, or any FDA Class 3 medical devices or medical devices with a similar or equivalent classification in a foreign jurisdiction, or any devices intended for implantation in the human body. Should you purchase or use the board for any such unintended or unauthorized application, you shall indemnify and hold ON Semiconductor and its officers, employees, subsidiaries, affiliates, and distributors harmless against all claims, costs, damages, and expenses, and reasonable attorney fees arising out of, directly or indirectly, any claim of personal injury or death associated with such unintended or unauthorized use, even if such claim alleges that ON Semiconductor was negligent regarding the design or manufacture of the board.

This evaluation board/kit does not fall within the scope of the European Union directives regarding electromagnetic compatibility, restricted substances (RoHS), recycling (WEEE), FCC, CE or UL, and may not meet the technical requirements of these or other related directives.

**FCC WARNING** – This evaluation board/kit is intended for use for engineering development, demonstration, or evaluation purposes only and is not considered by ON Semiconductor to be a finished end product fit for general consumer use. It may generate, use, or radiate radio frequency energy and has not been tested for compliance with the limits of computing devices pursuant to part 15 of FCC rules, which are designed to provide reasonable protection against radio frequency interference. Operation of this equipment may cause interference with radio communications, in which case the user shall be responsible, at its expense, to take whatever measures may be required to correct this interference.

ON Semiconductor does not convey any license under its patent rights nor the rights of others.

**LIMITATIONS OF LIABILITY:** ON Semiconductor shall not be liable for any special, consequential, incidental, indirect or punitive damages, including, but not limited to the costs of requalification, delay, loss of profits or goodwill, arising out of or in connection with the board, even if ON Semiconductor is advised of the possibility of such damages. In no event shall ON Semiconductor's aggregate liability from any obligation arising out of or in connection with the board, under any theory of liability, exceed the purchase price paid for the board, if any.

For more information and documentation, please visit [www.onsemi.com](http://www.onsemi.com).

---

## PUBLICATION ORDERING INFORMATION

### LITERATURE FULFILLMENT:

Email Requests to: [orderlit@onsemi.com](mailto:orderlit@onsemi.com)

ON Semiconductor Website: [www.onsemi.com](http://www.onsemi.com)

### TECHNICAL SUPPORT

North American Technical Support:

Voice Mail: 1 800-282-9855 Toll Free USA/Canada

Phone: 011 421 33 790 2910

Europe, Middle East and Africa Technical Support:

Phone: 00421 33 790 2910

For additional information, please contact your local Sales Representative