

ON Semiconductor

Is Now

onsemi™

To learn more about onsemi™, please visit our website at
www.onsemi.com

onsemi and **onsemi** and other names, marks, and brands are registered and/or common law trademarks of Semiconductor Components Industries, LLC dba "**onsemi**" or its affiliates and/or subsidiaries in the United States and/or other countries. **onsemi** owns the rights to a number of patents, trademarks, copyrights, trade secrets, and other intellectual property. A listing of **onsemi** product/patent coverage may be accessed at www.onsemi.com/site/pdf/Patent-Marking.pdf. **onsemi** reserves the right to make changes at any time to any products or information herein, without notice. The information herein is provided "as-is" and **onsemi** makes no warranty, representation or guarantee regarding the accuracy of the information, product features, availability, functionality, or suitability of its products for any particular purpose, nor does **onsemi** assume any liability arising out of the application or use of any product or circuit, and specifically disclaims any and all liability, including without limitation special, consequential or incidental damages. Buyer is responsible for its products and applications using **onsemi** products, including compliance with all laws, regulations and safety requirements or standards, regardless of any support or applications information provided by **onsemi**. "Typical" parameters which may be provided in **onsemi** data sheets and/or specifications can and do vary in different applications and actual performance may vary over time. All operating parameters, including "Typicals" must be validated for each customer application by customer's technical experts. **onsemi** does not convey any license under any of its intellectual property rights nor the rights of others. **onsemi** products are not designed, intended, or authorized for use as a critical component in life support systems or any FDA Class 3 medical devices or medical devices with a same or similar classification in a foreign jurisdiction or any devices intended for implantation in the human body. Should Buyer purchase or use **onsemi** products for any such unintended or unauthorized application, Buyer shall indemnify and hold **onsemi** and its officers, employees, subsidiaries, affiliates, and distributors harmless against all claims, costs, damages, and expenses, and reasonable attorney fees arising out of, directly or indirectly, any claim of personal injury or death associated with such unintended or unauthorized use, even if such claim alleges that **onsemi** was negligent regarding the design or manufacture of the part. **onsemi** is an Equal Opportunity/Affirmative Action Employer. This literature is subject to all applicable copyright laws and is not for resale in any manner. Other names and brands may be claimed as the property of others.



ON Semiconductor

A 15 Watt, Triple Output, Ultra Wide Range AC Input Power Supply

Device	Application	Input Voltage	Output Power	Topology	I/O Isolation
NCP1251B NCP431	E-Meters, Industrial Equipment	85 to 520 Vac	15W Nominal, 20W Peak	Flyback	Yes

Other Specification

	Output 1	Output 2	Output 3	Output 4
Output Voltage	5.0 V	5.0 V	12.0 V	N/A
Ripple (P/P Max)	150 mV	100 mV	150 mV	N/A
Nominal Current	2 Amps	100 mA	400 mA	N/A
Max Current	2.5 Amps	100 mA	700 mA	N/A
Min Current	0	0	10 mA	N/A

PFC (Yes/No)	No
Minimum Efficiency	70% at 15W out and 480Vac input
Inrush Limiting / Fuse	Yes
Operating Temp. Range	-40 ~ 85C
Cooling Method / Supply Orientation	Convection
Signal Level Control	NA

Others	All outputs isolated from each other; linear regulator options for output channels 2 and 3.
---------------	---

Circuit Description

The Design Note provides the technical details for a 15 watt nominal, 20 watt peak output power supply design which will operate over a 6:1 AC input line range and provide 3 fully isolated output voltages. The channel 1 output provides a dedicated 5 volt output at up to 2.5 amps. The second channel includes a 3-terminal regulator so as to provide a highly regulated, low ripple, low current output. In this demo board, a second 5 volt output with up to 100 mA is provided. The 3rd channel is a quasi-regulated 12 volt output which will provide up to 700 mA, however, the option for another 100 mA, 3-terminal regulator is also provided in the event this channel needs to have a highly regulated output.

The flyback power converter is designed around ON Semiconductor's NCP1251B current mode controller (TSOP-6 package) and a 6 amp, 900 volt MOSFET. The flyback operates in continuous conduction mode (CCM) for most of the mid to upper load range. This mode was chosen to allow optimization of the transformer design and to achieve a turns ratio that would allow efficient operation from 85 to 520 Vac input and still minimize

voltage stresses on the output rectifiers and the power MOSFET. Although a heatsink is not used on the TO-220 MOSFET Q1 in the demo board, it is recommended that a small one be used on the device if continuous operation at 15 watts is anticipated in an elevated ambient environment.

This Design Note is essentially an extension of ON Semiconductor Design Note DN05017 which describes a 10 watt, 12 volt output supply with an identical wide range AC input.

Plots and oscilloscope screen captures are presented below to illustrate performance examples.

Key Features

- Input EMI filter for EN55022 conducted emission compliance.
- Over current and over voltage protection.
- Excellent regulation with standard NCP431 and optocoupler feedback scheme to NCP1251.
- Three fully isolate outputs with 3-T regulator options on outputs 2 and 3.

DN05039/D

Schematic

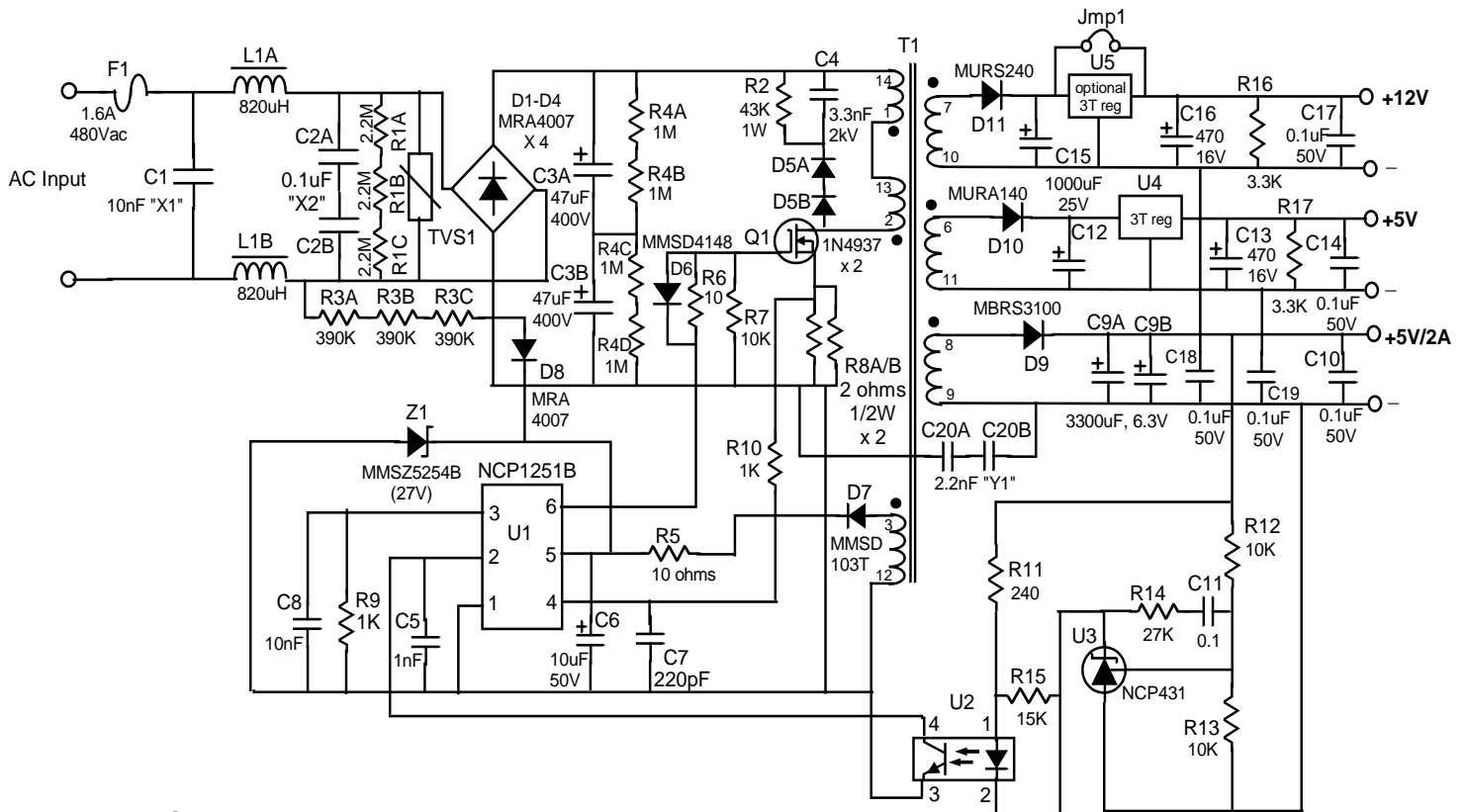

NOTES:

1. Crossed lines on schematic are NOT connected.
2. U2 is NEC PS2561L-1 or equivalent optocoupler (CTR > 50%).
3. C1 is 480Vac rated ceramic disk capacitor ("X" or "Y" types OK)
4. L1A/L1B are Wurth 7447728215 components (820 uH, 500mA).
5. Output caps (C9A/B, C12, C15) are radial lead, low impedance types (UCC LXV series or similar).
6. R5 is for Vcc trimming (< 28Vmax), typically zero to 10 ohms.
7. R8A/B sets max output current.
8. TVS1 is optional transient voltage suppressor.
9. C15 & C16 should be 480Vac rated "Y1" cap.
10. Q1 is 900V or higher, 3A rated Mosfet.
11. Jmp1 is optional jumper if regulator U5 is not used.
12. See drawing for T1 details.

**15 Watt, Triple Output NCP1251 Power Supply
with Ultra-Wide AC Input (Rev 4A)**

MAGNETICS DESIGN DATA SHEET

Project / Customer: ON Semiconductor - 20 watt, Multiple output NCP1251 Flyback

Part Description: 20 watt flyback transformer, triple output (5V/8V/12V), 100 kHz

Schematic ID: T1

Core Type: EE20/10/6 ferrite core; 3C90 material or similar

Core Gap: Gap for 180 to 220uH across Primary A (pins 1 - 10)

Inductance: 800 uH total (+/- 10%) measured from pin 1 to pin 9 with pins 2 and 10 connected

Bobbin Type: 14 pin horizontal mount for EE20/10/6

Windings (in order):

Winding # / type	Turns / Material / Gauge / Insulation Data
Primary A (1 - 14)	28T of #28 mag wire over 1 layer (28 TPL). Insulate for 1 kV to next winding. Self leads to pins.
Vcc (3 - 12)	11 turns of #28 mag wire over 1 layer, spiral wound over primary A. Self leads to pins. Insulate to 1 kV to next winding with tape.
5V Secondary (8 - 9)	4 turns bifilar of #24 triple insulated wire over one. layer (two strands) - spiral wind. Self leads to single pin as shown in drawing below.
12V Secondary (7 - 10)	9 turns of #26 triple insulated wire spiral wound over 1 layer. Self leads to pins.
8V Secondary (6 - 11)	6 turns of #26 triple insulated wire spiral wound over 1 layer. Self leads to pins

NOTE: Despite having different turns, it would be desirable to wind the 12v and 8V secondaries semi bifilar if possible.

Primary B (2 - 13) Same as Primary A. Insulate with tape and self-leads to pins.

Hipot: 2.5 kV from primaries & Vcc to secondaries for 1 minute.

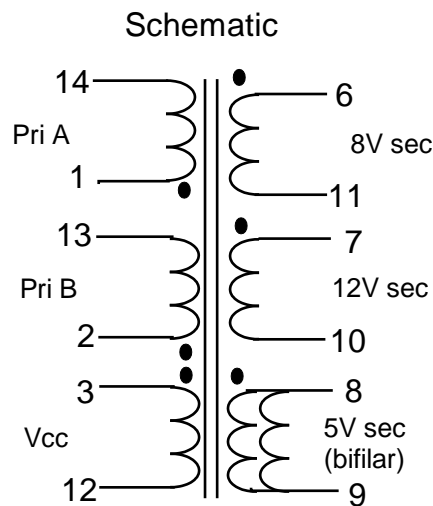

Lead Breakout / Pinout

(Bottom View of Bobbin)

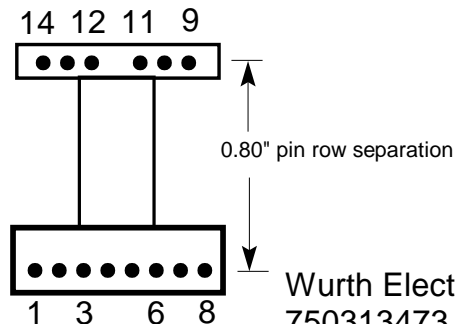

Würth Electronics Part
750313473 Rev 01

Board Information

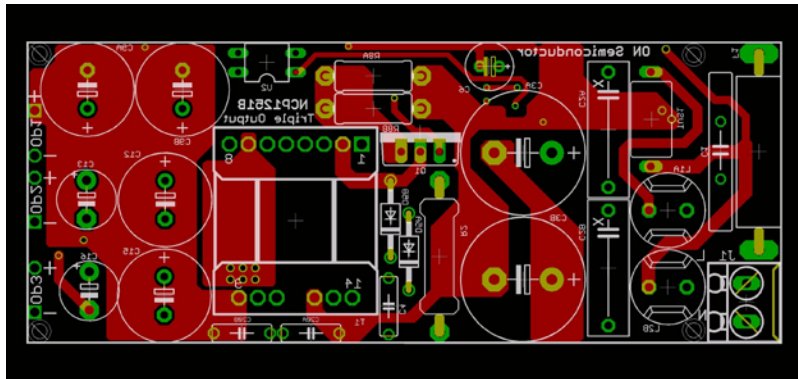
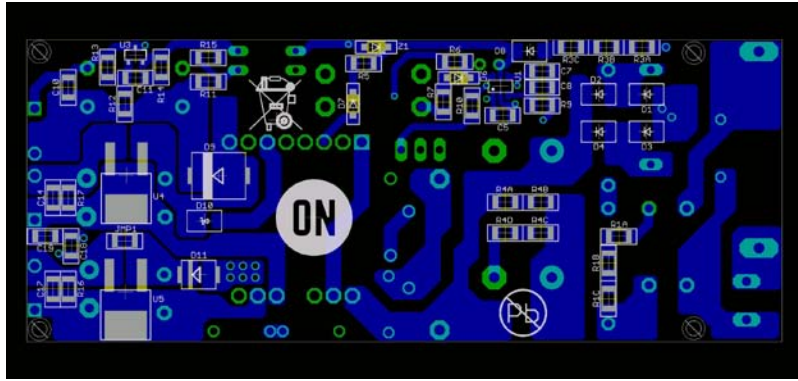

Dimensions: 100mm x 40mm

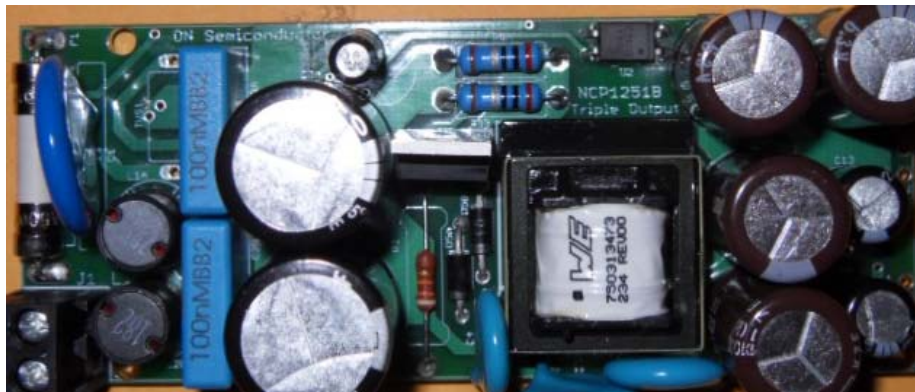

Efficiency versus Line Voltage

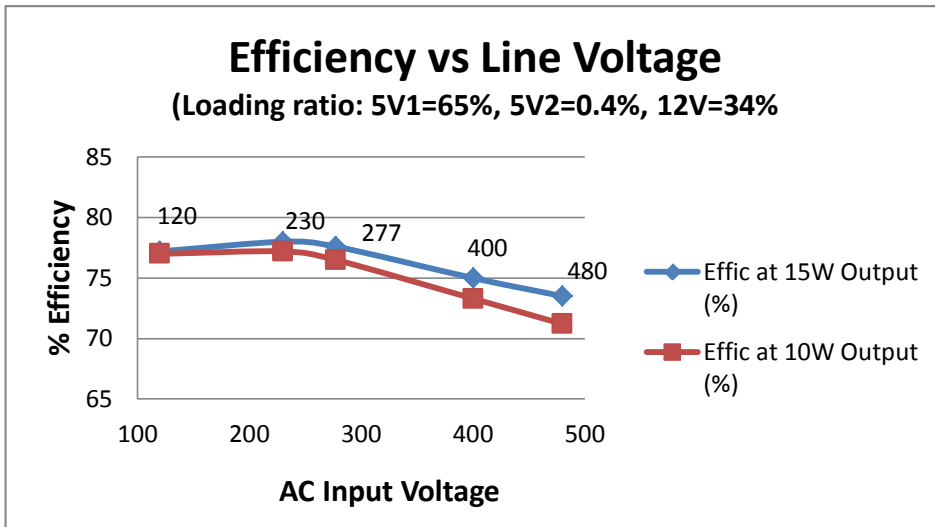

12 Vout Load Regulation (5 Vout1 set at 1.5 amps)

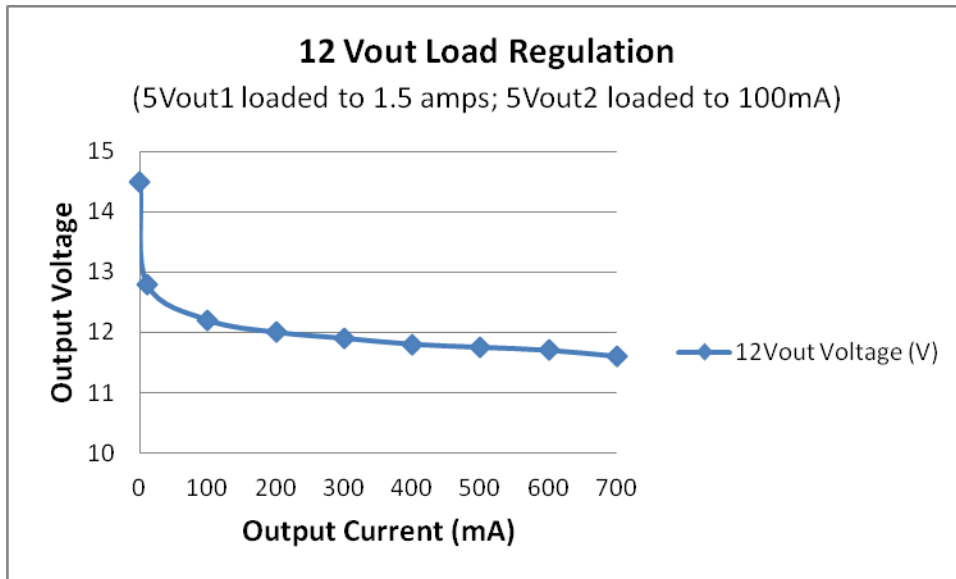

Drain-to-Source Voltage Profile at 120 Vac, 230 Vac, and 480 Vac Inputs
 (15 watts output; vertical scale is 100V per division)

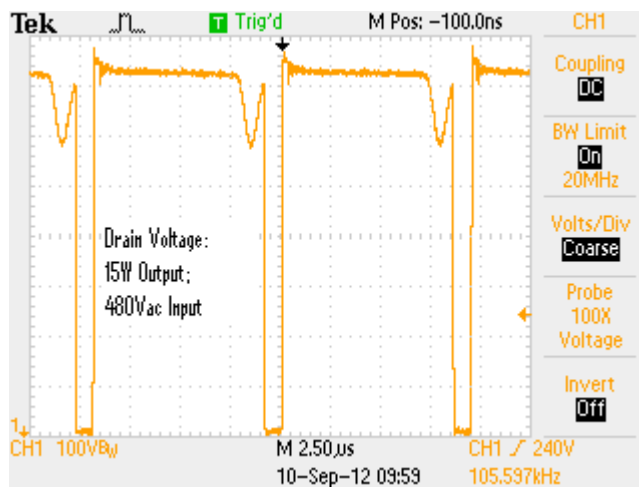
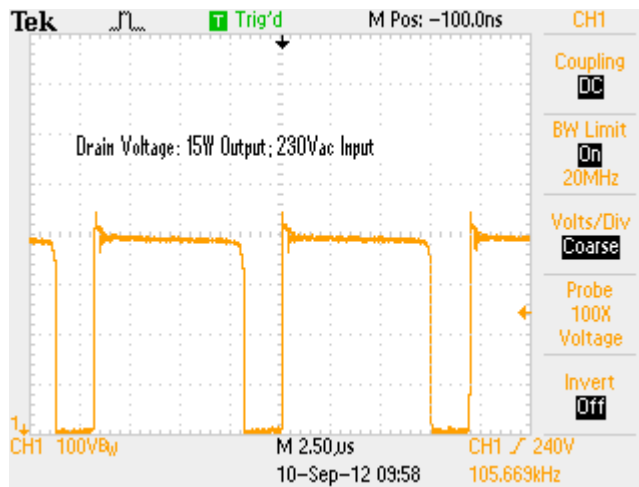
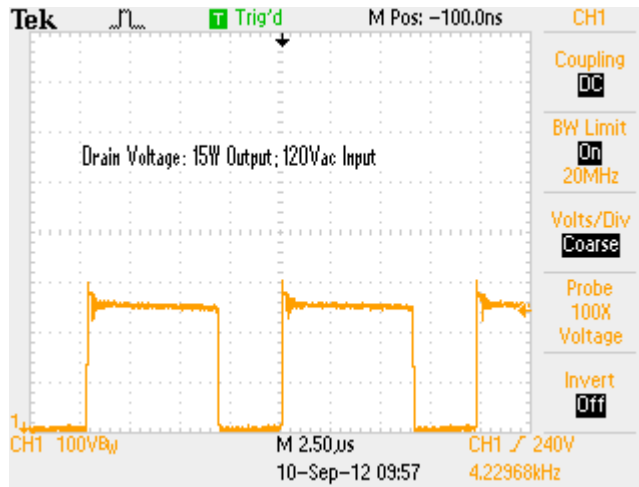

Output Ripple (15 watt total load; 230 Vac input)

Output 1 (5 V at 2 A)

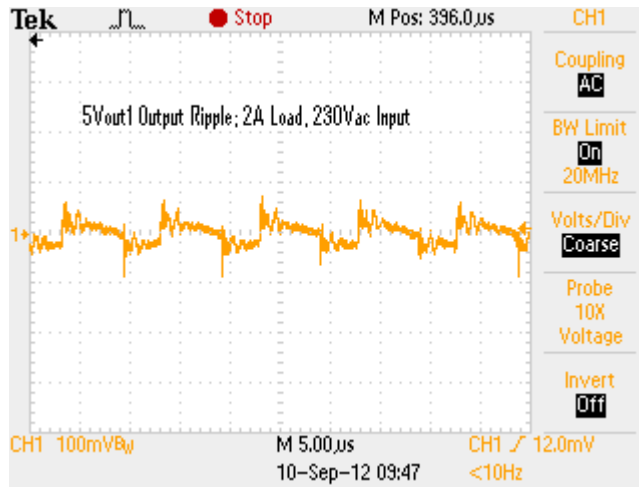

Output 2 (5 V at 100 mA)

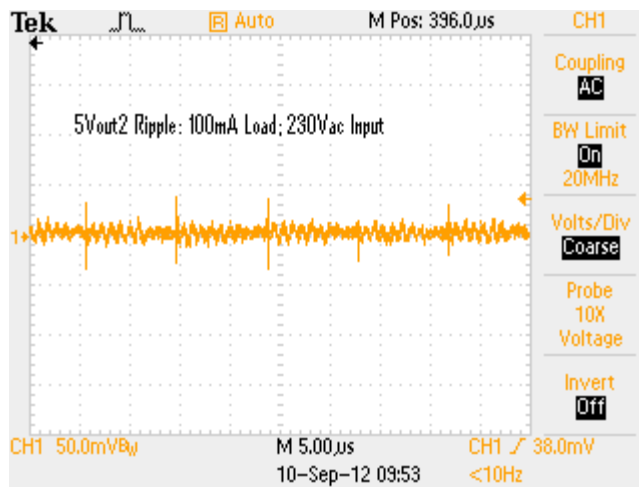

Output 3 (12 V at 500 mA)

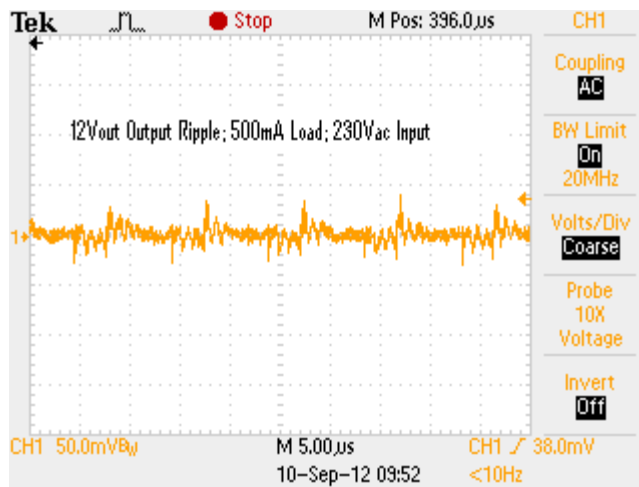

Conducted EMI Profile (EN55022, Level B, 240 Vac input)

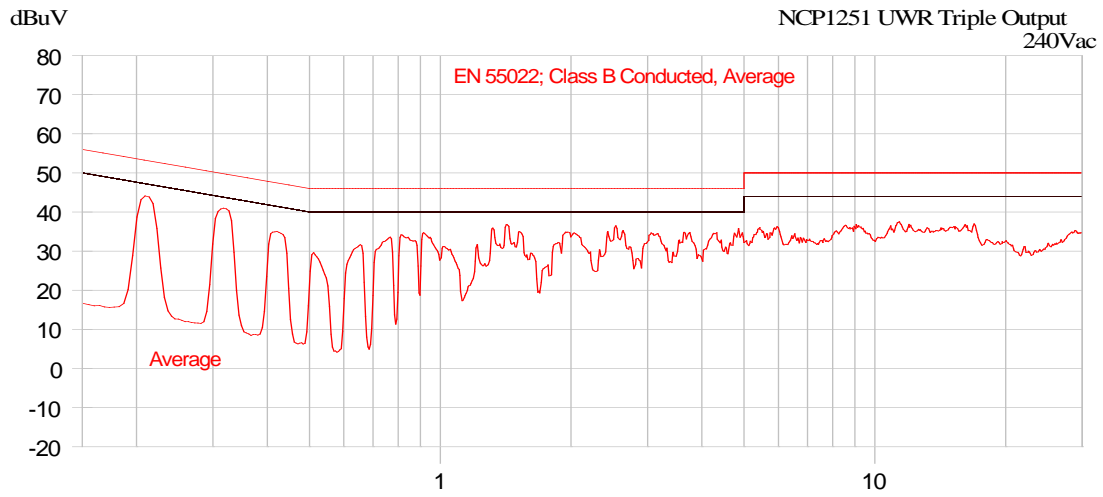

10/25/2012 11:14:51 AM

(Start = 0.15, Stop = 30.00) MHz

DN05039/D

Bill of Materials for 20W, NCP1251, Triple Output, Ultra-Wide Input Flyback (Rev 4A)

ON Semiconductor



9/7/2012

Designator	Qty	Description	Value	Tolerance	Footprint	Manufacturer	Manufacturer Part Number	Substitution Allowed	Lead Free
D9	1	Schottky diode	3A, 100V		SMC	ON Semi	MBRS3100	No	Y
D10	1	UFR Diode	1A, 400V		SMA	ON Semi	MURA140T3G	No	Y
D11	1	UFR Diode	2A, 400V		SMB	ON Semi	MURS240T3G	No	
Q1	1	Mosfet - 5A/900V	5A, 900V		TO-220	Fairchild / Infineon	FQP6N90C / IPP90R800C3	Yes	
D1, 2, 3, 4, 8	5	Diode - 60 Hz,	1A, 1kV		SMA	ON Semi	MRA4007	No	
D5A, D5B	1	Diode - fast recov	1A, 600V		axial lead	ON Semi	1N4937	No	
D6	1	Signal diode	100mA, 100V		SOD-123	ON Semi	MMSD4148A	No	
D7	1	Signal diode	100mA, 250V		SOD-123	ON Semi	MMSD103T1G	No	
Z1	1	Zener diode	27V, 500mA		SOD-123	ON Semi	MMSZ5254B	No	
U3	1	Programmable zener	2.5V		SOT23	ON Semi	NCP431A	No	
U2	1	Optocoupler	CTR >= 0.5		4-pin	Vishay or NEC	SFH6156A-4 or PS2561L-1	Yes	
U1	1	Controller - NCP1251B	100 kHz		TSOP-6	ON Semi	NCP1251B	No	
U4	1	3-T regulator	5V, 100 mA		DPak3	ON Semi	LM2931	No	
U5	1	3-T regulator	TBD		DPak3	ON Semi	TBD	No	
C2A, C2B	2	"X2" cap, box type	100nF, 270Vac		LS=15mm	Kemet	Digi-Key P/N = 399-5426-ND	Yes	
C1	1	"X1" cap, disc type	10nF, 440Vac		LS=7.5mm, D=21mm	Rifa	TBD	Yes	
C20A, B	2	Y1 cap - ceramic disc	2.2nF, 2kV		LS = 7.5 mm	Rifa, Wima	TBD		
C4	1	Ceramic cap, disc (snubber)	3.3nF, 2kV	5%	LS = 7.5 mm	Rifa, Wima, Vishay	TBD	Yes	
C5	1	Ceramic cap, monolythic	1 nF, 50V	10%	1206	AVX, Murata	TBD	Yes	
C8	1	Ceramic cap, monolythic	10nF, 50V		1206	AVX, Murata	TBD		
C10,11,14,17,18,19	6	Ceramic cap, monolythic	100nF, 50V	10%	1206	AVX, Murata	TBD	Yes	
C7	1	Ceramic cap, monolythic	220pF, 50V	5%	1206	AVX, Murata	TBD	Yes	
C3A, C3B	2	Electrolytic cap	47uF, 400V	10%	LS=7.5mm, D=16mm	UCC, Panasonic	TBD	Yes	
C6	1	Electrolytic cap	10uF, 50Vdc	10%	LS=2.5mm, D=6.3mm	UCC, Panasonic	TBD	Yes	
C9A, C9B	2	Electrolytic cap	3,300uF, 6.3V	10%	LS=5mm, D=12.5mm	UCC, Panasonic	TBD	Yes	
C12, C15	2	Electrolytic cap	1000uF, 25V	10%	LS=5mm, D=12.5mm	UCC, Panasonic	TBD		
C13, C16	2	Electrolytic cap	330 or 470uF, 16V	10%	LS=5mm, D=8mm	UCC, Panasonic	TBD		
R2	1	Resistor, 1W, metal film	43K, 1W	10%	Axial lead; LS=20mm	Ohmite, Dale	TBD	Yes	
R8A, R8B	2	Resistor, 1/2W metal film	2.0 ohms, 1/2W	10%	Axial lead; LS=12.5mm	Ohmite, Dale	TBD	Yes	
R4A, R4B, R4C, R4D	4	Resistor, 1/4W SMD	1M, 1/4W	1%	SMD 1206	AVX, Vishay, Dale	TBD		
R1A, R1B, R1C	3	Resistor, 1/4W SMD	2.2M, 1/4W	1%	SMD 1206	AVX, Vishay, Dale	TBD		
R9, R10	2	Resistor, 1/4W SMD	1K	1%	SMD 1206	AVX, Vishay, Dale	TBD	Yes	
R3A, B, C,	4	Resistor, 1/4W SMD	390K	1%	SMD 1206	AVX, Vishay, Dale	TBD		
R5, R6	2	Resistor, 1/4W SMD	10 ohms	1%	SMD 1206	AVX, Vishay, Dale	TBD	Yes	
R11	1	Resistor, 1/4W SMD	240 ohms	1%	SMD 1206	AVX, Vishay, Dale	TBD	Yes	
R7,12,13	3	Resistor, 1/4W SMD	10K	1%	SMD 1206	AVX, Vishay, Dale	TBD	Yes	
R14	1	Resistor, 1/4W SMD	27K	1%	SMD 1206	AVX, Vishay, Dale	TBD	Yes	
R15	1	Resistor, 1/4W SMD	15K	1%	SMD 1206	AVX, Vishay, Dale	TBD	Yes	
R16, R17	2	Resistor, 1/4W SMD	3.3K	1%	SMD 1206	AVX, Vishay, Dale	TBD		
Jmp1	1	Resistor, 1/4W SMD	Zero ohm	1%	SMD 1206	AVX, Vishay, Dale	TBD		
TVS1	1	TVS (optional)	TBD		Axial Lead - LS= 12.5mm	ON Semi	TBD		
F1	1	Fuse, S505 style (ceramic)	1.6A, 1500Vac		Axial, LS-26mm, Dia=6mm	Bussmann	BK/S505-1.6R	Yes	
L1A/B	1	Inductor (EMI choke)	820 uH, 500 mA		Dia = 10mm, LS = 5mm	Coilcraft	RFB0810-1821L	Yes	
T1 (12Vout)	1	Transformer - E20/10/6 core	14 pin bobbin		See Mag Drawing	Würth Magnetics	750313473 Rev 01	Yes	
J1	1	Screw Terminal			LS = 0.2"	DigiKey	# 281-1435-ND	Yes	

References:

- ON Semiconductor NCP1251 Data Sheet: http://www.onsemi.com/pub_link/Collateral/NCP1251-D.PDF
- ON Semiconductor Design Note DN05017: http://www.onsemi.com/pub_link/Collateral/DN05017-D.PDF
- ON Semiconductor Design Note DN05012: http://www.onsemi.com/pub_link/Collateral/DN05012-D.PDF
- ON Semiconductor Design Note DN05028: http://www.onsemi.com/pub_link/Collateral/DN05028-D.PDF
- ON Semiconductor Design Note DN05029: http://www.onsemi.com/pub_link/Collateral/DN05029-D.PDF
- ON Semiconductor Design Note DN05033: http://www.onsemi.com/pub_link/Collateral/DN05033-D.PDF

© 2012 ON Semiconductor.

Disclaimer: ON Semiconductor is providing this design note "AS IS" and does not assume any liability arising from its use; nor does ON Semiconductor convey any license to its or any third party's intellectual property rights. This document is provided only to assist customers in evaluation of the referenced circuit implementation and the recipient assumes all liability and risk associated with its use, including, but not limited to, compliance with all regulatory standards. ON Semiconductor may change any of its products at any time, without notice.

Design note created by Frank Cathell, e-mail: f.cathell@onsemi.com