

Self Protected Very Low I_q High Side Driver with Analog Current Sense

NCV84160

The NCV84160 is a fully protected single channel high side driver that can be used to switch a wide variety of loads, such as bulbs, solenoids, and other actuators. The device incorporates advanced protection features such as active inrush current management, over-temperature shutdown with automatic restart and an overvoltage active clamp. A dedicated Current Sense pin provides precision analog current monitoring of the output as well as fault indication of short to V_D , short circuit to ground and ON and OFF state open load detection. An active high Current Sense Disable pin allows all diagnostic and current sense features to be disabled.

Features

- Short Circuit Protection with Inrush Current Management
- CMOS (3 V / 5 V) Compatible Control Input
- Very Low Standby Current
- Very Low Current Sense Leakage
- Proportional Load Current Sense
- Current Sense Disable
- Off State Open Load Detection
- Output Short to V_D Detection
- Overload and Short to Ground Indication
- Thermal Shutdown with Automatic Restart
- Undervoltage Shutdown
- Integrated Clamp for Inductive Switching
- Loss of Ground and Loss of V_D Protection
- ESD Protection
- Reverse Battery Protection
- AEC-Q100 Qualified
- This is a Pb-Free Device

Typical Applications

- Switch a Variety of Resistive, Inductive and Capacitive Loads
- Can Replace Electromechanical Relays and Discrete Circuits
- Automotive / Industrial

FEATURE SUMMARY

Max Supply Voltage	V_D	41	V
Operating Voltage Range	V_D	4.5 to 28	V
R_{DSon} (max) $T_J = 25^\circ\text{C}$	R_{ON}	160	m Ω
Output Current Limit (typical)	I_{LIM}	12	A
OFF-state Supply Current (typical)	$I_{D(off)}$	0.01	μA



ON Semiconductor®

www.onsemi.com

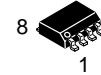

SOIC-8
CASE 751
STYLE 11

MARKING DIAGRAM

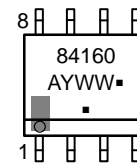

84160 = Specific Device Code
A = Assembly Location
Y = Year
WW = Work Week
▪ = Pb-Free Package

(Note: Microdot may be in either location)

PIN CONNECTIONS

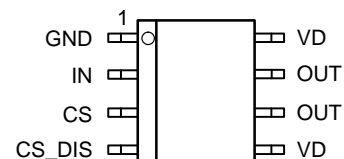

(Top View)

ORDERING INFORMATION

Device	Package	Shipping†
NCV84160DR2G	SOIC-8 (Pb-Free)	2500 / Tape & Reel

†For information on tape and reel specifications, including part orientation and tape sizes, please refer to our Tape and Reel Packaging Specification Brochure, BRD8011/D.

Block Diagram & Pin Configuration

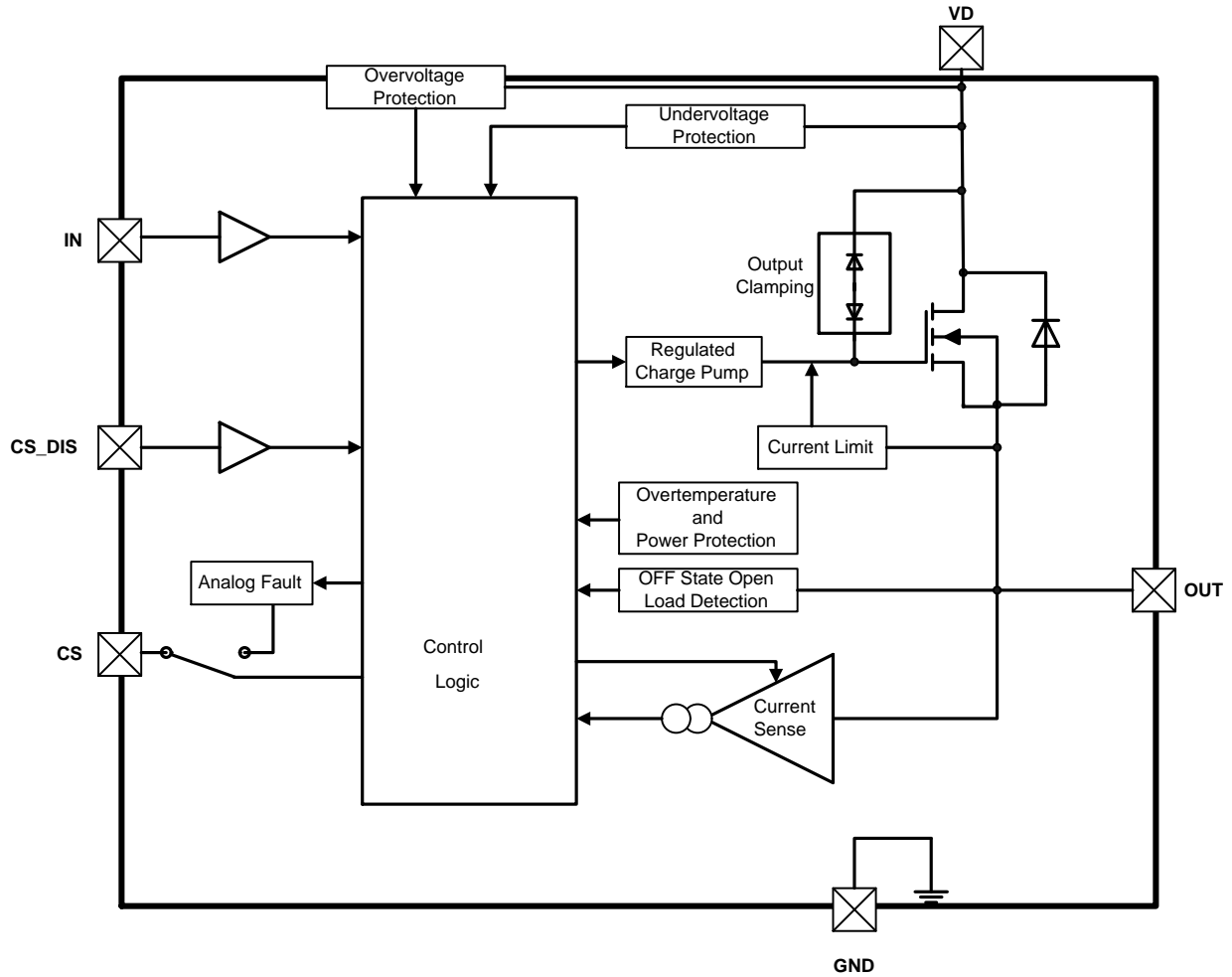

Figure 1. Block Diagram

Table 1. SO8 PACKAGE PIN DESCRIPTION

Pin #	Symbol	Description
1	GND	Ground
2	IN	Logic Level Input
3	CS	Analog Current Sense Output
4	CS_DIS	Active High Current Sense Disable
5	V _D	Supply Voltage
6	OUT	Output
7	OUT	Output
8	V _D	Supply Voltage

NCV84160

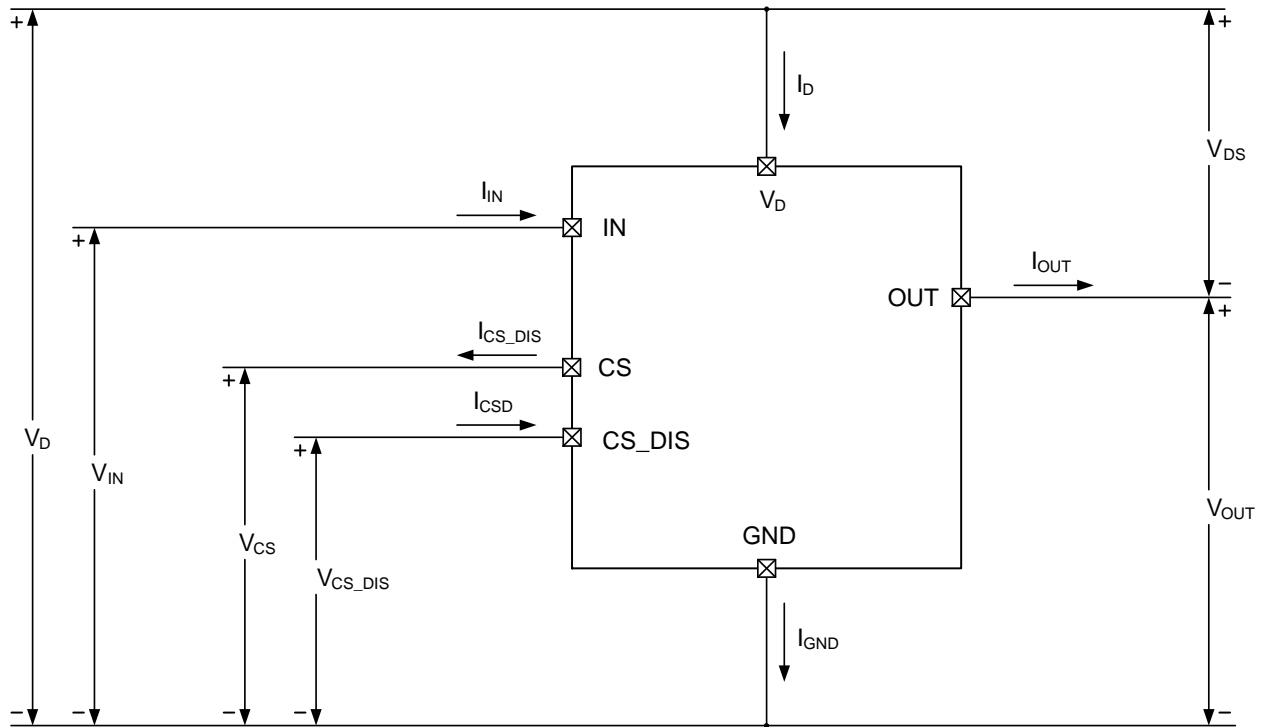

Figure 2. Voltage and Current Conventions

Table 2. Connection suggestions for unused and or unconnected pins

Connection	Input	Output	Current Sense	Current Sense Enable
Floating	X	X	Not Allowed	X
To Ground	Through 10 kΩ resistor	Not Allowed	Through 1 kΩ Resistor	Through 10 kΩ resistor

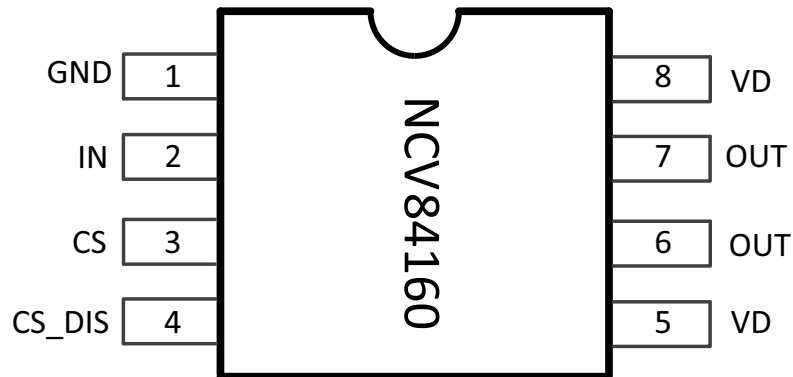

Figure 3. Pin Configuration (top view)

NCV84160

ELECTRICAL SPECIFICATIONS

Table 3. MAXIMUM RATINGS

Rating	Symbol	Value		Unit
		Min	Max	
DC Supply Voltage	V_D	-0.3	41	V
Peak Transient Input Voltage (Load Dump 46 V, $V_D = 14$ V, ISO16750-2: 2012 Test B)	V_{peak}		48	V
Input Voltage	V_{IN}	-10	10	V
Input Current	I_{IN}	-5	5	mA
Reverse Ground Pin Current	I_{GND}		-200	mA
Output Current (Note 2)	I_{OUT}	-6	Internally Limited	A
CS Current	I_{CS}		200	mA
CS Voltage	V_{CS}	V_D-41	V_D	V
CS_DIS Voltage	V_{CS_DIS}	-10	10	V
CS_DIS Current	I_{CS_DIS}	-5	5	mA
Power Dissipation $T_c = 25^\circ\text{C}$ (Note 4)	P_{tot}	1.49		W
Electrostatic Discharge (HBM Model 100 pF / 1500 Ω)	V_{ESD}			DC
Input		4		kV
Current Sense		3		kV
Current Sense Enable		4		kV
Output		3		kV
V_D		3		kV
Charge Device Model CDM-AEC-Q100-011		750		V
Single Pulse Inductive Load Switching Energy (Note 1) ($L = 8$ mH, $V_{bat} = 13.5$ V; $I_L = 2.8$ A, $T_{J_Start} = 150^\circ\text{C}$)	E_{AS}		42.85	mJ
Operating Junction Temperature	T_J	-40	+150	$^\circ\text{C}$
Storage Temperature	$T_{storage}$	-55	+150	$^\circ\text{C}$

Stresses exceeding those listed in the Maximum Ratings table may damage the device. If any of these limits are exceeded, device functionality should not be assumed, damage may occur and reliability may be affected.

1. Not subjected to production testing
2. Reverse Output current has to be limited by the load to stay within absolute maximum ratings and thermal performance.

Table 4. THERMAL RESISTANCE RATINGS

Parameter	Symbol	Max. Value	Units
Thermal Resistance			$^\circ\text{C}/\text{W}$
Junction-to-Lead	$R_{\theta JL}$	32	
Junction-to-Ambient (Note 3)	$R_{\theta JA}$	98	
Junction-to-Ambient (Note 4)	$R_{\theta JA}$	84	

3. Min. pad size, 1 oz. Cu with backside plane covered with 1 oz. Cu (backside plane not electrically connected).
4. 2 cm² pad size, 1 oz. Cu with backside plane covered with 1 oz. Cu (backside plane not electrically connected).

NCV84160

ELECTRICAL CHARACTERISTICS ($8 \leq V_D \leq 28$ V; $-40^\circ\text{C} < T_J < 150^\circ\text{C}$ unless otherwise specified)

Table 5. POWER

Rating	Symbol	Conditions	Value			Unit
			Min	Typ	Max	
Operating Supply Voltage	V_D		4.5	–	28	V
Undervoltage Shutdown	V_{UV}			3.5	4.5	V
Undervoltage Shutdown Hysteresis	V_{UV_HYST}			0.5		V
On Resistance	R_{ON}	$I_{OUT} = 1$ A, $T_J = 25^\circ\text{C}$			160	m Ω
		$I_{OUT} = 1$ A, $T_J = 150^\circ\text{C}$			320	
		$I_{OUT} = 1$ A, $V_D = 5$ V, $T_J = 25^\circ\text{C}$			210	
Supply Current (Note 5)	I_D	OFF-state: $V_D = 13$ V, $V_{IN} = V_{OUT} = 0$ V, $T_J = 25^\circ\text{C}$		0.01	0.5	μA
		ON-state: $V_D = 13$ V, $V_{IN} = 5$ V, $I_{OUT} = 0$ A		1.9	3.5	mA
Output Leakage Current	$I_{L(OFF)}$	$V_{IN} = V_{OUT} = 0$ V, $V_D = 13$ V, $T_J = 25^\circ\text{C}$			0.5	μA
		$V_{IN} = V_{OUT} = 0$ V, $V_D = 13$ V, $T_J = 125^\circ\text{C}$			0.5	

5. Includes PowerMOS leakage current.

Table 6. LOGIC INPUTS ($V_D = 13.5$ V; $-40^\circ\text{C} < T_J < 150^\circ\text{C}$)

Rating	Symbol	Conditions	Value			Unit
			Min	Typ	Max	
Input Voltage – Low	V_{IN_LOW}				0.9	V
Input Current – Low	I_{IN_LOW}	$V_{IN} = 0.9$ V	1			μA
Input Voltage – High	V_{IN_HIGH}		2.1			V
Input Current – High	I_{IN_HIGH}	$V_{IN} = 2.2$ V			10	μA
Input Hysteresis Voltage	V_{IN_HYST}		0.2			V
Input Clamp Voltage	V_{IN_CL}	$I_{IN} = 1$ mA	12	13	14	V
		$I_{IN} = -1$ mA	-14	-13	-12	
CS_DIS Voltage – Low	$V_{CS_DIS_LOW}$				0.9	V
CS_DIS Current – Low	$I_{CS_DIS_LOW}$	$V_{CS_DIS} = 0.9$ V	1			μA
CS_DIS Voltage – High	$V_{CS_DIS_HIGH}$		2.1			V
CS_DIS Current – High	$I_{CS_DIS_HIGH}$	$V_{CS_DIS} = 2.2$ V			10	μA
CS_DIS Hysteresis Voltage	$V_{CS_DIS_HYST}$		0.2			V
CS_DIS Clamp Voltage	$V_{CS_DIS_CL}$	$I_{CS_DIS} = 1$ mA	12	13	14	V
		$I_{CS_DIS} = -1$ mA	-14	-13	-12	

Product parametric performance is indicated in the Electrical Characteristics for the listed test conditions, unless otherwise noted. Product performance may not be indicated by the Electrical Characteristics if operated under different conditions.

NCV84160

Table 7. SWITCHING CHARACTERISTICS ($T_J = 25^\circ\text{C}$)

Rating	Symbol	Conditions	Value			Unit
			Min	Typ	Max	
Turn-On Delay Time	t_{d_on}	to 10% V_{OUT} , $V_D = 13\text{ V}$, $R_L = 13\ \Omega$		10		μs
Turn-Off Delay Time	t_{d_off}	to 90% V_{OUT} , $V_D = 13\text{ V}$, $R_L = 13\ \Omega$		10		μs
Slew Rate On	dV_{OUT}/dt_{on}	10% to 80% V_{OUT} , $V_D = 13\text{ V}$, $R_L = 13\ \Omega$		0.7		$\text{V} / \mu\text{s}$
Slew Rate Off	dV_{OUT}/dt_{off}	90% to 10% V_{OUT} , $V_D = 13\text{ V}$, $R_L = 13\ \Omega$		0.7		$\text{V} / \mu\text{s}$
Turn-On Switching Loss (Note 6)	E_{on}	$V_D = 13\text{ V}$, $R_L = 13\ \Omega$		0.04		mJ
Turn-Off Switching Loss (Note 6)	E_{off}	$V_D = 13\text{ V}$, $R_L = 13\ \Omega$		0.04		mJ

6. Not subjected to production testing

Table 8. OUTPUT DIODE CHARACTERISTICS

Rating	Symbol	Conditions	Value			Unit
			Min	Typ	Max	
Forward Voltage	V_F	$I_{OUT} = -1\text{ A}$, $T_J = 150^\circ\text{C}$, $V_F = V_{OUT} - V_D$			0.7	V

Table 9. PROTECTION FUNCTIONS (Note 8)

Rating	Symbol	Conditions	Value			Unit
			Min	Typ	Max	
Temperature Shutdown (Note 7)	T_{SD}		150	175	200	$^\circ\text{C}$
Temperature Shutdown Hysteresis ($T_{SD} - T_R$) (Note 7)	T_{SD_HYST}			7		$^\circ\text{C}$
Reset Temperature (Note 7)	T_R		$T_{R_CS}+1$	$T_{R_CS}+5$		$^\circ\text{C}$
Thermal Reset of CS_FAULT (Note 7)	T_{R_CS}		135			$^\circ\text{C}$
DC Output Current Limit	I_{LIM_H}	$V_D = 13\text{ V}$	6	12	18	A
		$5\text{ V} < V_D < 28\text{ V}$			18	A
Short Circuit Current Limit during Thermal Cycling (Note 7)	I_{LIM_L}	$V_D = 13\text{ V}$ $T_R < T_J < T_{SD}$		6.5		A
Switch Off Output Clamp Voltage	V_{OUT_CLAMP}	$I_{OUT} = 1\text{ A}$, $V_{IN} = 0\text{ V}$, $L = 20\text{ mH}$	$V_D - 41$	$V_D - 45$	$V_D - 52$	V
Overvoltage Protection	V_{OV}	$V_{IN} = 0\text{ V}$, $I_D = 20\text{ mA}$	41	45	52	V
Output Voltage Drop Limitation	V_{DS_ON}	$I_{OUT} = 0.025\text{ A}$, $-40^\circ\text{C} \leq T_J \leq 150^\circ\text{C}$		25		mV

7. Not subjected to production testing.

8. To ensure long term reliability during overload or short circuit conditions, protection and related diagnostic signals must be used together with a fitting hardware & software strategy. If the device operates under abnormal conditions, this hardware & software solution must limit the duration and number of activation cycles.

Table 10. OPEN-LOAD DETECTION ($8 \leq V_D \leq 18\text{ V}$)

Rating	Symbol	Conditions	Value			Unit
			Min	Typ	Max	
Open-load Off-State Detection Threshold	V_{OL}	$V_{IN} = 0\text{ V}$	2	-	4	V
Open-load On-State Detection Threshold	I_{OL}	$V_{IN} = 5\text{ V}$, $I_{CS} = 5\ \mu\text{A}$	0.5		5	mA
Open-load Detection Delay at Turn-Off	$t_{d_OL_off}$		100		800	μs
Off-State Output Current	I_{LOFF1}	$V_{IN} = 0\text{ V}$, $V_{OUT} = V_{OL}$	-3		3	μA
Output rising edge to CS rising edge during open-load	t_{D_OL}	$V_{OUT} = 4\text{ V}$, $V_{IN} = 0\text{ V}$, $V_{CS} = 90\%$ of V_{CS_HIGH}			20	μs

NCV84160

Table 11. CURRENT SENSE CHARACTERISTICS ($8 \leq V_D \leq 18 \text{ V}$)

Rating	Symbol	Conditions	Value			Unit
			min	typ	max	
Current Sense Ratio	K_0	$I_{OUT} = 0.025 \text{ A}$, $V_{CS} = 0.5 \text{ V}$, $T_J = -40^\circ\text{C}$ to 150°C	260	490	760	I_{OUT} / I_{CS}
Current Sense Ratio	K_1	$I_{OUT} = 0.35 \text{ A}$, $V_{CS} = 0.5 \text{ V}$, $T_J = -40^\circ\text{C}$ to 150°C	310	465	620	
		$I_{OUT} = 0.35 \text{ A}$, $V_{CS} = 0.5 \text{ V}$, $T_J = 25^\circ\text{C}$ to 150°C	360	465	545	
Current Sense Ratio Drift (Note 9)	$\Delta K_1 / K_1$	$I_{OUT} = 0.35 \text{ A}$, $V_{CS} = 0.5 \text{ V}$, $T_J = -40^\circ\text{C}$ to 150°C	-11		11	%
Current Sense Ratio	K_2	$I_{OUT} = 0.5 \text{ A}$, $V_{CS} = 4 \text{ V}$, $T_J = -40^\circ\text{C}$ to 150°C	350	455	570	
		$I_{OUT} = 0.5 \text{ A}$, $V_{CS} = 4 \text{ V}$, $T_J = 25^\circ\text{C}$ to 150°C	380	455	530	
Current Sense Ratio Drift (Note 9)	$\Delta K_2 / K_2$	$I_{OUT} = 0.5 \text{ A}$, $T_J = -40^\circ\text{C}$ to 150°C	-8		8	%
Current Sense Ratio	K_3	$I_{OUT} = 1.5 \text{ A}$, $V_{CS} = 4 \text{ V}$, $T_J = -40^\circ\text{C}$ to 150°C	405	455	505	
		$I_{OUT} = 1.5 \text{ A}$, $V_{CS} = 4 \text{ V}$, $T_J = 25^\circ\text{C}$ to 150°C	415	455	495	
Current Sense Ratio Drift (Note 9)	$\Delta K_3 / K_3$	$I_{OUT} = 1.5 \text{ A}$, $T_J = -40^\circ\text{C}$ to 150°C	-4		4	%
Current Sense Leakage Current	$CS_{I_{lk}}$	$I_{OUT} = 0 \text{ A}$, $V_{CS} = 0 \text{ V}$ $V_{CS_DIS} = 5 \text{ V}$, $V_{IN} = 0 \text{ V}$ $T_J = -40^\circ\text{C}$ to 150°C			1	μA
		$I_{OUT} = 0 \text{ A}$, $V_{CS} = 0 \text{ V}$ $V_{CS_DIS} = 0 \text{ V}$, $V_{IN} = 5 \text{ V}$ $T_J = -40^\circ\text{C}$ to 150°C			2	
		$I_{OUT} = 1 \text{ A}$, $V_{CS} = 0 \text{ V}$ $V_{CS_DIS} = 5 \text{ V}$, $V_{IN} = 5 \text{ V}$ $T_J = -40^\circ\text{C}$ to 150°C			1	
CS Max Voltage	CS_{Max}	$R_{CS} = 10 \text{ k}\Omega$, $I_{OUT} = 1 \text{ A}$	5			V
Current Sense Voltage in Fault Condition (Note 10)	V_{CS_FAULT}	$V_D = 13 \text{ V}$, $R_{CS} = 3.9 \text{ k}\Omega$		8		V
Current Sense Current in Fault Condition (Note 10)	I_{CS_FAULT}	$V_D = 13 \text{ V}$, $V_{CS} = 5 \text{ V}$		15		mA
CS_DIS Low to CS High Delay Time	t_{CS_HIGH1}	$V_{CS} < 4 \text{ V}$, $0.025 \text{ A} < I_{OUT} < 1.5 \text{ A}$ $I_{CS} = 90\%$ of $I_{CS} \text{ Max}$		40	100	μs
CS_DIS High to CS Low Delay Time	t_{CS_LOW1}	$V_{CS} < 4 \text{ V}$, $0.025 \text{ A} < I_{OUT} < 1.5 \text{ A}$ $I_{CS} = 10\%$ of $I_{CS} \text{ Max}$		5	20	μs
V_{IN} High to CS High Delay Time	t_{CS_HIGH2}	$V_{CS} < 4 \text{ V}$, $0.025 \text{ A} < I_{OUT} < 1.5 \text{ A}$ $I_{CS} = 90\%$ of $I_{CS} \text{ Max}$		30	160	μs
V_{IN} Low to CS Low Delay Time	t_{CS_LOW2}	$V_{CS} < 4 \text{ V}$, $0.025 \text{ A} < I_{OUT} < 1.5 \text{ A}$ $I_{CS} = 10\%$ of $I_{CS} \text{ Max}$		80	250	μs
Delay Time I_D Rising Edge to Rising Edge of CS	Δt_{CS_HIGH2}	$V_{CS} < 4 \text{ V}$, $I_{CS} = 90\%$ of $I_{CS} \text{ Max}$, $I_{OUT} = 90\%$ of I_{OUTmax} , $I_{OUTmax} = 1.5 \text{ A}$			110	μs

9. Not subjected to production testing.

10. The following fault conditions are: Overtemperature, Power Limitation, and OFF State Open-Load Detection.

NCV84160

Table 12. TRUTH TABLE

Conditions	Input	Output	CS ($V_{CS_DIS} = 0\text{ V}$) (Note 11)
Normal Operation	L H	L H	0 $I_{CS} = I_{OUT}/K_{NOMINAL}$
Over-temperature	L H	L L	0 V_{CS_FAULT}
Under-voltage	L H	L L	0 0
Overload	H H	H (no active current mgmt) Cycling (active current mgmt)	$I_{CS} = I_{OUT}/K_{NOMINAL}$ V_{CS_FAULT}
Short circuit to Ground	L H	L L	0 V_{CS_FAULT}
OFF State Open-Load	L	H	V_{CS_FAULT}

11. If the V_{CS_DIS} is high, the Current Sense output is at a high impedance, its potential depends on leakage currents and external circuitry.

ELECTRICAL CHARACTERISTICS WAVEFORMS AND GRAPHS

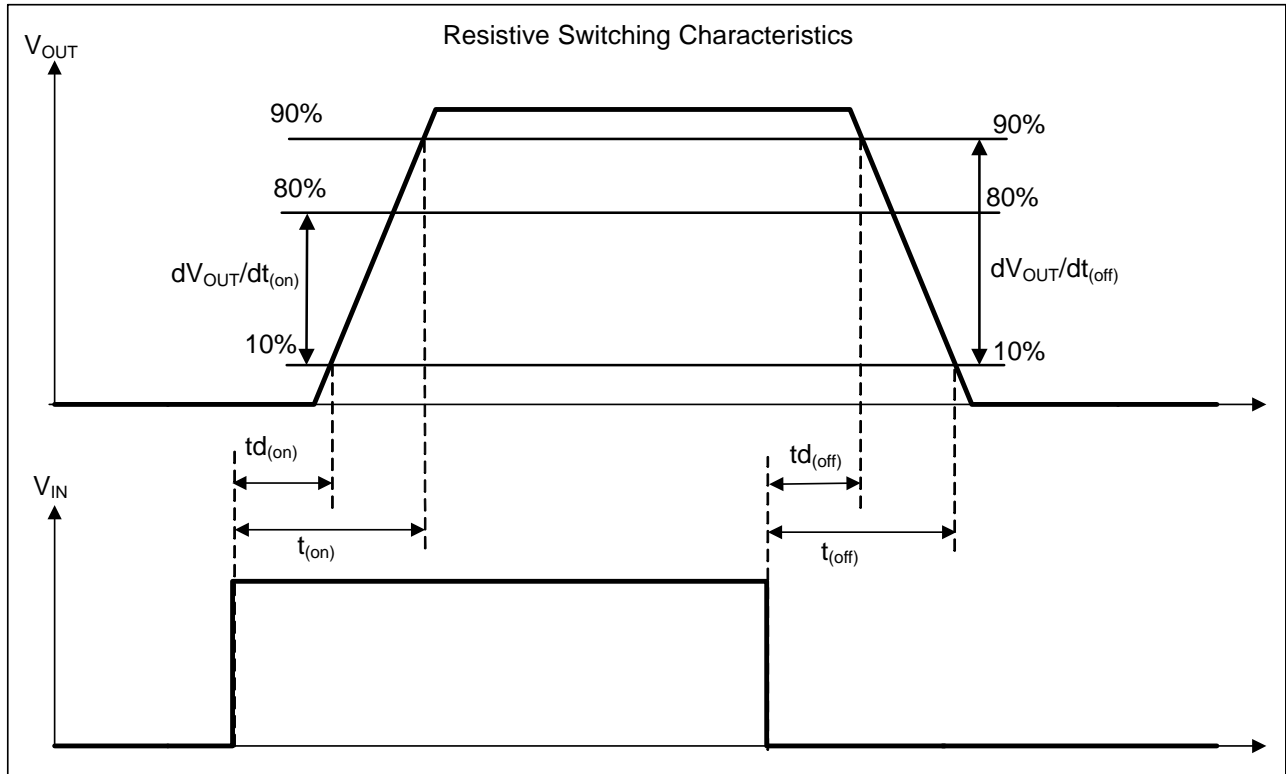

Figure 4. Switching Characteristics

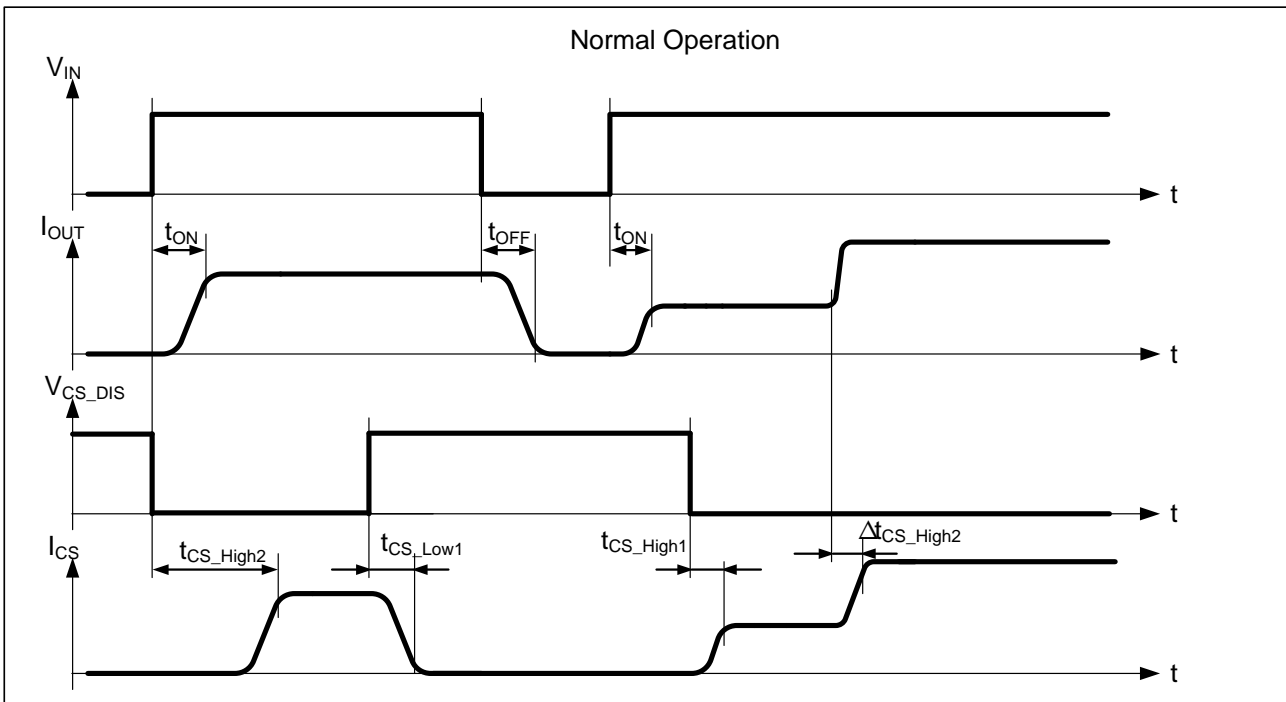

Figure 5. Normal Operation with Current Sense Timing Characteristics

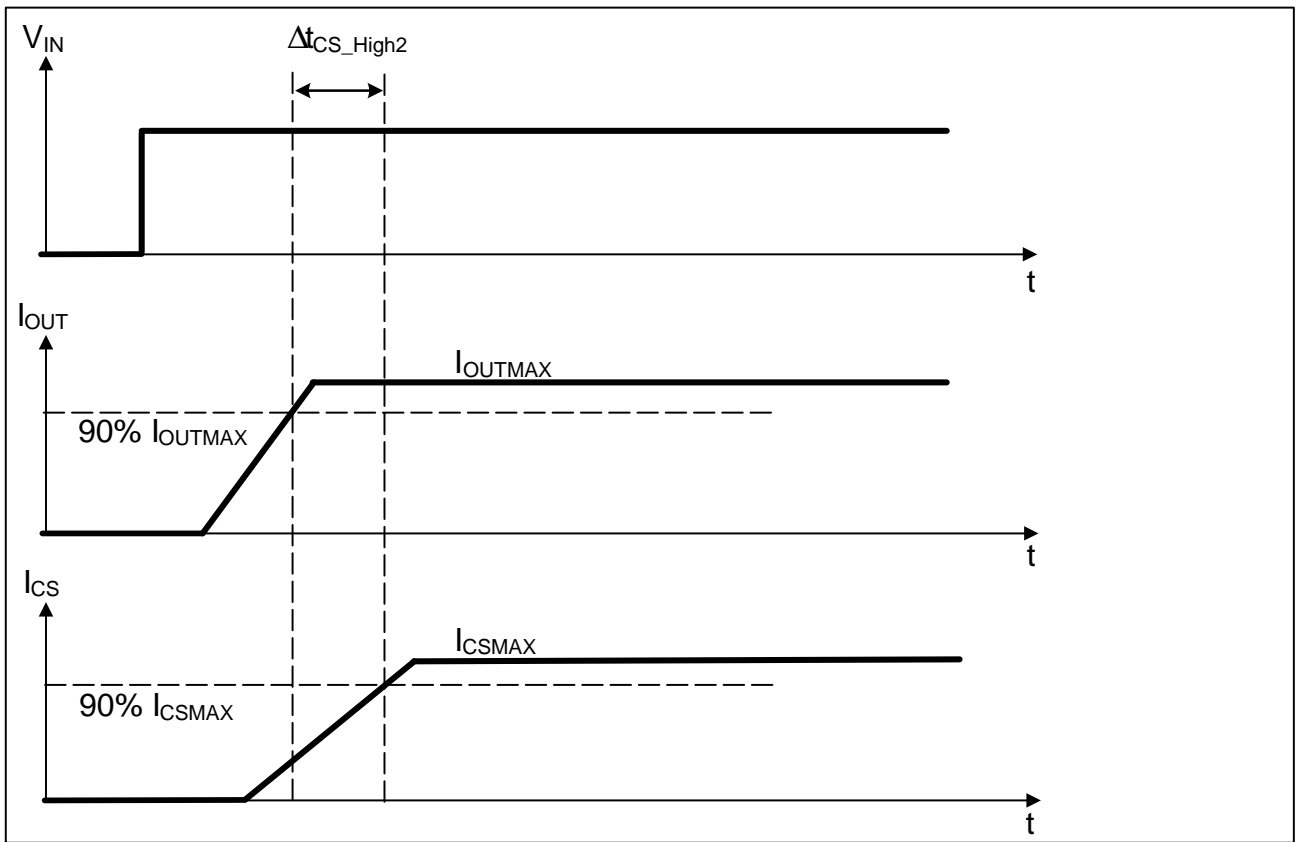

Figure 6. Delay Response from Rising Edge of I_{OUT} and Rising Edge of CS (for CS_EN = 5V)

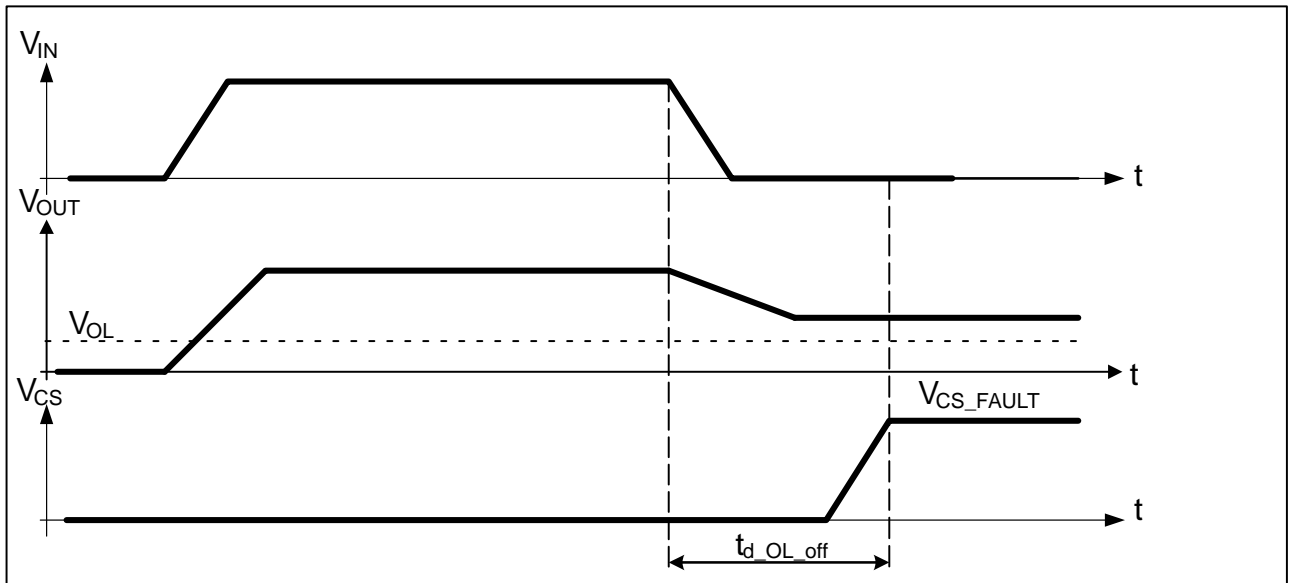

Figure 7. OFF-State Open-Load Flag Delay Timing

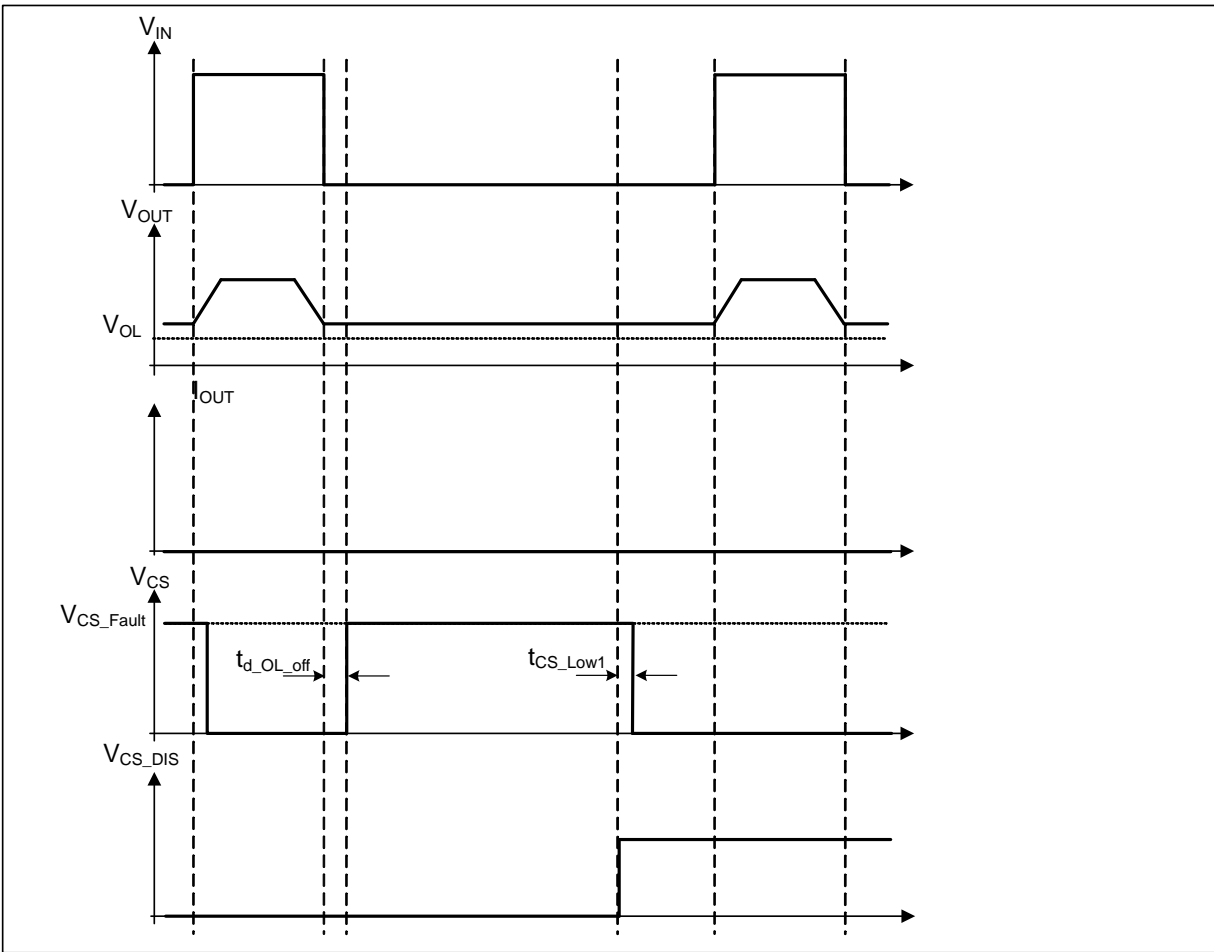

Figure 8. Off-State Open-Load with added external components

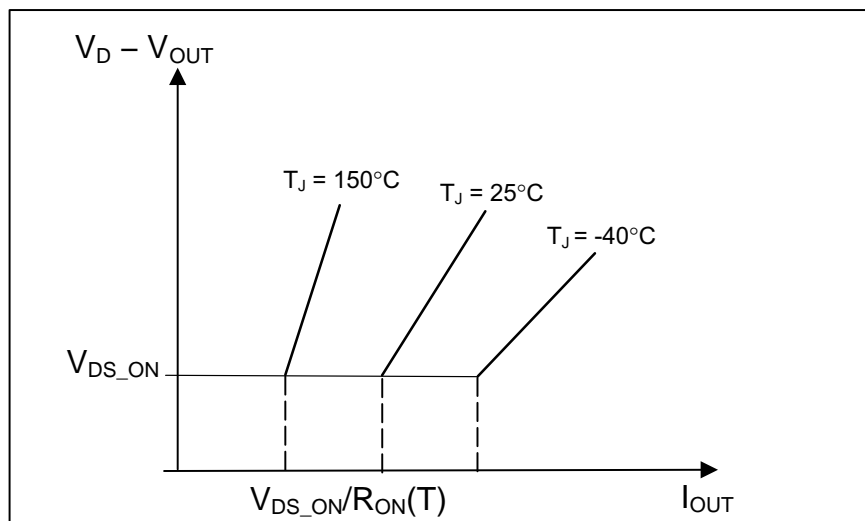

Figure 9. Voltage Drop Limitation for V_{DS_ON}

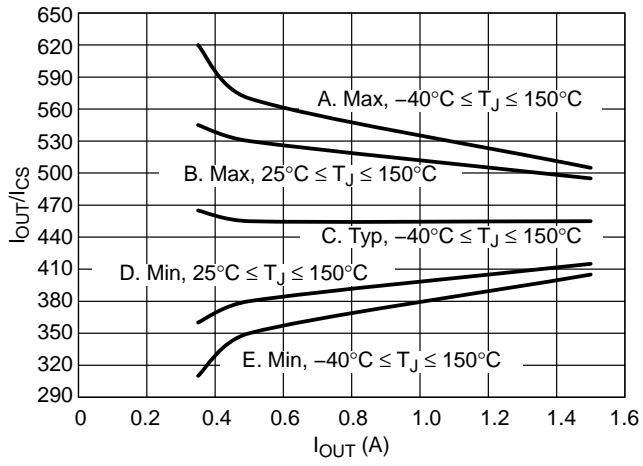

Figure 10. I_{OUT}/I_{Sense} vs I_{OUT}

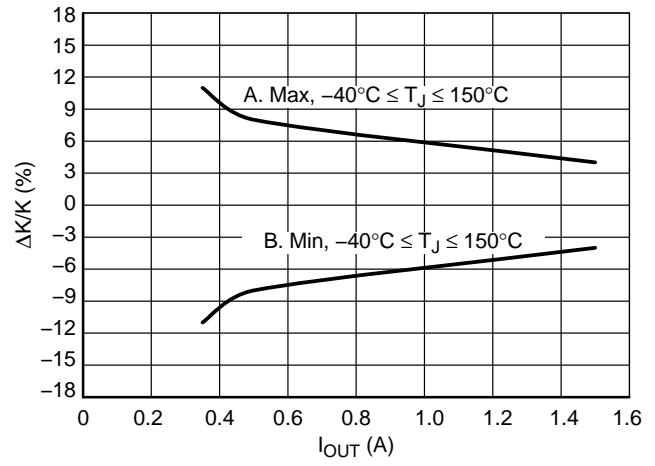

Figure 11. Maximum Current Sense Ratio Drift vs Load Current

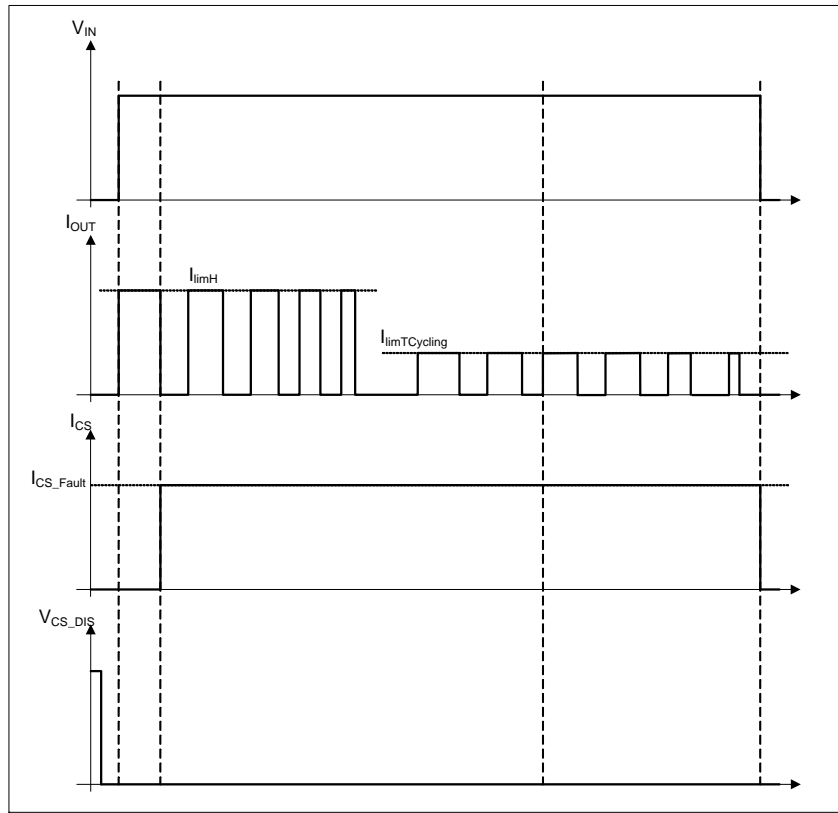

Figure 12. Short to GND or Overload

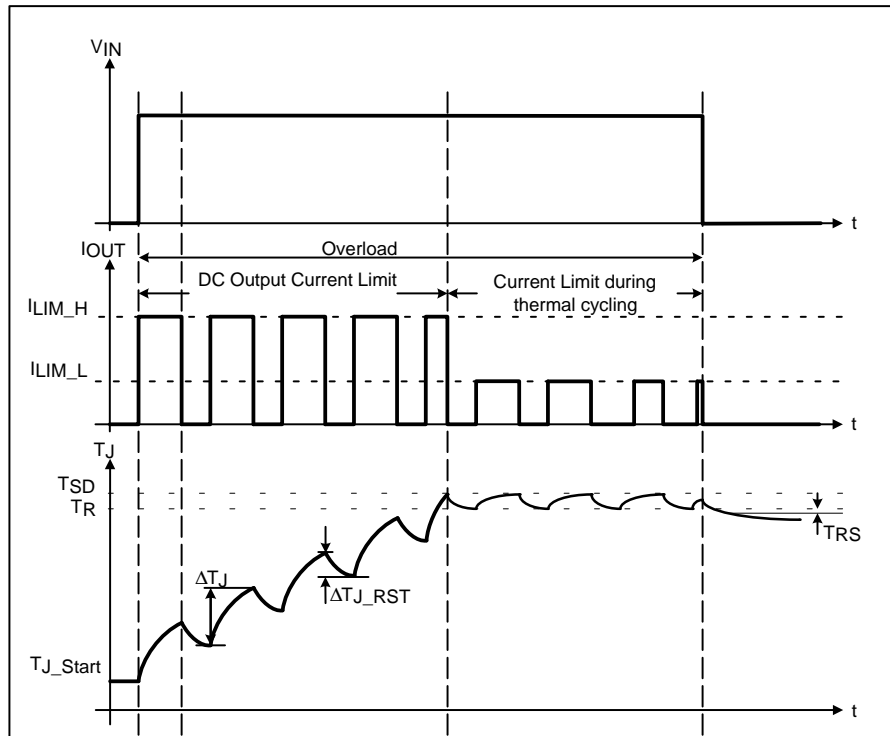

Figure 13. How T_J Progresses During Short to GND or Overload

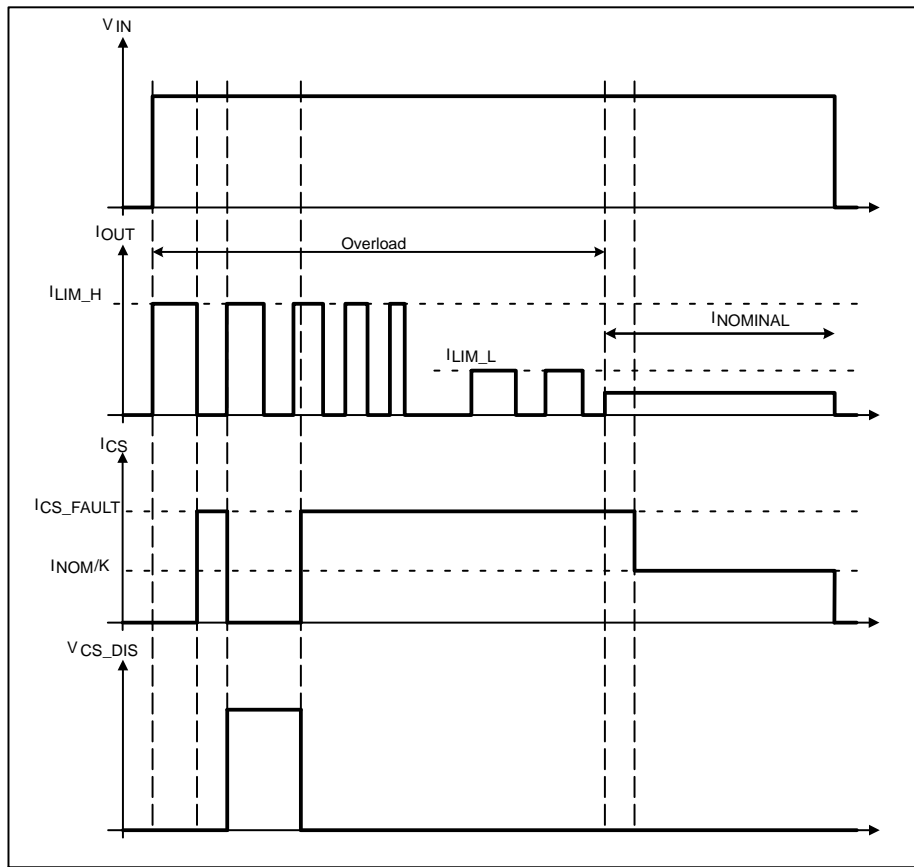

Figure 14. Discontinuous Overload or Short to GND

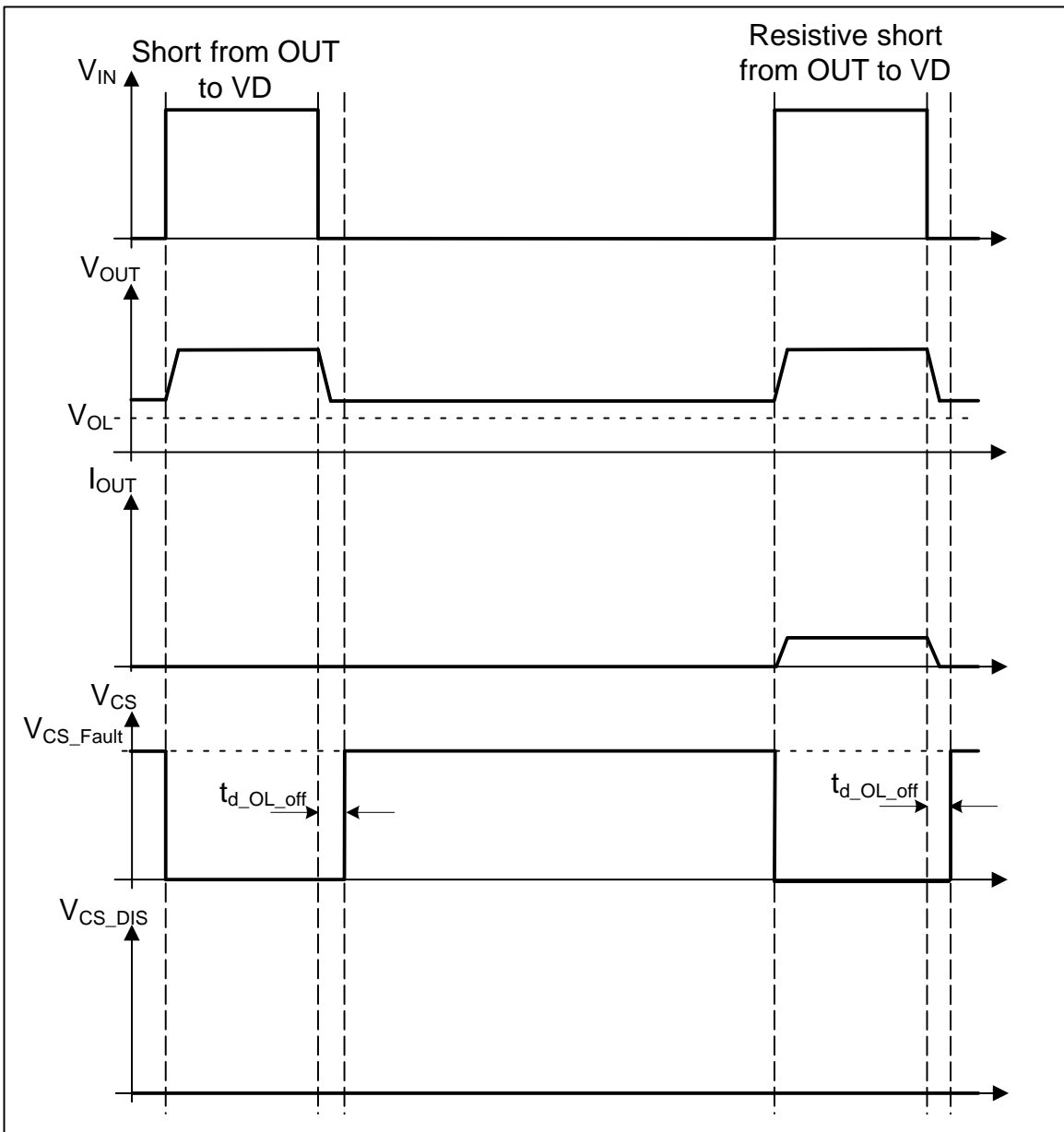

Figure 15. Short Circuit from OUT to VD

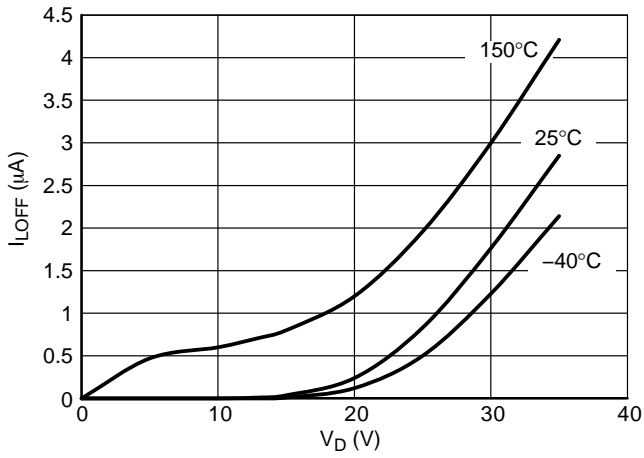

Figure 16. Output Leakage Current vs. VD Voltage & Temperature, VOUT = 0 V

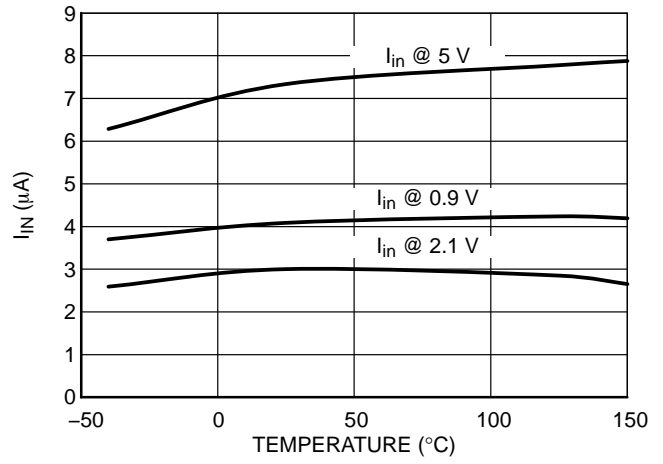

Figure 17. Input Current vs. Temperature

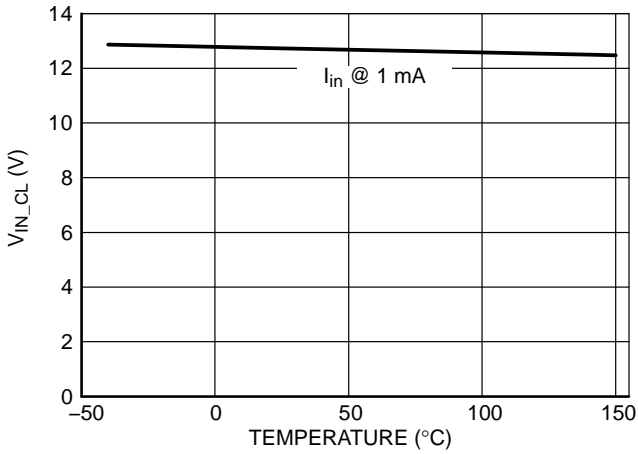

Figure 18. Input Clamp Voltage (Positive) vs. Temperature

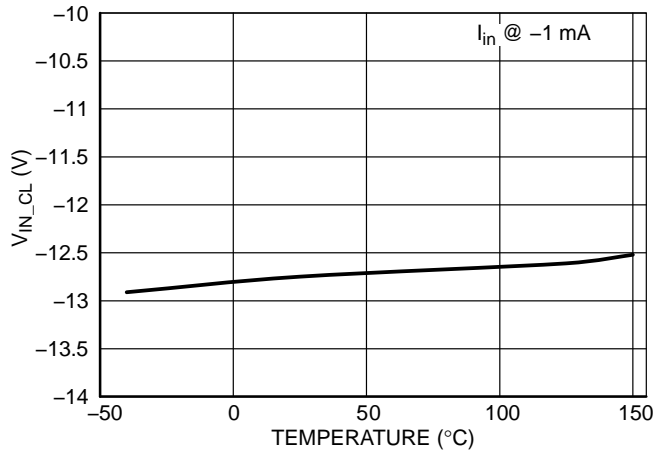

Figure 19. Input Clamp Voltage (Negative) vs. Temperature

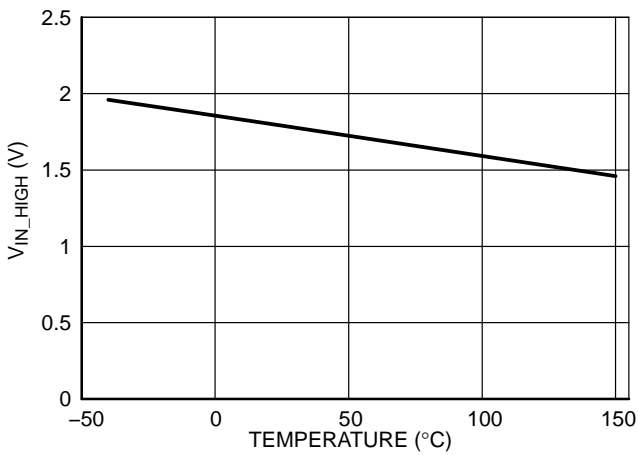

Figure 20. V_{IN} Threshold High vs. Temperature

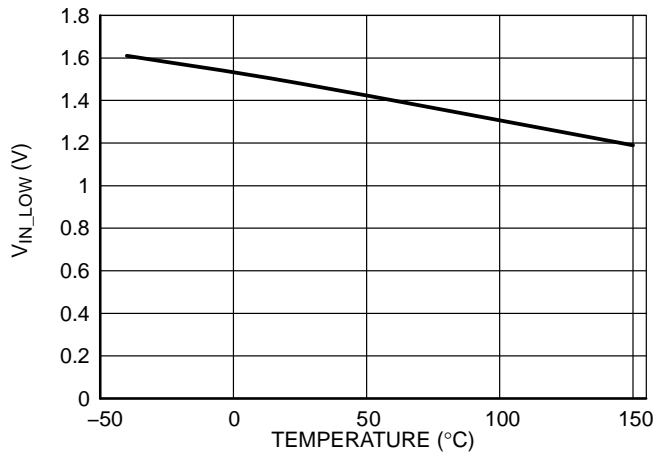

Figure 21. V_{IN} Threshold Low vs. Temperature

NCV84160

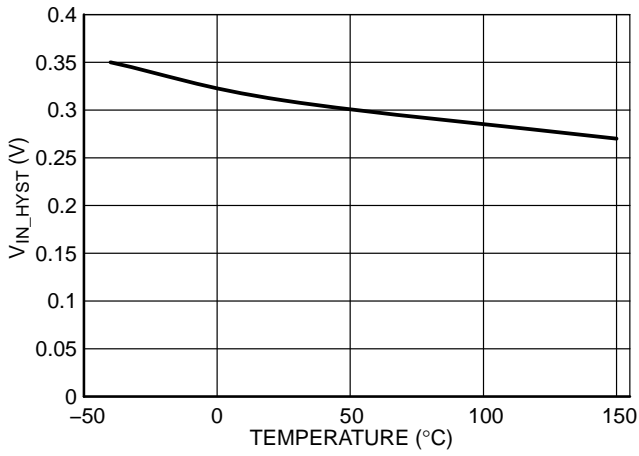

Figure 22. Hysteresis Input Voltage vs. Temperature

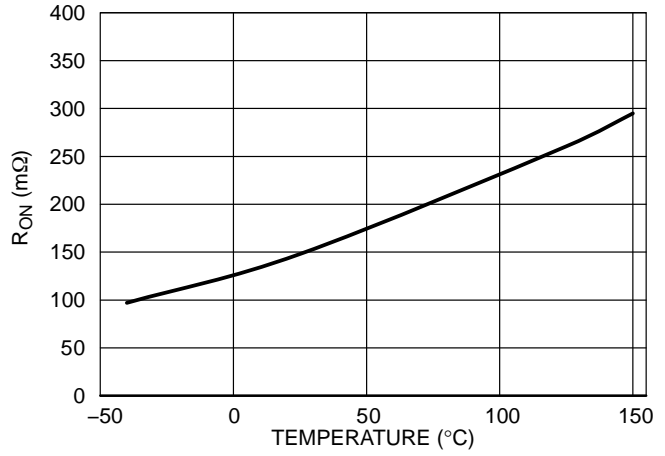

Figure 23. R_{ON} vs. Temperature

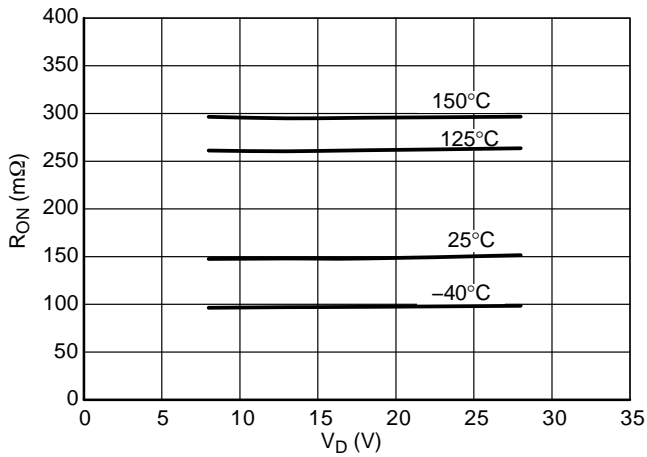

Figure 24. R_{ON} vs. Temperature & V_D Voltage

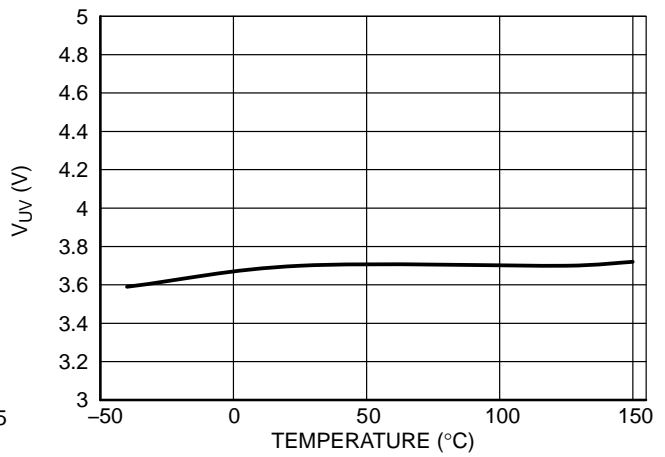

Figure 25. Undervoltage Shutdown vs. Temperature

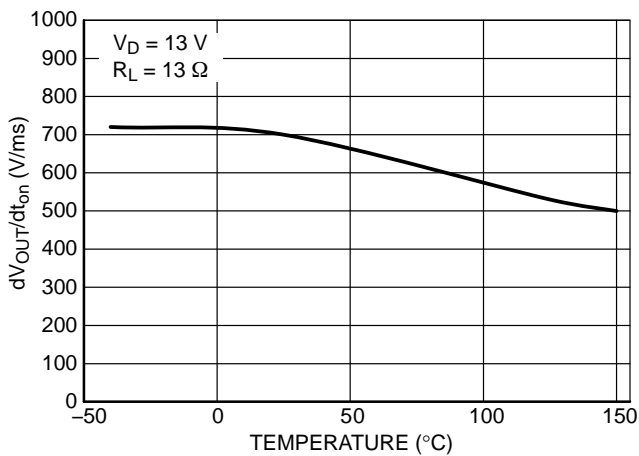

Figure 26. Slew Rate On vs. Temperature

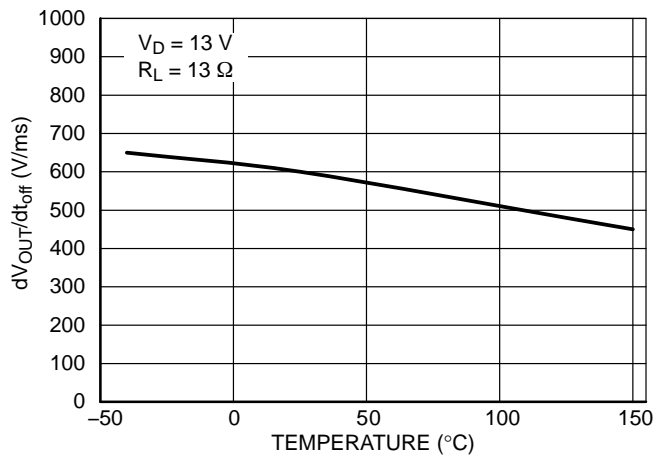

Figure 27. Slew Rate Off vs. Temperature

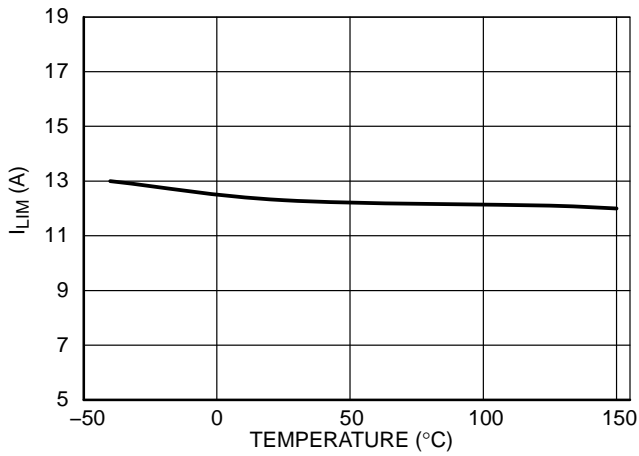

Figure 28. Current Limit vs. Temperature, $V_D = 13.5\text{ V}$

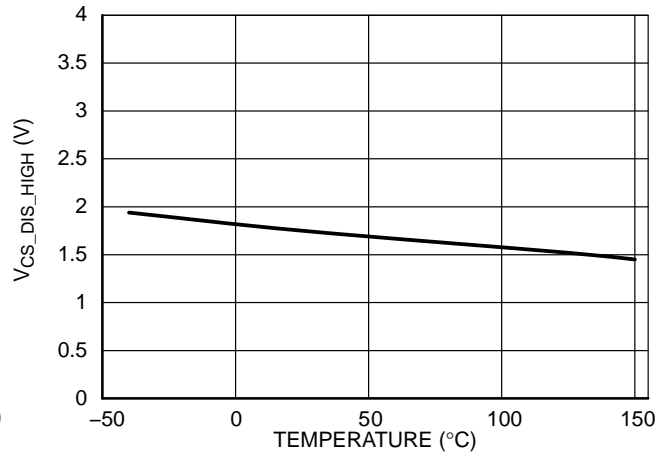

Figure 29. CS_DIS Threshold High vs. Temperature

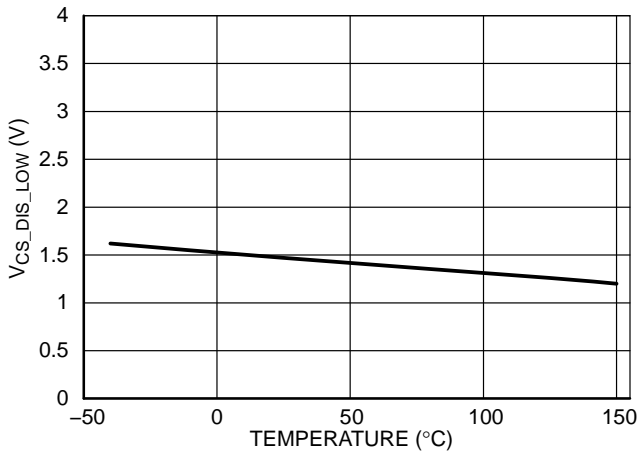

Figure 30. CS_DIS Threshold Low vs. Temperature

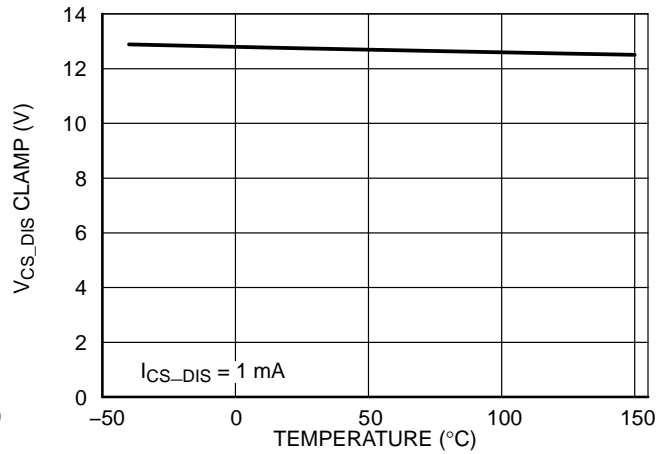

Figure 31. CS_DIS Clamp Voltage (Positive) vs. Temperature

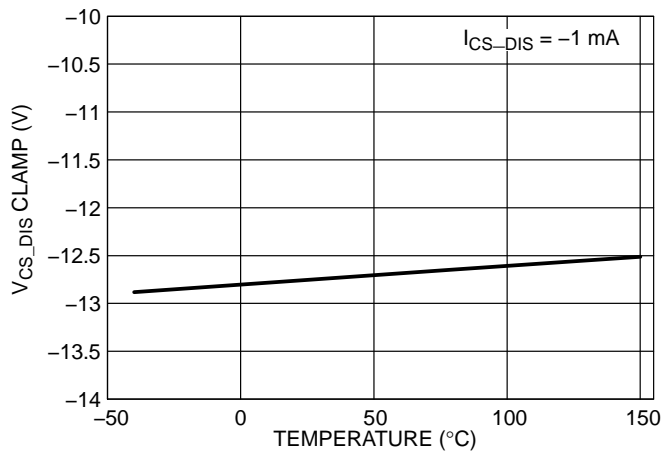

Figure 32. CS_DIS Clamp Voltage (Negative) vs. Temperature

NCV84160

ISO 7637-2: 2011(E) PULSE TEST RESULTS

ISO 7637-2:2011 Test Pulse	Test Severity Levels		Delays and Impedance	# of Pulses or Test Time	Pulse / Burst rep. time
	III	IV			
1	-112	-150	2 ms, 10 Ω	500 pulses	0.5 s
2a	55	112	0.05 ms, 2 Ω	500 pulses	0.5 s
3a	-165	-220	0.1 μ s, 50 Ω	1 h	100 ms
3b	112	150	0.1 μ s, 50 Ω	1 h	100 ms
ISO 7637-2:2011 Test Pulse	Test Results				
	III	IV			
1		A			
2a	A	E			
3a		A			
3b		A			
Class	Functional Status				
A	All functions of a device perform as designed during and after exposure to disturbance.				
B	All functions of a device perform as designed during exposure. However, one or more of them can go beyond specified tolerance. All functions return automatically to within normal limits after exposure is removed. Memory functions shall remain class A.				
C	One or more functions of a device do not perform as designed during exposure but return automatically to normal operation after exposure is removed.				
D	One or more functions of a device do not perform as designed during exposure and do not return to normal operation until exposure is removed and the device is reset by simple "operator/use" action.				
E	One or more functions of a device do not perform as designed during and after exposure and cannot be returned to proper operation without replacing the device.				

Application Information

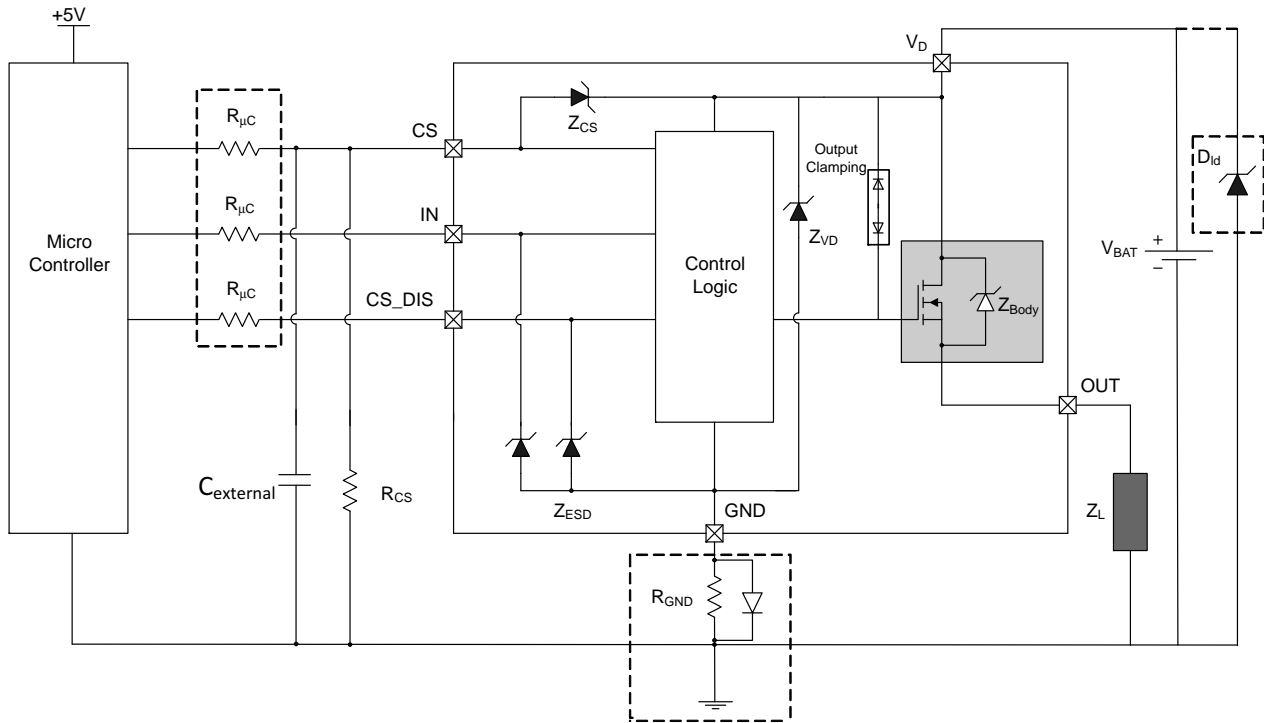

Figure 33. Application Schematic

Loss of Ground Protection

When device or ECU ground connection is lost and load is still connected to ground, the device will turn the output OFF. In loss of ground state, the output stage is held OFF independent of the state of the input. Input resistors are recommended between the device and microcontroller.

Reverse Battery Protection

Solution 1: Resistor in the GND line only (no parallel Diode)

The following calculations are true for any type of load.

In the case for no diode in parallel with R_{GND}, the calculations below explain how to size the resistor.

Consider the following parameters: -I_{GND} Maximum = 200 mA for up to -V_D = 32 V.

Where -I_{GND} is the DC reverse current through the GND pin and -V_D is the DC reverse battery voltage.

$$-I_{GND} = \frac{-V_D}{R_{GND}} \quad (\text{eq. 1})$$

Since this resistor can be used amongst multiple High-Side devices, please take note the sum of the maximum active GND currents (I_{GND(On)max}) for each device when sizing the resistor. Please note that if the microprocessor GND is not shared by the device GND, then R_{GND} produces a shift of (I_{GND(On)max} * R_{GND}) in the input thresholds and CS output values. If the calculated power dissipation leads to too large of a resistor size or several devices have to share the same resistor, please look at the second solution for Reverse Battery Protection. Refer to the figure below for selecting the proper R_{GND}.

NCV84160 Reverse Battery Considerations
 Normal Operation VIN = 5 V, Reverse Battery = 32 V

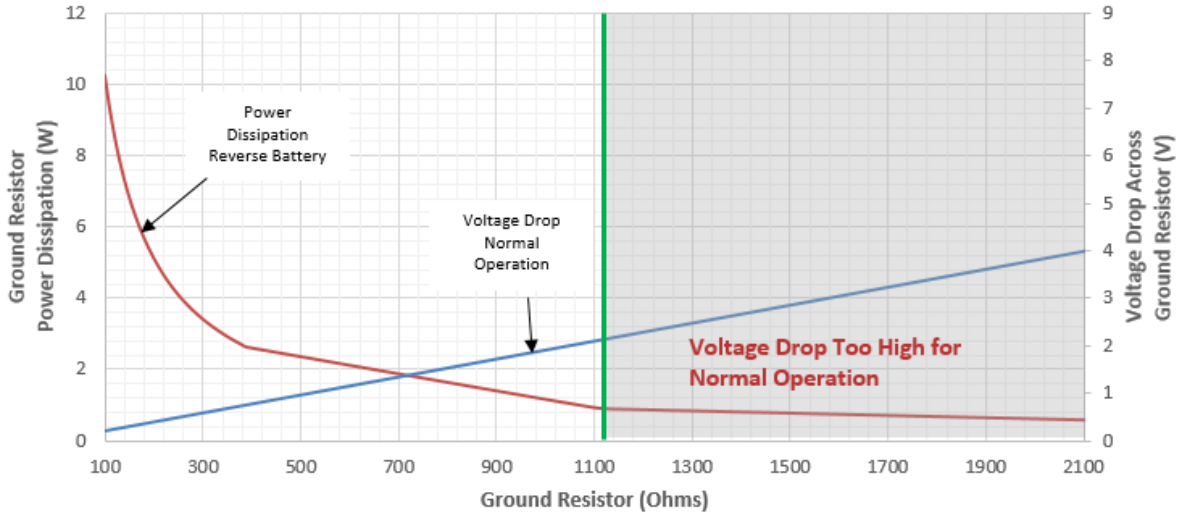

Figure 34. Reverse Battery R_{GND} Considerations

Solution 2: Diode (DGND) in parallel with R_{GND} in the ground line.

A resistor value of R_{GND} = 1 kOhm should be selected and placed in parallel to D_{GND} if the device drives an inductive load. The diode (D_{GND}) provides a ~600–700 mV shift in the input threshold and current sense values if the micro controller ground is not common to the device ground. This shift will not vary even in the case of multiple high-side devices using the same resistor/diode network.

Undervoltage Protection

The device has two under-voltage threshold levels, V_{D_MIN} and V_{UV}. Switching function (ON/OFF) requires supply voltage to be at least V_{D_MIN}. The device features a lower supply threshold V_{UV}, above which the output can remain in ON state. While all protection functions are guaranteed when the switch is ON, diagnostic functions are operational only within nominal supply voltage range V_D.

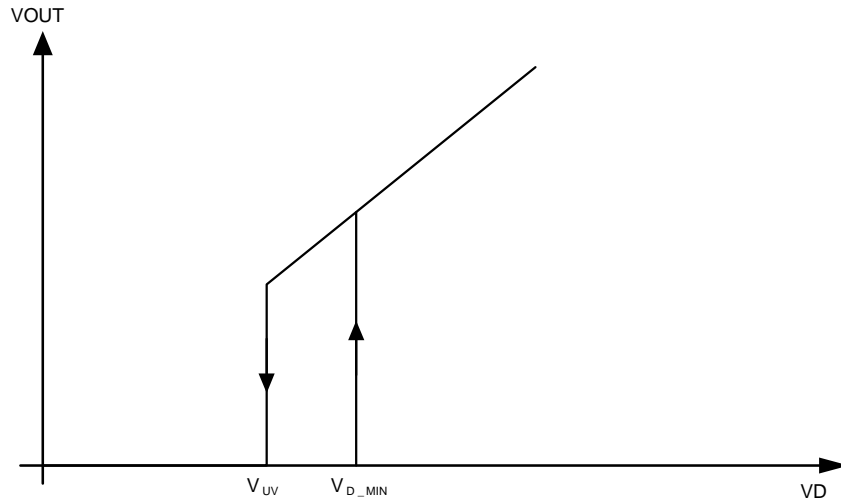

Figure 35. Undervoltage Behavior

Overvoltage Protection

The NCV84160 has two Zener diodes ZV_D and ZCS , which provide integrated overvoltage protection. ZV_D protects the logic block by clamping the voltage between supply pin V_D and ground pin GND to VZV_D . ZCS limits voltage at current sense pin CS to $V_D - VZCS$. The output power MOSFET's output clamping diodes provide protection by clamping the voltage across the MOSFET (between V_D pin and OUT pin) to V_{CLAMP} . During overvoltage protection, current flowing through ZV_D , ZCS and the output clamp must be limited. Load impedance Z_L limits the current in the body diode Z_{Body} . In order to limit the current in ZV_D a resistor, R_{GND} ($150\ \Omega$), is required in the GND path. External resistors R_{CS} and R_{SENSE} limit the current flowing through ZCS and out of the CS pin into the micro-controller I/O pin. With R_{GND} , the GND pin voltage is elevated to $V_D - VZV_D$ when the supply voltage V_D rises above VZV_D . ESD diodes $ZESD$ pull up the voltage at logic pins IN , CS_Dis close to the GND pin voltage $V_D - VZV_D$. External resistors R_{IN} , and R_{CS_DIS} are required to limit the current flowing out of the logic pins into the micro-controller I/O pins. During overvoltage exposure, the device transitions into a self-protection state, with automatic recovery after the supply voltage comes back to the normal operating range. The specified parameters as well as short circuit robustness and energy capability cannot be guaranteed during overvoltage exposure.

Overload Protection

Current limitation as well as over-temperature shutdown mechanisms are integrated into the NCV84160 to provide protection from overload conditions such as bulb inrush or short to ground.

Current Limitation

In case of overload, the NCV84160 limits the current in the output power MOSFET to a safe value. Due to high power dissipation during current limitation, the device's junction temperature increases rapidly. In order to protect the device, the output driver is shut down by one of the two over-temperature protection mechanisms. The output current limitation level is dependent on the drain-to-source voltage of the power MOSFET. If the input remains active during the shutdown, the output power MOSFET will automatically be re-activated after a minimum OFF time or when the junction temperature returns to a safe level.

Output Clamping with Inductive Load Switch Off:

The output voltage V_{OUT} drops below GND potential when switching off inductive loads. This is because the inductance develops a negative voltage across the load in response to a decaying current. The integrated clamp of the device clamps the negative output voltage to a certain level relative to the supply voltage V_{BAT} . During output clamping with inductive load switch off, the energy stored in the inductance is rapidly dissipated in the device resulting in high power dissipation. This is a stressful condition for the device and the maximum energy allowed for a given load inductance should not be exceeded in any application.

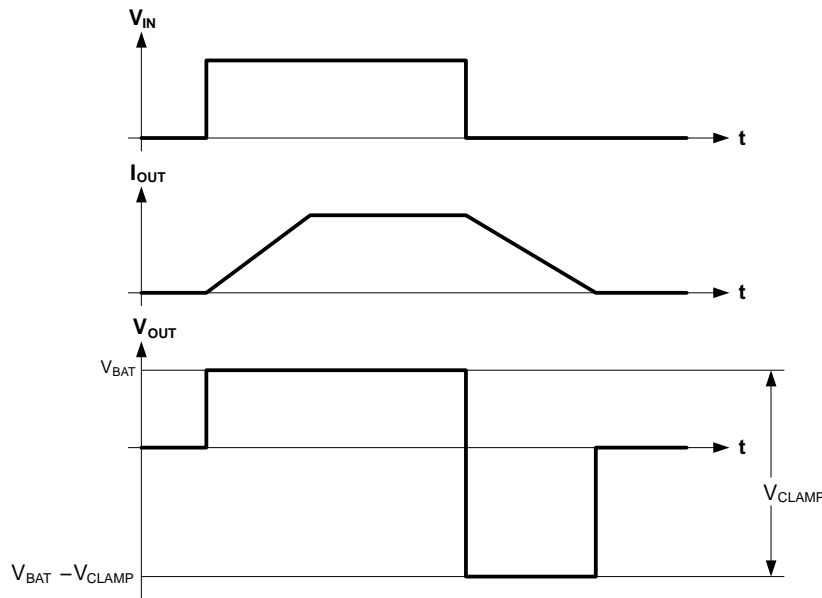

Figure 36. Inductive Load Switching

NCV84160

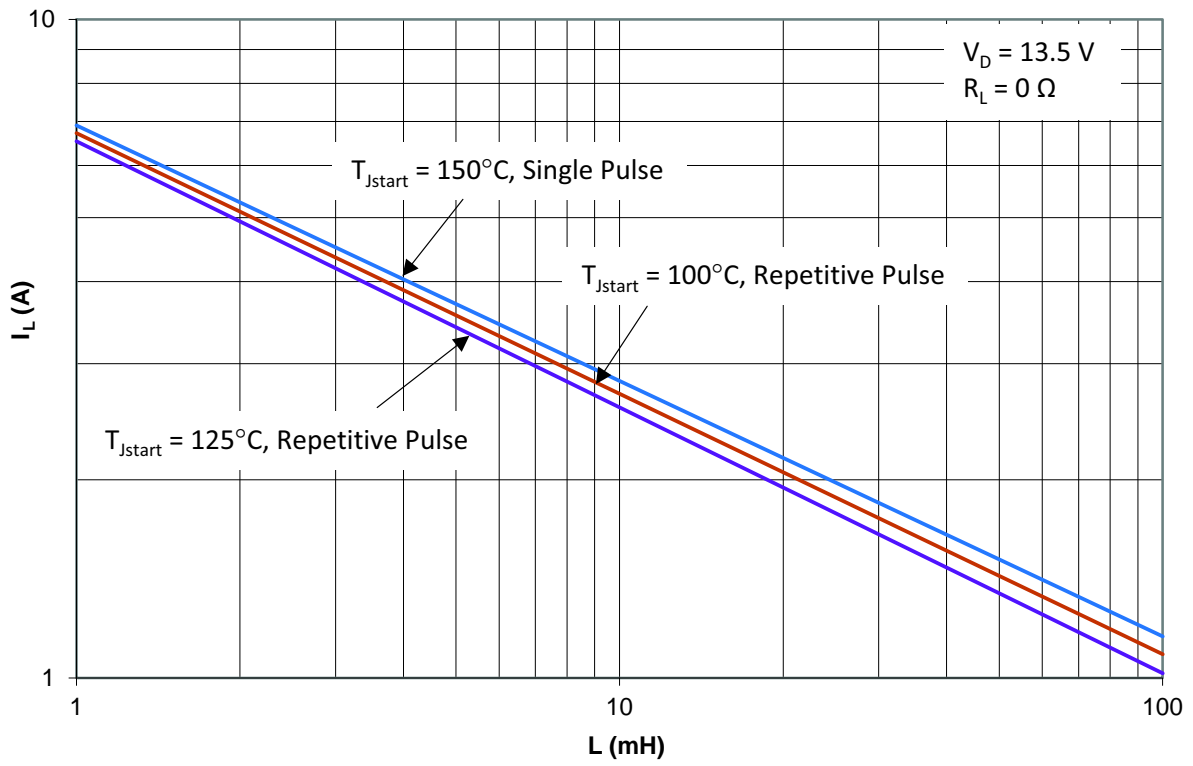

Figure 37. Maximum Switch-Off Current vs. Load Inductance, $V_D = 13.5\text{ V}$; $R_L = 0\ \Omega$

Open Load Detection in OFF State

Open load diagnosis in the OFF-state can be performed by activating an external resistive pull-up path (RPU) to VBAT. To calculate the pull-up resistance, external leakage

currents (designed pull-down resistance, humidity-induced leakage etc) as well as the open load threshold voltage VOL have to be taken into account.

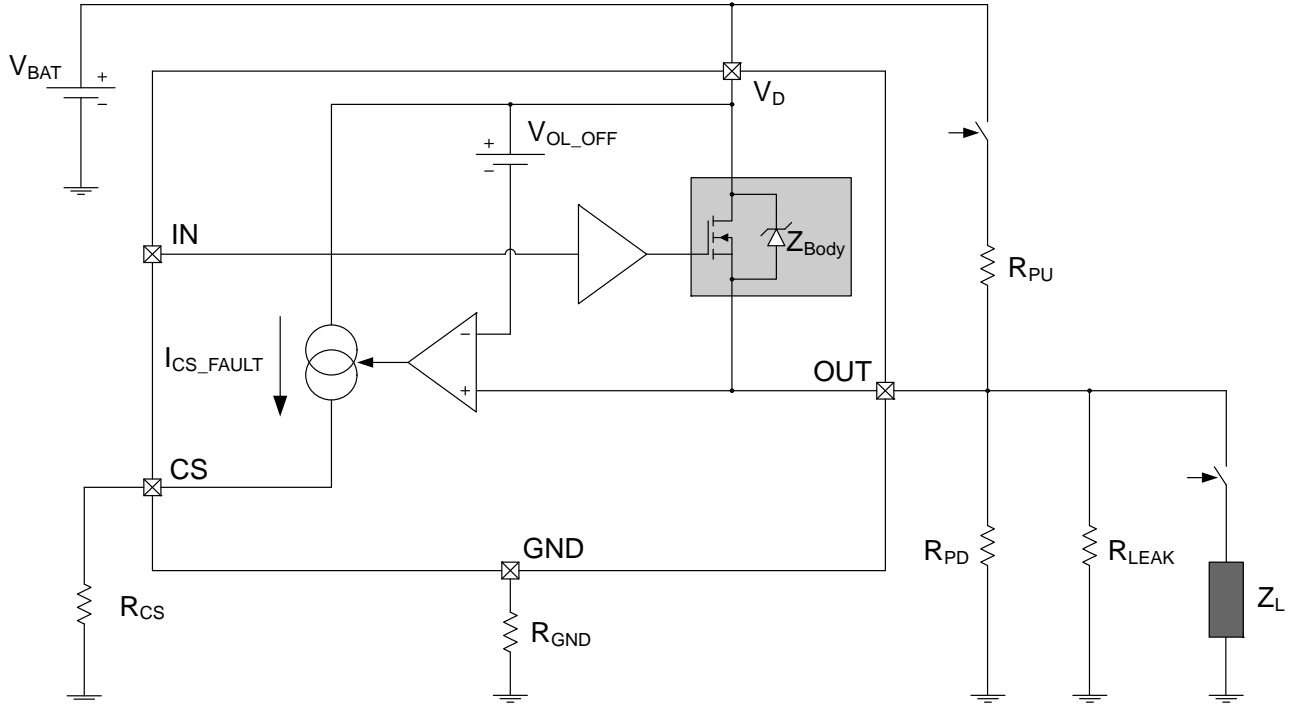

Figure 38. Off State Open Load Detection Circuit

Current Sense in PWM Mode

While operating in PWM mode, the current sense functionality can be used, but the timing of the input signal and the response time of the current sense need to be considered. When operating in PWM mode, the following performance is to be expected. The CS_DIS pin should be left low to eliminate any unnecessary delay time to the circuit. When V_IN switches from low to high, there will be

a typical delay (tCS_High2) before the current sense responds. Once this timing delay has passed, the rise time of the current sense output (Δt_{CS_High2}) also needs to be considered. When V_IN switches from high to low a delay time (tCS_Low1) needs to be considered. As long as these timing delays are allowed, the current sense pin can be operated in PWM mode.

NCV84160

PACKAGE AND PCB THERMAL DATA (Note 1)

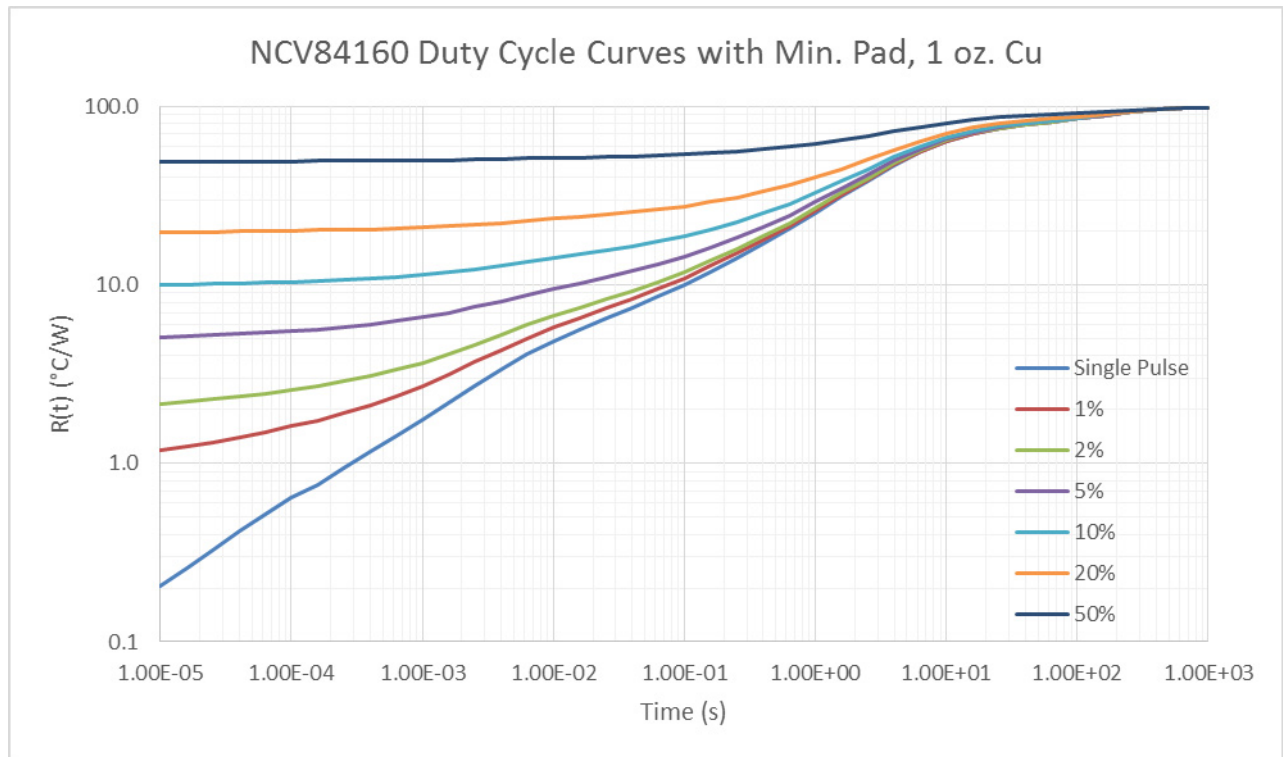

Figure 39. Junction to Ambient Transient Thermal Impedance (Min. Pad Cu Area)

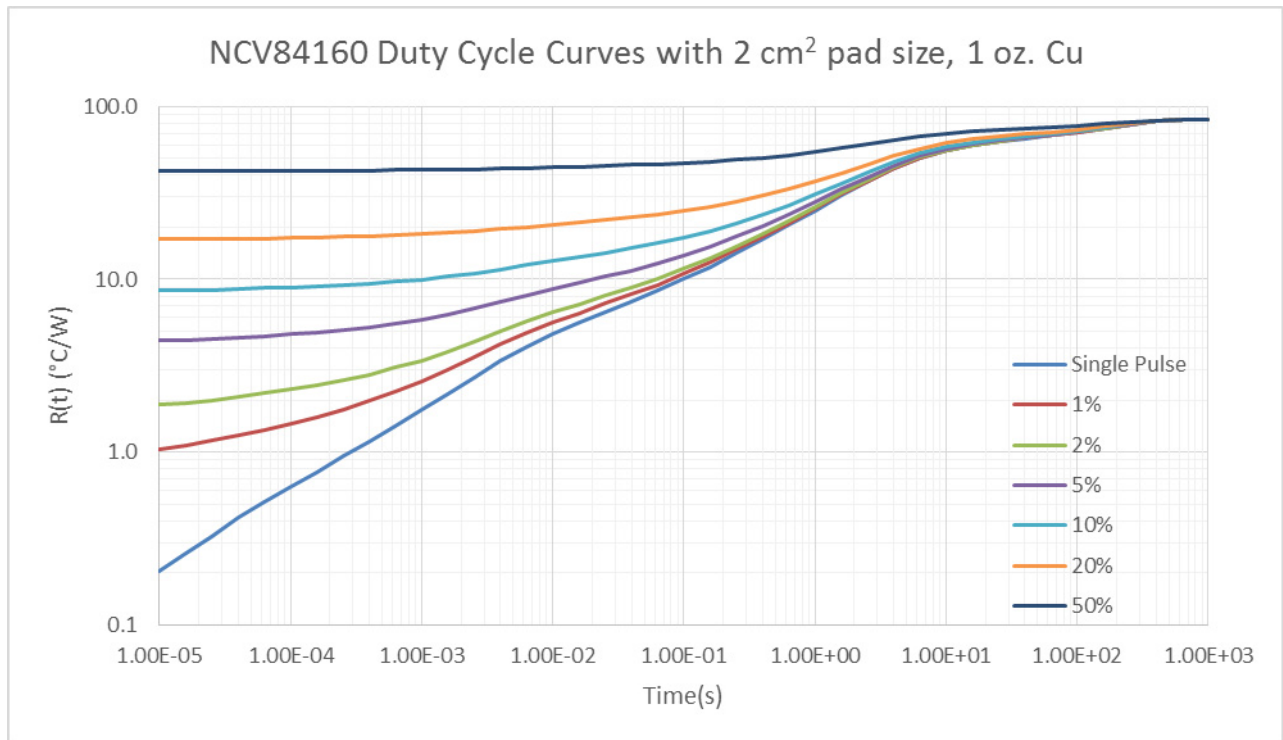

Figure 40. Junction to Ambient Transient Thermal Impedance (2 cm² Cu Area)

1. PCB FR4 Area = 4.8 cm x 4.8 cm, PCB Thickness = 1.6 mm, backside plane covered with 1 oz. Cu (backside plane not electrically connected)

MECHANICAL CASE OUTLINE PACKAGE DIMENSIONS

ON Semiconductor®



SOIC-8 NB
CASE 751-07
ISSUE AK

DATE 16 FEB 2011



SCALE 1:1

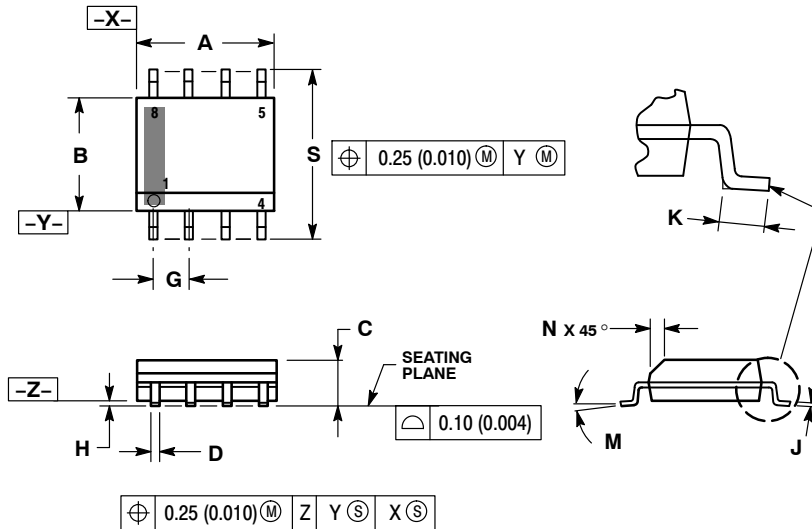

NOTES:

1. DIMENSIONING AND TOLERANCING PER ANSI Y14.5M, 1982.
2. CONTROLLING DIMENSION: MILLIMETER.
3. DIMENSION A AND B DO NOT INCLUDE MOLD PROTRUSION.
4. MAXIMUM MOLD PROTRUSION 0.15 (0.006) PER SIDE.
5. DIMENSION D DOES NOT INCLUDE DAMBAR PROTRUSION. ALLOWABLE DAMBAR PROTRUSION SHALL BE 0.127 (0.005) TOTAL IN EXCESS OF THE D DIMENSION AT MAXIMUM MATERIAL CONDITION.
6. 751-01 THRU 751-06 ARE OBSOLETE. NEW STANDARD IS 751-07.

DIM	MILLIMETERS		INCHES	
	MIN	MAX	MIN	MAX
A	4.80	5.00	0.189	0.197
B	3.80	4.00	0.150	0.157
C	1.35	1.75	0.053	0.069
D	0.33	0.51	0.013	0.020
G	1.27 BSC		0.050 BSC	
H	0.10	0.25	0.004	0.010
J	0.19	0.25	0.007	0.010
K	0.40	1.27	0.016	0.050
M	0°	8°	0°	8°
N	0.25	0.50	0.010	0.020
S	5.80	6.20	0.228	0.244

SOLDERING FOOTPRINT*

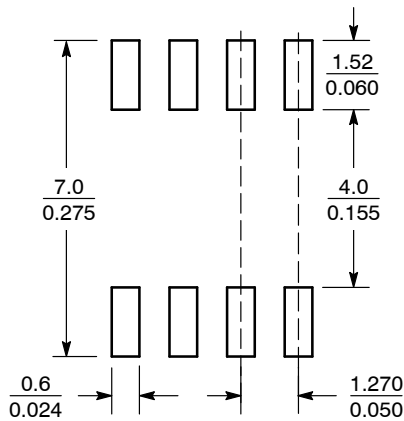

SCALE 6:1 (mm/inches)

GENERIC MARKING DIAGRAM*

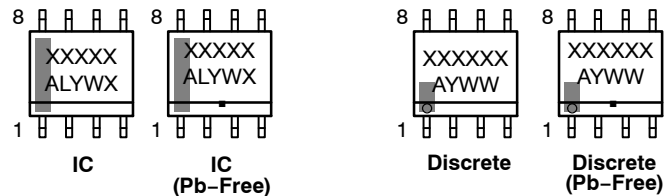

XXXXXX = Specific Device Code
 A = Assembly Location
 L = Wafer Lot
 Y = Year
 W = Work Week
 ■ = Pb-Free Package

XXXXXXX = Specific Device Code
 A = Assembly Location
 Y = Year
 WW = Work Week
 ■ = Pb-Free Package

*This information is generic. Please refer to device data sheet for actual part marking. Pb-Free indicator, "G", may or not be present.

*For additional information on our Pb-Free strategy and soldering details, please download the ON Semiconductor Soldering and Mounting Techniques Reference Manual, SOLDERRM/D.

STYLES ON PAGE 2

DOCUMENT NUMBER:	98ASB42564B	Electronic versions are uncontrolled except when accessed directly from the Document Repository. Printed versions are uncontrolled except when stamped "CONTROLLED COPY" in red.
STATUS:	ON SEMICONDUCTOR STANDARD	
NEW STANDARD:		
DESCRIPTION:	SOIC-8, NB	PAGE 1 OF 3

SOIC-8 NB
CASE 751-07
ISSUE AK

DATE 16 FEB 2011

- | | | | |
|---|--|--|--|
| <p>STYLE 1:
 PIN 1. EMITTER
 2. COLLECTOR
 3. COLLECTOR
 4. EMITTER
 5. EMITTER
 6. BASE
 7. BASE
 8. EMITTER</p> | <p>STYLE 2:
 PIN 1. COLLECTOR, DIE, #1
 2. COLLECTOR, #1
 3. COLLECTOR, #2
 4. COLLECTOR, #2
 5. BASE, #2
 6. EMITTER, #2
 7. BASE, #1
 8. EMITTER, #1</p> | <p>STYLE 3:
 PIN 1. DRAIN, DIE #1
 2. DRAIN, #1
 3. DRAIN, #2
 4. DRAIN, #2
 5. GATE, #2
 6. SOURCE, #2
 7. GATE, #1
 8. SOURCE, #1</p> | <p>STYLE 4:
 PIN 1. ANODE
 2. ANODE
 3. ANODE
 4. ANODE
 5. ANODE
 6. ANODE
 7. ANODE
 8. COMMON CATHODE</p> |
| <p>STYLE 5:
 PIN 1. DRAIN
 2. DRAIN
 3. DRAIN
 4. DRAIN
 5. GATE
 6. GATE
 7. SOURCE
 8. SOURCE</p> | <p>STYLE 6:
 PIN 1. SOURCE
 2. DRAIN
 3. DRAIN
 4. SOURCE
 5. SOURCE
 6. GATE
 7. GATE
 8. SOURCE</p> | <p>STYLE 7:
 PIN 1. INPUT
 2. EXTERNAL BYPASS
 3. THIRD STAGE SOURCE
 4. GROUND
 5. DRAIN
 6. GATE 3
 7. SECOND STAGE Vd
 8. FIRST STAGE Vd</p> | <p>STYLE 8:
 PIN 1. COLLECTOR, DIE #1
 2. BASE, #1
 3. BASE, #2
 4. COLLECTOR, #2
 5. COLLECTOR, #2
 6. EMITTER, #2
 7. EMITTER, #1
 8. COLLECTOR, #1</p> |
| <p>STYLE 9:
 PIN 1. EMITTER, COMMON
 2. COLLECTOR, DIE #1
 3. COLLECTOR, DIE #2
 4. EMITTER, COMMON
 5. EMITTER, COMMON
 6. BASE, DIE #2
 7. BASE, DIE #1
 8. EMITTER, COMMON</p> | <p>STYLE 10:
 PIN 1. GROUND
 2. BIAS 1
 3. OUTPUT
 4. GROUND
 5. GROUND
 6. BIAS 2
 7. INPUT
 8. GROUND</p> | <p>STYLE 11:
 PIN 1. SOURCE 1
 2. GATE 1
 3. SOURCE 2
 4. GATE 2
 5. DRAIN 2
 6. DRAIN 2
 7. DRAIN 1
 8. DRAIN 1</p> | <p>STYLE 12:
 PIN 1. SOURCE
 2. SOURCE
 3. SOURCE
 4. GATE
 5. DRAIN
 6. DRAIN
 7. DRAIN
 8. DRAIN</p> |
| <p>STYLE 13:
 PIN 1. N.C.
 2. SOURCE
 3. SOURCE
 4. GATE
 5. DRAIN
 6. DRAIN
 7. DRAIN
 8. DRAIN</p> | <p>STYLE 14:
 PIN 1. N-SOURCE
 2. N-GATE
 3. P-SOURCE
 4. P-GATE
 5. P-DRAIN
 6. P-DRAIN
 7. N-DRAIN
 8. N-DRAIN</p> | <p>STYLE 15:
 PIN 1. ANODE 1
 2. ANODE 1
 3. ANODE 1
 4. ANODE 1
 5. CATHODE, COMMON
 6. CATHODE, COMMON
 7. CATHODE, COMMON
 8. CATHODE, COMMON</p> | <p>STYLE 16:
 PIN 1. EMITTER, DIE #1
 2. BASE, DIE #1
 3. EMITTER, DIE #2
 4. BASE, DIE #2
 5. COLLECTOR, DIE #2
 6. COLLECTOR, DIE #2
 7. COLLECTOR, DIE #1
 8. COLLECTOR, DIE #1</p> |
| <p>STYLE 17:
 PIN 1. VCC
 2. V2OUT
 3. V1OUT
 4. TXE
 5. RXE
 6. VEE
 7. GND
 8. ACC</p> | <p>STYLE 18:
 PIN 1. ANODE
 2. ANODE
 3. SOURCE
 4. GATE
 5. DRAIN
 6. DRAIN
 7. CATHODE
 8. CATHODE</p> | <p>STYLE 19:
 PIN 1. SOURCE 1
 2. GATE 1
 3. SOURCE 2
 4. GATE 2
 5. DRAIN 2
 6. MIRROR 2
 7. DRAIN 1
 8. MIRROR 1</p> | <p>STYLE 20:
 PIN 1. SOURCE (N)
 2. GATE (N)
 3. SOURCE (P)
 4. GATE (P)
 5. DRAIN
 6. DRAIN
 7. DRAIN
 8. DRAIN</p> |
| <p>STYLE 21:
 PIN 1. CATHODE 1
 2. CATHODE 2
 3. CATHODE 3
 4. CATHODE 4
 5. CATHODE 5
 6. COMMON ANODE
 7. COMMON ANODE
 8. CATHODE 6</p> | <p>STYLE 22:
 PIN 1. I/O LINE 1
 2. COMMON CATHODE/VCC
 3. COMMON CATHODE/VCC
 4. I/O LINE 3
 5. COMMON ANODE/GND
 6. I/O LINE 4
 7. I/O LINE 5
 8. COMMON ANODE/GND</p> | <p>STYLE 23:
 PIN 1. LINE 1 IN
 2. COMMON ANODE/GND
 3. COMMON ANODE/GND
 4. LINE 2 IN
 5. LINE 2 OUT
 6. COMMON ANODE/GND
 7. COMMON ANODE/GND
 8. LINE 1 OUT</p> | <p>STYLE 24:
 PIN 1. BASE
 2. EMITTER
 3. COLLECTOR/ANODE
 4. COLLECTOR/ANODE
 5. CATHODE
 6. CATHODE
 7. COLLECTOR/ANODE
 8. COLLECTOR/ANODE</p> |
| <p>STYLE 25:
 PIN 1. VIN
 2. N/C
 3. REXT
 4. GND
 5. IOUT
 6. IOUT
 7. IOUT
 8. IOUT</p> | <p>STYLE 26:
 PIN 1. GND
 2. dv/dt
 3. ENABLE
 4. ILIMIT
 5. SOURCE
 6. SOURCE
 7. SOURCE
 8. VCC</p> | <p>STYLE 27:
 PIN 1. ILIMIT
 2. OVLO
 3. UVLO
 4. INPUT+
 5. SOURCE
 6. SOURCE
 7. SOURCE
 8. DRAIN</p> | <p>STYLE 28:
 PIN 1. SW_TO_GND
 2. DASIC_OFF
 3. DASIC_SW_DET
 4. GND
 5. V_MON
 6. VBULK
 7. VBULK
 8. VIN</p> |
| <p>STYLE 29:
 PIN 1. BASE, DIE #1
 2. EMITTER, #1
 3. BASE, #2
 4. EMITTER, #2
 5. COLLECTOR, #2
 6. COLLECTOR, #2
 7. COLLECTOR, #1
 8. COLLECTOR, #1</p> | <p>STYLE 30:
 PIN 1. DRAIN 1
 2. DRAIN 1
 3. GATE 2
 4. SOURCE 2
 5. SOURCE 1/DRAIN 2
 6. SOURCE 1/DRAIN 2
 7. SOURCE 1/DRAIN 2
 8. GATE 1</p> | | |

DOCUMENT NUMBER:	98ASB42564B	Electronic versions are uncontrolled except when accessed directly from the Document Repository. Printed versions are uncontrolled except when stamped "CONTROLLED COPY" in red.
STATUS:	ON SEMICONDUCTOR STANDARD	
NEW STANDARD:		
DESCRIPTION:	SOIC-8, NB	PAGE 2 OF 3



ISSUE	REVISION	DATE
AB	ADDED STYLE 25. REQ. BY S. CHANG.	15 MAR 2004
AC	ADDED CORRECTED MARKING DIAGRAMS. REQ. BY S. FARRETTA.	13 AUG 2004
AD	CORRECTED MARKING DIAGRAM FOR DISCRETE. REQ. BY S. FARRETTA.	18 NOV 2004
AE	UPDATED SCALE ON FOOTPRINT. REQ. BY S. WEST.	31 JAN 2005
AF	UPDATED MARKING DIAGRAMS. REQ. BY S. WEST. ADDED STYLE 26. REQ. BY S. CHANG.	14 APR 2005
AG	ADDED STYLE 27. REQ. BY S. CHANG.	30 JUN 2005
AH	ADDED STYLE 28. REQ. BY S. CHANG.	09 MAR 2006
AJ	ADDED STYLE 29. REQ. BY D. HELZER.	19 SEP 2007
AK	ADDED STYLE 30. REQ. BY I. CAMBALIZA.	16 FEB 2011

ON Semiconductor and  are registered trademarks of Semiconductor Components Industries, LLC (SCILLC). SCILLC reserves the right to make changes without further notice to any products herein. SCILLC makes no warranty, representation or guarantee regarding the suitability of its products for any particular purpose, nor does SCILLC assume any liability arising out of the application or use of any product or circuit, and specifically disclaims any and all liability, including without limitation special, consequential or incidental damages. "Typical" parameters which may be provided in SCILLC data sheets and/or specifications can and do vary in different applications and actual performance may vary over time. All operating parameters, including "Typicals" must be validated for each customer application by customer's technical experts. SCILLC does not convey any license under its patent rights nor the rights of others. SCILLC products are not designed, intended, or authorized for use as components in systems intended for surgical implant into the body, or other applications intended to support or sustain life, or for any other application in which the failure of the SCILLC product could create a situation where personal injury or death may occur. Should Buyer purchase or use SCILLC products for any such unintended or unauthorized application, Buyer shall indemnify and hold SCILLC and its officers, employees, subsidiaries, affiliates, and distributors harmless against all claims, costs, damages, and expenses, and reasonable attorney fees arising out of, directly or indirectly, any claim of personal injury or death associated with such unintended or unauthorized use, even if such claim alleges that SCILLC was negligent regarding the design or manufacture of the part. SCILLC is an Equal Opportunity/Affirmative Action Employer. This literature is subject to all applicable copyright laws and is not for resale in any manner.

ON Semiconductor and  are trademarks of Semiconductor Components Industries, LLC dba ON Semiconductor or its subsidiaries in the United States and/or other countries. ON Semiconductor owns the rights to a number of patents, trademarks, copyrights, trade secrets, and other intellectual property. A listing of ON Semiconductor's product/patent coverage may be accessed at www.onsemi.com/site/pdf/Patent-Marking.pdf. ON Semiconductor reserves the right to make changes without further notice to any products herein. ON Semiconductor makes no warranty, representation or guarantee regarding the suitability of its products for any particular purpose, nor does ON Semiconductor assume any liability arising out of the application or use of any product or circuit, and specifically disclaims any and all liability, including without limitation special, consequential or incidental damages. Buyer is responsible for its products and applications using ON Semiconductor products, including compliance with all laws, regulations and safety requirements or standards, regardless of any support or applications information provided by ON Semiconductor. "Typical" parameters which may be provided in ON Semiconductor data sheets and/or specifications can and do vary in different applications and actual performance may vary over time. All operating parameters, including "Typicals" must be validated for each customer application by customer's technical experts. ON Semiconductor does not convey any license under its patent rights nor the rights of others. ON Semiconductor products are not designed, intended, or authorized for use as a critical component in life support systems or any FDA Class 3 medical devices or medical devices with a same or similar classification in a foreign jurisdiction or any devices intended for implantation in the human body. Should Buyer purchase or use ON Semiconductor products for any such unintended or unauthorized application, Buyer shall indemnify and hold ON Semiconductor and its officers, employees, subsidiaries, affiliates, and distributors harmless against all claims, costs, damages, and expenses, and reasonable attorney fees arising out of, directly or indirectly, any claim of personal injury or death associated with such unintended or unauthorized use, even if such claim alleges that ON Semiconductor was negligent regarding the design or manufacture of the part. ON Semiconductor is an Equal Opportunity/Affirmative Action Employer. This literature is subject to all applicable copyright laws and is not for resale in any manner.

PUBLICATION ORDERING INFORMATION

LITERATURE FULFILLMENT:

Literature Distribution Center for ON Semiconductor
19521 E. 32nd Pkwy, Aurora, Colorado 80011 USA
Phone: 303-675-2175 or 800-344-3860 Toll Free USA/Canada
Fax: 303-675-2176 or 800-344-3867 Toll Free USA/Canada
Email: orderlit@onsemi.com

N. American Technical Support: 800-282-9855 Toll Free
USA/Canada
Europe, Middle East and Africa Technical Support:
Phone: 421 33 790 2910

ON Semiconductor Website: www.onsemi.com

Order Literature: <http://www.onsemi.com/orderlit>

For additional information, please contact your local
Sales Representative