

# NCV7683

## Enhanced 100 mA Linear Current Regulator and Controller for Automotive Sequenced LED Lighting

The NCV7683 consists of eight linear programmable constant current sources. The part is designed for use in the regulation and control of LED based Rear Combination Lamps and blinking functions for automotive applications. System design with the NCV7683 allows for two programmed levels for stop (100% Duty Cycle) and tail illumination (programmable Duty Cycle), or an optional external PWM control can be implemented.

LED brightness levels are easily programmed (stop is programmed to the absolute current value, tail is programmed to the duty cycle) with two external resistors. The use of an optional external ballast FET allows for power distribution on designs requiring high currents. Set back power limit reduces the drive current during overvoltage conditions. This is most useful for low power applications when no external FET is used.

Sequencing functionality is activated, controlled, and programmed by individual pins. In addition to programming of the sequence interval, the device can sequence 8 individual output channels, 4 pairs of output channels, 2 quad output channels, or all 8 at once (for multi IC use at high currents).

Enhanced features of this device are a global enable function and display sequencing.

The device is available in a SSOP-24 package with exposed pad.

### Features

- Constant Current Outputs for LED String Drive
- LED Drive Current up to 100 mA per Channel
- Open LED String Diagnostic with Open-Drain Output in All Modes
- Slew Rate Control Eliminates EMI Concerns
- Low Dropout Operation for Pre-Regulator Applications
- External Modulation Capable
- On-chip 800 Hz Tail PWM Dimming
- Single Resistor for Stop Current Set Point
- Single Resistor for Tail Dimming Set Point
- Overvoltage Set Back Power Limitation
- Improved EMC Performance
- Programmable Latch-Off function on Open String
  - ◆ Restart Option of Unaffected Strings
- Over Temperature Fault Reporting
- Global Enable
- Display Sequencing
- SSOP-24 Fused Lead Package with Exposed Pad
- AEC-Q100 Qualified and PPAP Capable
- These are Pb-Free Devices

### Applications

- Rear Combination Lamps (RCL)
- Daytime Running Lights (DRL)
- Fog Lights
- Center High Mounted Stop Lamps (CHMSL) Arrays
- Turn Signal and Other Externally Modulated Applications
- Signature Lamp



ON Semiconductor®

[www.onsemi.com](http://www.onsemi.com)

### MARKING DIAGRAM

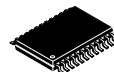

SSOP24 NB EP  
CASE 940AP



NCV7683 = Specific Device Code  
A = Assembly Location  
WL = Wafer Lot  
YY = Year  
WW = Work Week  
G = Pb-Free Package

(Note: Microdot may be in either location)

### ORDERING INFORMATION

Device	Package	Shipping†
NCV7683DQR2G	SSOP24-EP (Pb-Free)	2500 / Tape & Reel

†For information on tape and reel specifications, including part orientation and tape sizes, please refer to our Tape and Reel Packaging Specifications Brochure, BRD8011/D.

# NCV7683

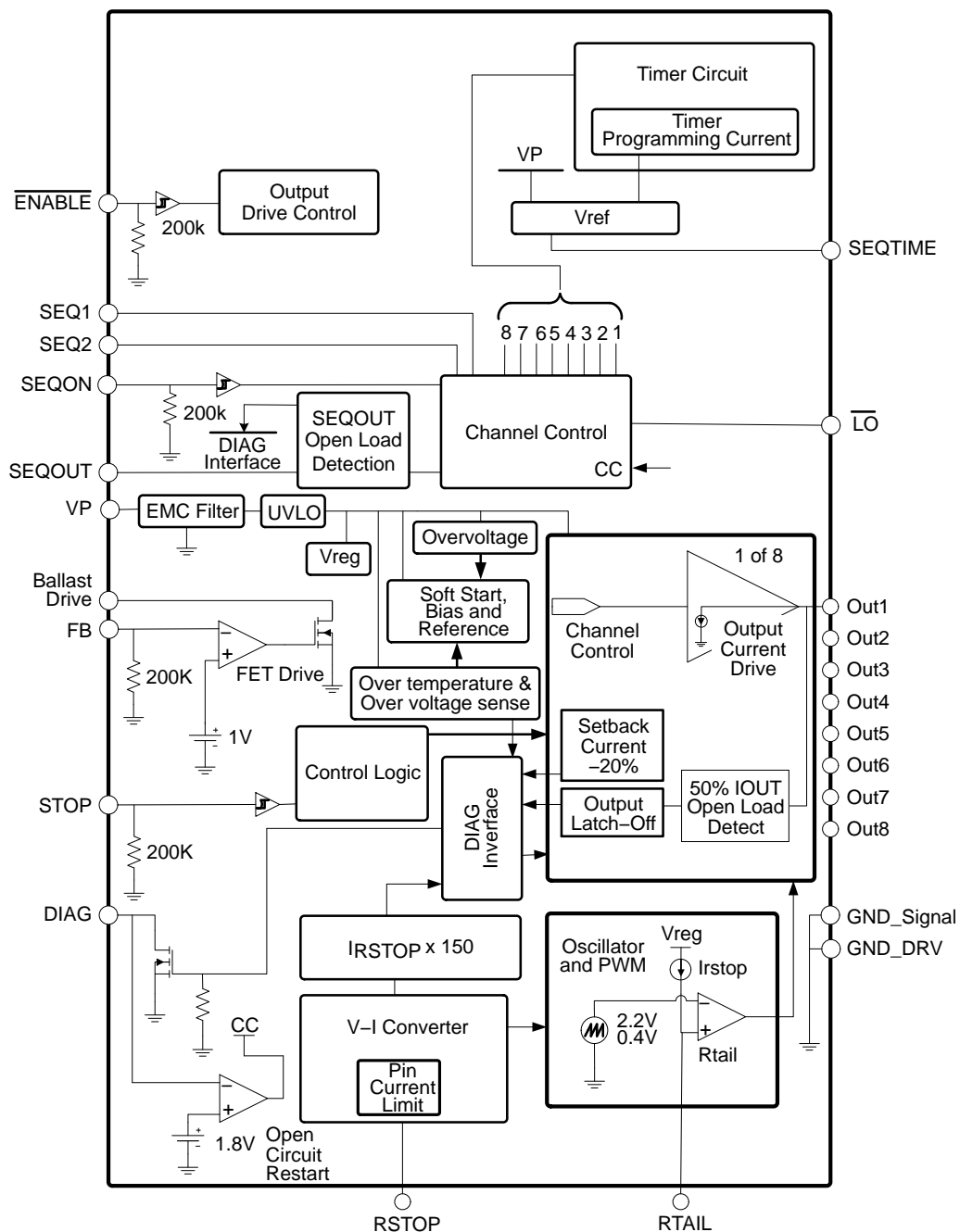

Figure 1. Block Diagram

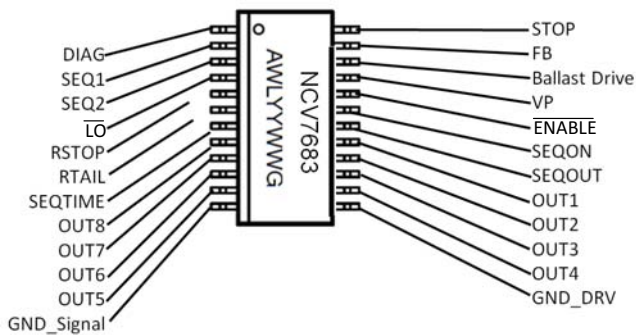
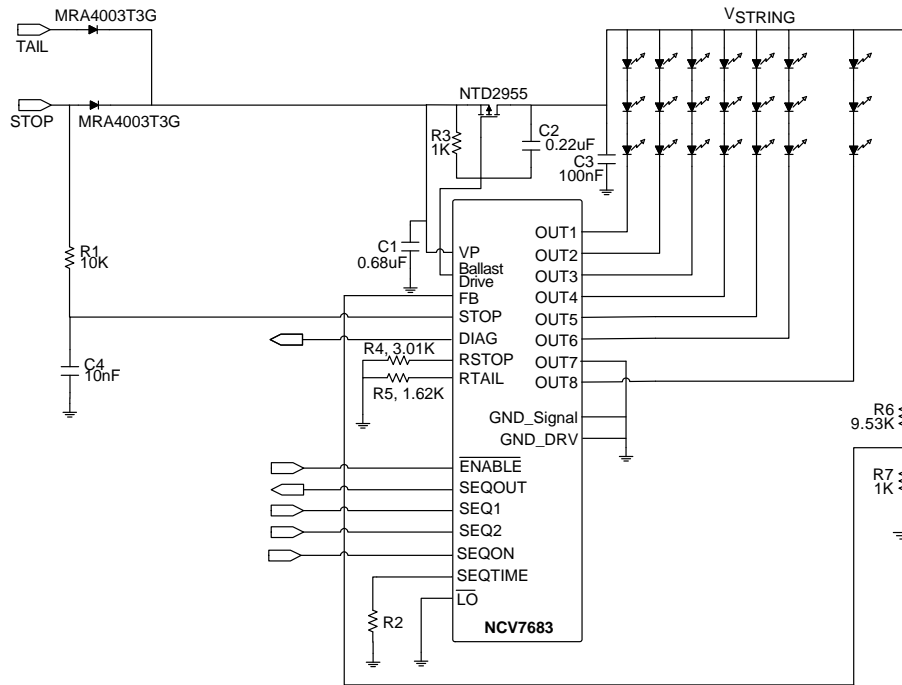

Figure 2. Pinout Diagram

# NCV7683



**Figure 3. Application Diagram with External FET Ballast Transistor**

R6 and R7 values shown yield 10.5 V regulation on V<sub>STRING</sub>.

C1 is for line noise and stability considerations.

C3 is for EMC considerations.

Unused OUT<sub>x</sub> channels should be shorted to ground as OUT7 shows in this example.

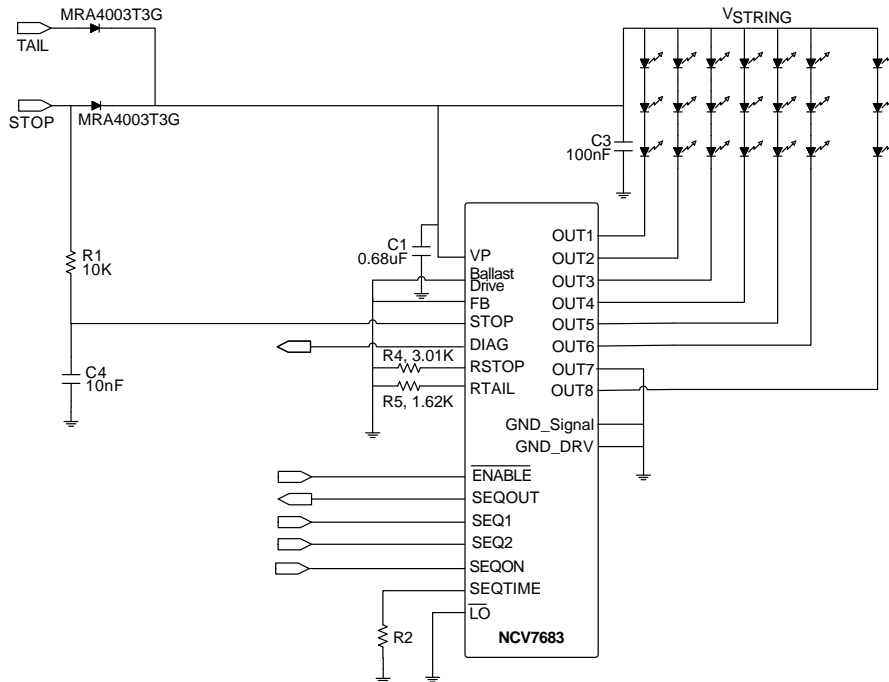

**Figure 4. Application Diagram without the FET Ballast Transistor**

When using the NCV7683 without the FET ballast transistor, tie the FB pin and Ballast Drive pin to GND.

Table 1. APPLICATION I/O TRUTH TABLE

EN	SEQON	STOP INPUT	TAIL MODE	OUTx LATCH OFF (w/ $\overline{LO}$ = GND)	OUTX CURRENT	FAULT STATE*	DIAG STATE**
1	X	X	X	no	OFF	-	1
0	0	0	0	no	OFF	-	1
0	0	1	X	no	I <sub>STOP</sub>	NORMAL	0
0	0	1	X	no	I <sub>STOP</sub>	OPEN CIRCUIT***	1
0	0	1	X	yes	OFF	OPEN CIRCUIT***	1
0	0	0	1	no	PWM	NORMAL	0
0	0	0	1	no	PWM	OPEN CIRCUIT***	PWM
0	1	X	X	no	I <sub>STOP</sub>	NORMAL	0
0	1	X	X	no	I <sub>STOP</sub>	OPEN CIRCUIT***	1
0	1	X	X	yes	OFF	OPEN CIRCUIT***	1

Reference Figures below.

X = don't care

0 = LOW

1 = HIGH

\* Open Circuit, RSTOP Current Limit, Set Back Current Limit down 20%, and thermal shutdown

\*\*Pull-up resistor to DIAG and SEQOUT required.

\*\*\* OPEN CIRCUIT = Any string or SEQOUT open.

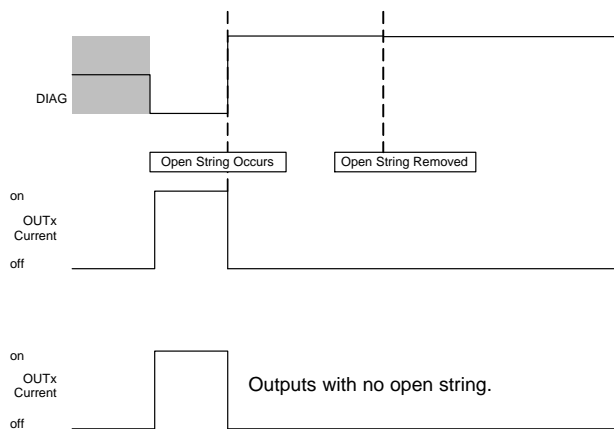

Figure 5. DIAG timing diagram WITH Open String Latch Active All outputs latch off.

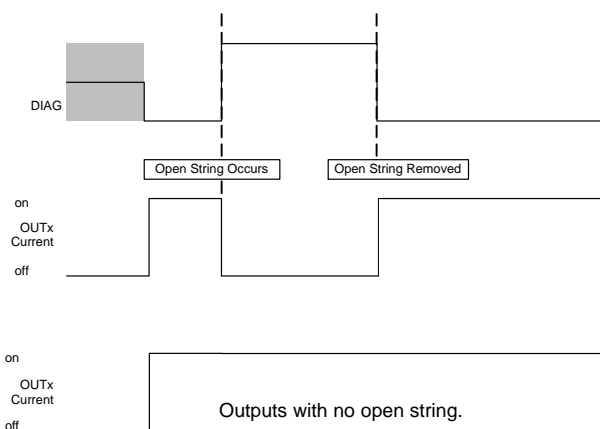
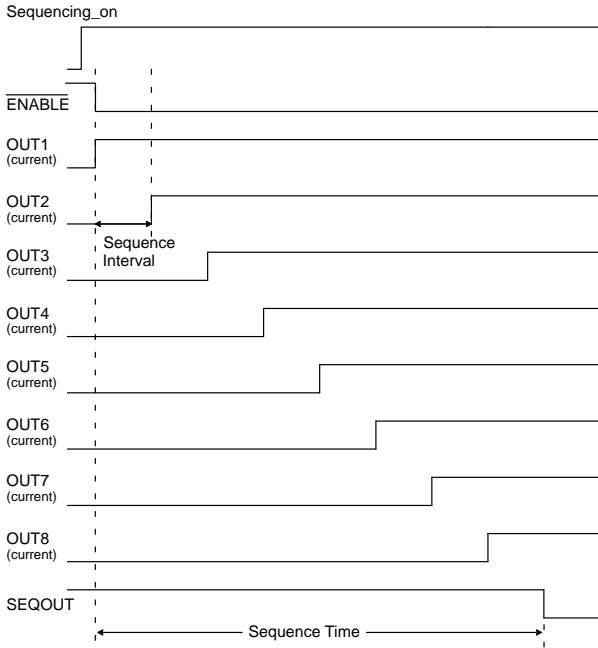

Figure 6. DIAG timing diagram WITHOUT Open String Latch Active No outputs are turned off. DIAG will report the state.

**Sequence Programming Timing Diagrams**

The four timing diagrams show the options available for sequencing of the 8 outputs dependent on the state of SEQ1 and SEQ2.

1. 8 individual sequence intervals.
2. 4 pairs of sequence intervals.
3. 2 quads of sequence intervals.
4. 1 single sequence interval.



**Figure 7. Sequencing Timing Diagram (SEQ1 = 0, SEQ2 = 0)**

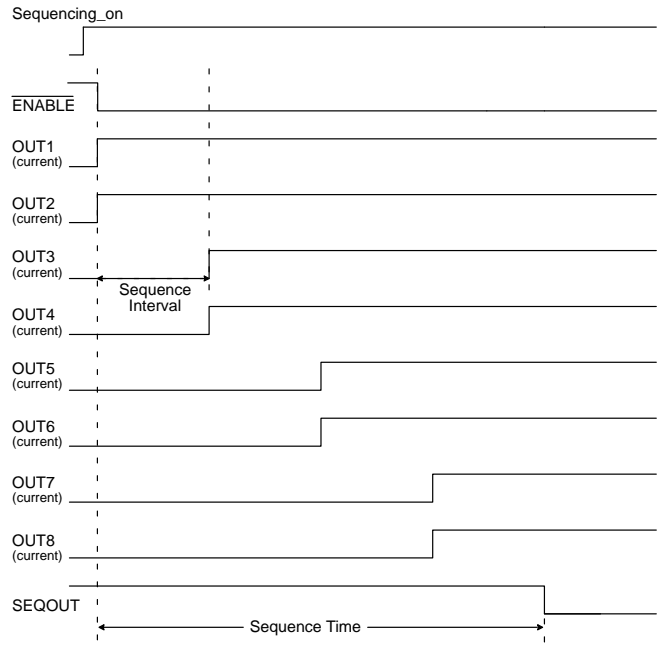

**Figure 8. Sequencing Timing Diagram (SEQ1 = 1, SEQ2 = 0)**

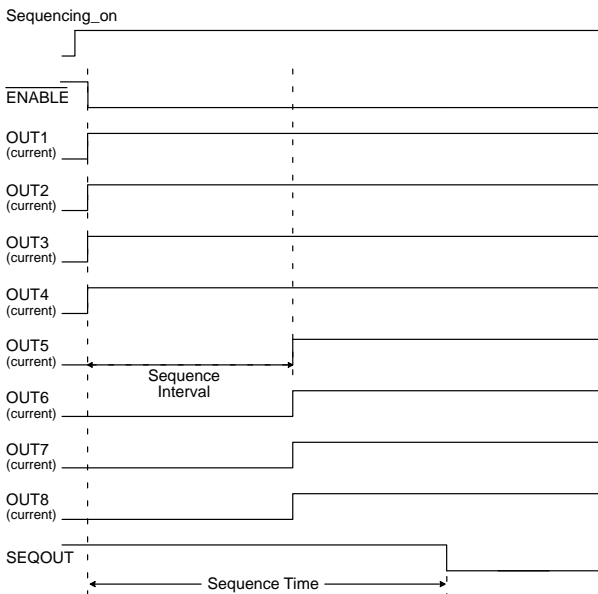

**Figure 9. Sequencing Timing Diagram (SEQ1 = 0, SEQ2 = 1)**

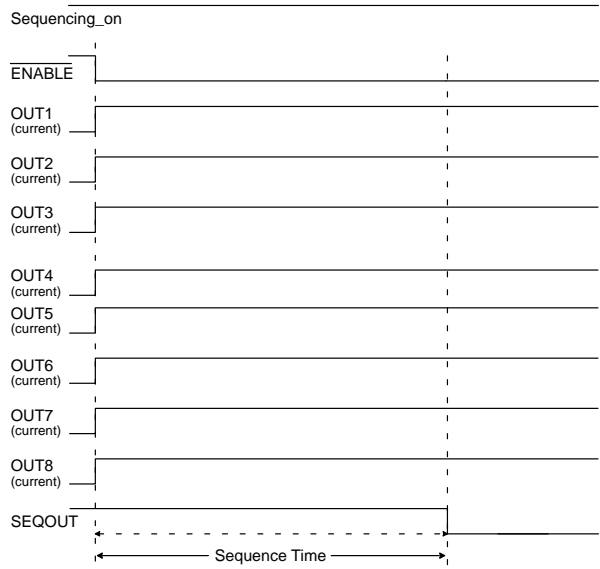

**Figure 10. Sequencing Timing Diagram (SEQ1 = 1, SEQ2 = 1)**

The sequencing function is triggered by a logic level high to low signal on the  $\overline{\text{ENABLE}}$  pin.

0=ground

1=floating

# NCV7683

**Table 2. PIN FUNCTION DESCRIPTION**

SSOP-24 Exposed Pad Package		
Pin #	Label	Description
1	DIAG	Open-drain diagnostic output. Requires a pull-up resistor. Reporting Open Circuit, RSTOP Current Limit, Set Back Current Limit down 20%, and thermal shutdown. Normal Operation = LOW. Open Load reset input. Ground if not used (only if latching is not used).
2	SEQ1	Grounding this pin changes the output sequencing. Reference the sequencing section of the datasheet.
3	SEQ2	Grounding this pin changes the output sequencing. Reference the sequencing section of the datasheet.
4	L $\bar{O}$	Latch Off. Ground this pin for latch off function.
5	RSTOP	Stop current bias program resistor. Referenced to ground (pin 12).
6	RTAIL	Tail current duty cycle PWM program resistor. Referenced to ground (pin 12). Ground pin if using external modulation.
7	SEQTIME	Sequence Time program resistor. Referenced to ground (pin 12).
8	OUT8	Channel 8 constant current output to LED. Unused pin should be grounded (pin 13).
9	OUT7	Channel 7 constant current output to LED. Unused pin should be grounded (pin 13).
10	OUT6	Channel 6 constant current output to LED. Unused pin should be grounded (pin 13).
11	OUT5	Channel 5 constant current output to LED. Unused pin should be grounded (pin 13).
12	GND_Signal	Low Current Logic Ground.
13	GND_DRV	High Current Driver Ground. Pin is fused to the epad.
14	OUT4	Channel 4 constant current output to LED. Unused pin should be grounded (pin 13).
15	OUT3	Channel 3 constant current output to LED. Unused pin should be grounded (pin 13).
16	OUT2	Channel 2 constant current output to LED. Unused pin should be grounded (pin 13).
17	OUT1	Channel 1 constant current output to LED. Unused pin should be grounded (pin 13).
18	SEQOUT	Open-drain output. Requires a pull-up resistor. Follows ENABLE pin after delay of OUT8 with SEQON high.
19	SEQON	High turns on 1-8 output sequencing.
20	ENABLE	Global enable input. Low turns device on.
21	VP	Supply voltage input.
22	Ballast Drive	Gate drive for external power distribution PFET. Ground if not used.
23	FB	Feedback Sense node for VP regulation. Use feedback resistor divider or connect to GND.
24	STOP	Stop Logic Input. External Modulation Input when VP is high.
epad	epad	Ground. Do not connect to pcb traces other than GND.

# NCV7683

**Table 3. MAXIMUM RATINGS** (Voltages are with respect to device substrate.)

Rating	Value	Unit
Supply Input (VP, Ballast Drive, STOP, DIAG, ENABLE, SEQON, SEQOUT) DC Peak Transient	-0.3 to 40 40	V
Output Pin Voltage (OUTX)	-0.3 to 40	V
Output Pin Current (OUTX)	200	mA
DIAG Pin Current	10	mA
Input Voltage (RTAIL, RSTOP, FB, SEQTIME, SEQ1, SEQ2, LO)	-0.3 to 3.6	V
Junction Temperature, T <sub>J</sub>	-40 to 150	°C
Peak Reflow Soldering Temperature: Lead-free 60 to 150 seconds at 217°C (Note 1)	260 peak	°C

Stresses exceeding those listed in the Maximum Ratings table may damage the device. If any of these limits are exceeded, device functionality should not be assumed, damage may occur and reliability may be affected.

**Table 4. ATTRIBUTES**

Characteristic	Value
ESD Capability Human Body Model Machine Model	≥ ± 4.0 kV ≥ ± 200 V
Moisture Sensitivity (Note 1)	MSL3
Storage Temperature	-55 to 150°C
Package Thermal Resistance (Note 2) SSOP24 Junction-to-Board, R <sub>θJB</sub> Junction-to-Ambient, R <sub>θJA</sub> Junction-to-Lead, R <sub>θJL</sub>	18°C/W 78°C/W 54°C/W

- For additional information, see or download ON Semiconductor's Soldering and Mounting Techniques Reference Manual, SOLDERRM/D, and Application Note AND8003/D.
- Values represent typical still air steady-state thermal performance on 1 oz. copper FR4 PCB with 645 mm<sup>2</sup> copper area.

# NCV7683

**Table 5. ELECTRICAL CHARACTERISTICS**

(4.5 V < VP < 16 V, STOP = VP, RSTOP = 3.01 kΩ, RTAIL = 1.62 kΩ, RSEQTIME = 4.99 kΩ, -40°C ≤ TJ ≤ 150°C, unless otherwise specified.)

Characteristic	Conditions	Min	Typ	Max	Unit
<b>GENERAL PARAMETERS</b>					
Quiescent Current (IOUTx = 50 mA) STOP mode Tail mode Fault mode	VP = 16 V VP = 16 V VP = 16 V, STOP = 0 V, OUTx = 0 mA, Disconnected output	- - -	6 5 -	12 12 2.0	mA
Driver Ground Pin Current (pin12)	IOUT1 to IOUT8 = 50 mA	-	400	500	mA
Output Under Voltage Lockout	VP Rising	3.8	4.1	4.4	V
Output Under Voltage Lockout Hysteresis		-	200	-	mV
Open Load Disable Threshold		7.2	7.7	8.2	V
Open Load Disable Hysteresis		-	200	-	mV

## THERMAL LIMIT

Thermal Shutdown	(Note 3)	150	175	-	°C
Thermal Hysteresis	(Note 3)	-	15	-	°C

## CURRENT SOURCE OUTPUTS

Output Current	OUTX = 0.5 V OUTX = 1 V, RSTOP = 1.5 K	45 90	50 100	55 110	mA
Maximum Regulated Output Current	0.5V to 16V	100	-	-	mA
Current Matching	$\left[ \frac{2I_{OUTx(min)}}{I_{OUTx(min)} + I_{OUTx(max)}} - 1 \right] \times 100$ $\left[ \frac{2I_{OUTx(max)}}{I_{OUTx(min)} + I_{OUTx(max)}} - 1 \right] \times 100$	-4	0	4	%
Line Regulation	9 V ≤ VP ≤ 16 V	-	1.2	6.0	mA
Open Circuit Detection Threshold	25 mA 50 mA	25 35	50 50	75 65	% of Output Current
Current Slew Rate	Iout = 44 mA, 10% to 90% points	-	6	15	mA/μs
Overvoltage Set Back Threshold	@ 99% Iout	16.0	17.2	18.4	V
Overvoltage Set Back Current	VP = 20 V (Note 4)	-	78	-	%Iout
Diag Reporting of Set Back Current		-	80	-	%Iout
Output Off Leakage	EN = high	-	-	1	μA

## FET DRIVER

Ballast Drive DC Bias Sink Current	FB = 1.5 V, Ballast Drive = 3 V FB = 0.5 V, Ballast Drive = 3 V	- 4	1.0 13	2.4 20	mA
Ballast Drive Reference Voltage		0.92	1.00	1.08	V

## STOP / ENABLE / SEQON LOGIC

Input High Threshold		0.75	1.25	1.75	V
Input Low Threshold		0.70	1.00	1.44	V
VIN Hysteresis		100	250	400	mV
Input Impedance	Vin = 14 V	120	200	300	kΩ

3. Designed to meet these characteristics over the stated voltage and temperature recommended operating ranges, though may not be 100% parametrically tested in production.

4. The output current degrades at a rate of 8%/V.



# NCV7683

**Table 5. ELECTRICAL CHARACTERISTICS**

(4.5 V < VP < 16 V, STOP = VP, RSTOP = 3.01 kΩ, RTAIL = 1.62 kΩ, RSEQTIME = 4.99 kΩ, -40°C ≤ TJ ≤ 150°C, unless otherwise specified.)

Characteristic	Conditions	Min	Typ	Max	Unit
----------------	------------	-----	-----	-----	------

## SEQ1/SEQ2/L0 LOGIC

Input High Threshold		0.75	1.25	1.75	V
Input Low Threshold		0.70	1.00	1.44	V
V <sub>IN</sub> Hysteresis		100	250	400	mV
Input Pull-up Current	SEQx = 0 V	5	10	20	μA

## CURRENT PROGRAMMING

RSTOP Bias Voltage	Stop current programming voltage	0.94	1.00	1.06	V
RSTOP K multiplier I <sub>OUTX</sub> /I <sub>RSTOP</sub>		-	150	-	-
RSTOP Over Current Detection	RSTOP = 0 V	0.70	1.00	1.45	mA
RTAIL Bias Current	Tail duty cycle programming current	290	330	370	μA
Duty Cycle	RTAIL = 0.49 V RTAIL = 0.76 V RTAIL = 1.66 V	3.5 17 59.5	5 20 70	6.5 23 80.5	%
SEQTIME Voltage		0.94	1.00	1.06	V

## DIAG / SEQOUT OUTPUT

Output Low Voltage	Output Active, I <sub>DIAG,SEQOUT</sub> = 1 mA	-	0.1	0.40	V
DIAG Output Leakage	V <sub>DIAG</sub> = 5 V	-	-	10	μA
Open Load Reset Voltage on DIAG		1.6	1.8	2.0	V
SEQOUT Open Load Detection Threshold Voltage		0.70	0.8	0.90	V
SEQOUT Open Load Detection Sink Current		10	20	35	μA

## AC CHARACTERISTICS

Stop Turn-on Delay Time	V(STOP) > 1.75 V to I(OUTx) = 90%	-	14	45	μsec
Stop Turn-off Delay Time	V(STOP) < 0.75 V to I(OUTx) = 10%	-	14	45	μsec
PWM Frequency	STOP = 0 V	400	800	1200	Hz
Open Circuit to DIAG Reporting	4.8 mA pull-up to VP, V(DIAG) > 1.5 V	1	2	4	μs
Sequence Time / R <sub>SEQTIME</sub>	SEQTIME = 1K to 10K	45.5	49	52.5	msec kohm
Sequence Re-Enable Time / R <sub>SEQTIME</sub>	SEQTIME = 1K to 10K	45.5	49	52.5	msec kohm
VP Turn-on Time		0.55	0.80	1.2	msec

3. Designed to meet these characteristics over the stated voltage and temperature recommended operating ranges, though may not be 100% parametrically tested in production.
4. The output current degrades at a rate of 8%/V.

TYPICAL CHARACTERISTICS

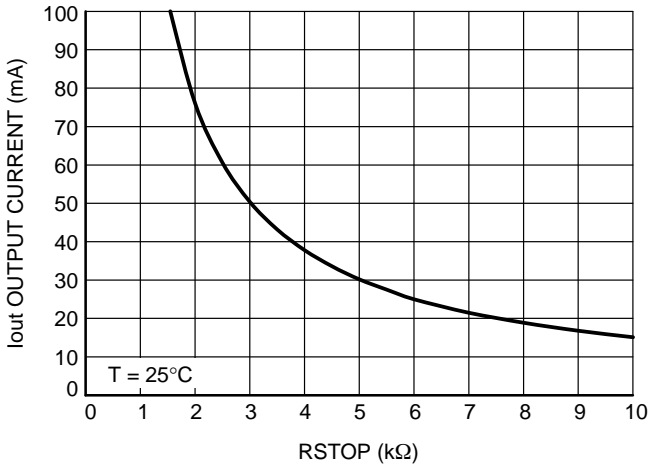

Figure 11. I<sub>out</sub> vs. R<sub>STOP</sub>

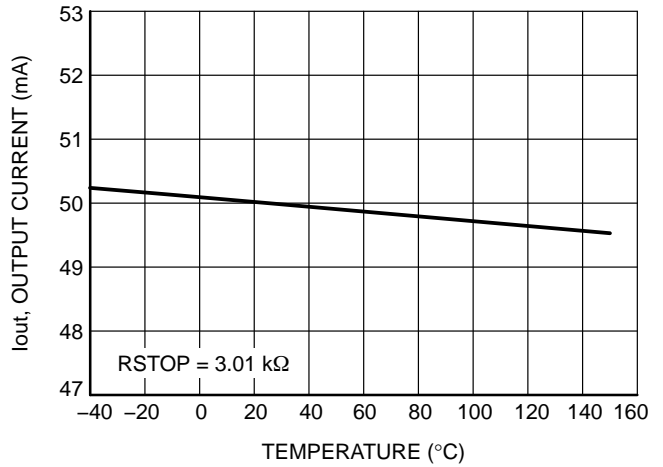

Figure 12. I<sub>out</sub> vs. Temperature

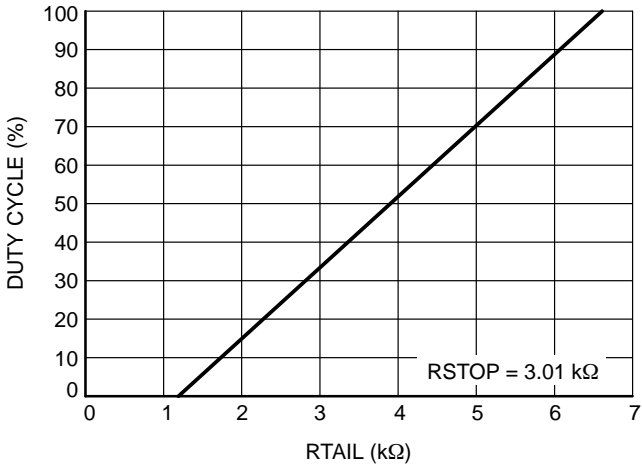

Figure 13. Duty Cycle vs. R<sub>TAIL</sub>

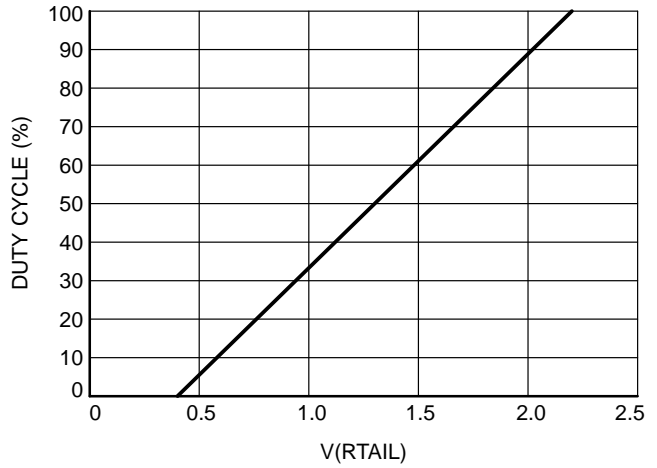

Figure 14. Duty Cycle vs. V(R<sub>TAIL</sub>)

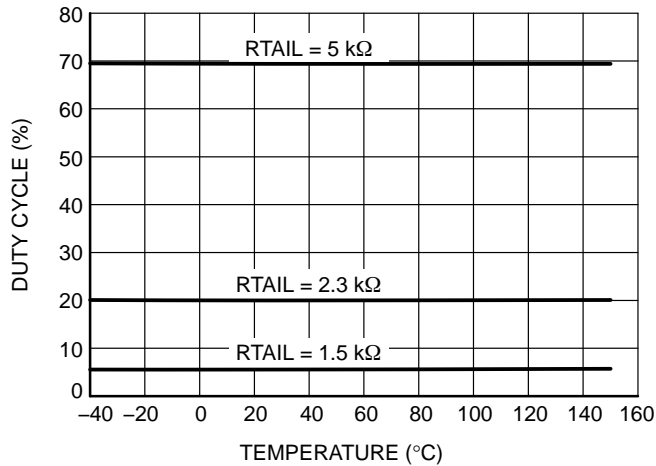

Figure 15. Duty Cycle vs. Temperature

TYPICAL CHARACTERISTICS

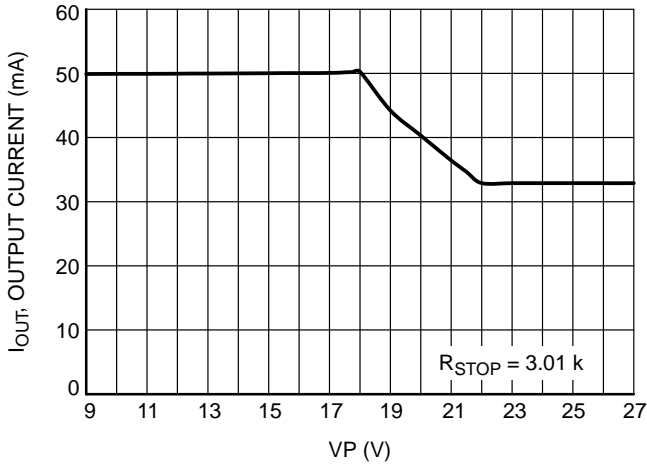

Figure 16. I<sub>OUT</sub> vs. V<sub>P</sub>

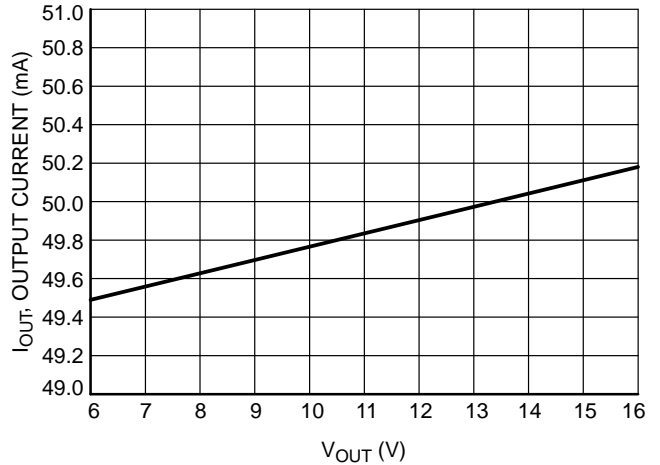

Figure 17. I<sub>OUT</sub> Line Regulation

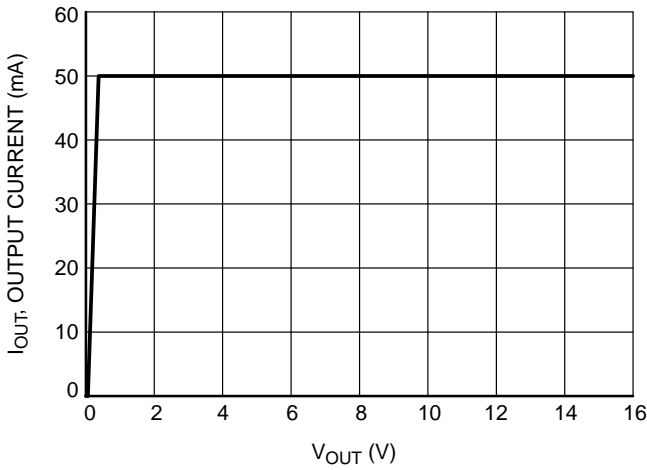

Figure 18. I<sub>OUT</sub> vs. V<sub>OUT</sub>

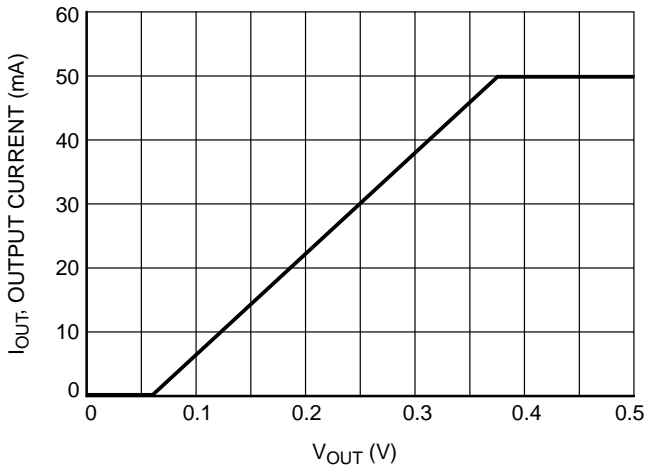

Figure 19. I<sub>OUT</sub> vs. V<sub>OUT</sub>

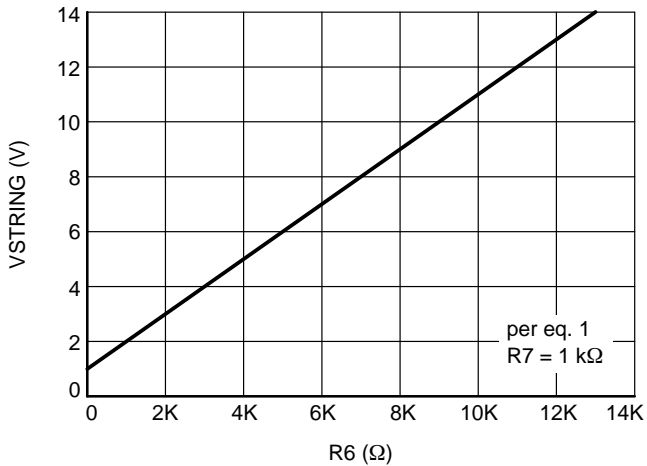

Figure 20. V<sub>STRING</sub> vs. R<sub>6</sub>

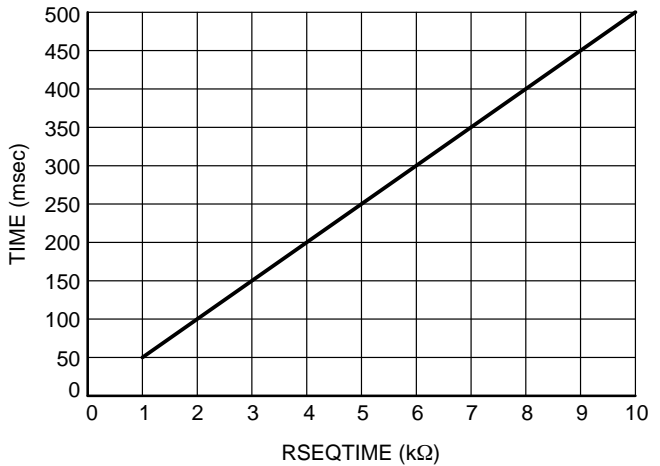

Figure 21. (Sequence Time / Re-Enable Time) vs. R<sub>SEQTIME</sub>

TYPICAL CHARACTERISTICS

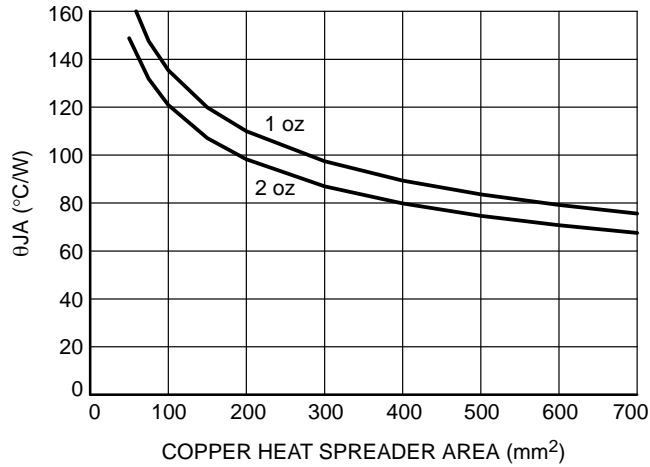

Figure 22.  $\theta_{JA}$  Copper Spreader Area

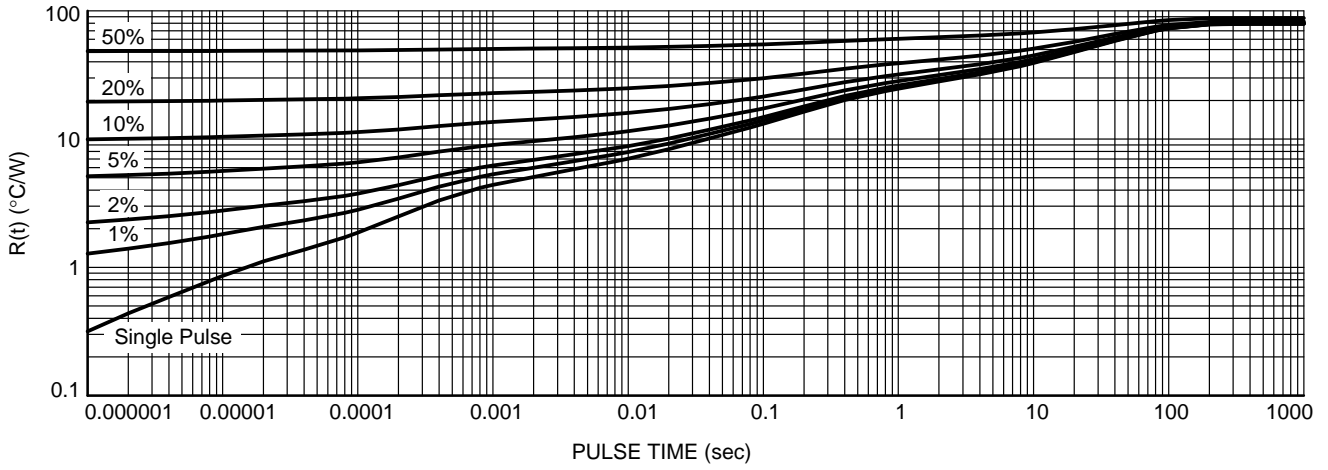

Figure 23. Thermal Duty Cycle Curves on 645  $\text{mm}^2$  Spreader Test Board

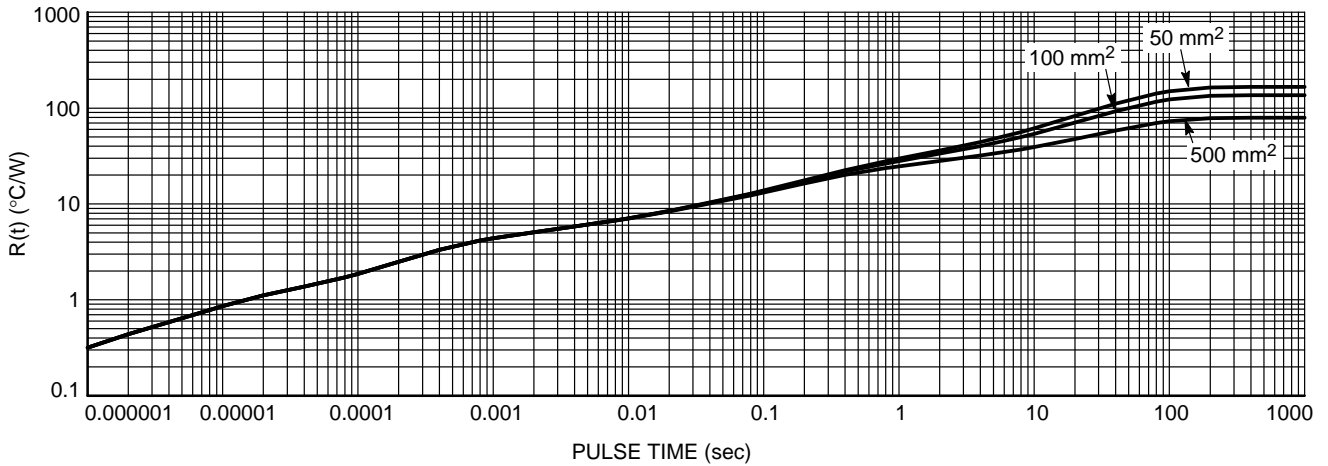

Figure 24. Single Pulse Heating Curve

DETAILED OPERATING DESCRIPTION

**General**

The NCV7683 device is an eight channel LED driver whose output currents up to 100 mA/channel are programmed by an external resistor. The target application for the device is in automotive Rear Combination Lighting (RCL) systems and blinking functions.

The STOP logic input switches the two modes of the IC. While in the STOP mode (high), the duty cycle of the outputs is at 100%. When STOP is low, the duty cycle of the outputs is programmed via an external resistor on the RTAIL pin.

A mixture of sequencing options is available using the Sequencing ON, SEQ1, and SEQ2 pins. Sequencing options include individual channels 1–8, 4 paired combinations, 2 quad combinations, and an all on delay. A logic output (DIAG) communicates open circuit of the LED driver outputs and SEQOUT back to the microprocessor. Both DIAG and SEQOUT require a pull-up resistor for proper operation.

An optional external control for a ballast transistor helps distribute the system power.

The part features an enable input logic pin.

**$\overline{LO}$  (Latch Off) and DIAG**

Automotive requirements sometime dictate all outputs turn off if one of the outputs is an open circuit. This eliminates driving with partial illuminated lights. The module will either display all LED strings or no LED strings at all. The option to turn all LED strings off with an open circuit detect on any of the 8 outputs is programmed by grounding the  $\overline{LO}$  pin. This pin should be left open if this feature is not required.

Each output has its own sensing circuitry. An open string detection on any output latches off all 8 outputs when programmed ( $\overline{LO}$  = low). There are three means to reinitiate the IC drivers.

1. Forcing the DIAG pin below the Open Circuit Reset Voltage (1.8 V typical).
2. Toggling the  $\overline{ENABLE}$  input
3. A complete power down of the device below the Under Voltage Lockout threshold including hysteresis (3.9 V typical).

**Open Load Detection**

Open load detection has an under voltage lockout feature to remove the possibility of turning off the device while it is powering up. The Open Load Disable Threshold is 7.7 V (typ). Open load detection becomes active above this threshold. Current is monitored internal to the NCV7683 device and an open load is flagged when the current is 1/2 of the targeted output current.

For multiple IC implementation of Open Load Detection and preservation of the Latch Off feature, multiple ballast transistors in series must be used as shown in Figure 25. Interruption of any of the series devices will provide an all off occurrence. The string voltage is set up by the feedback in just the first device. Any subsequent devices should connect their FB pin to ground. This will remove competition of voltage regulation points of Vstring.

# NCV7683

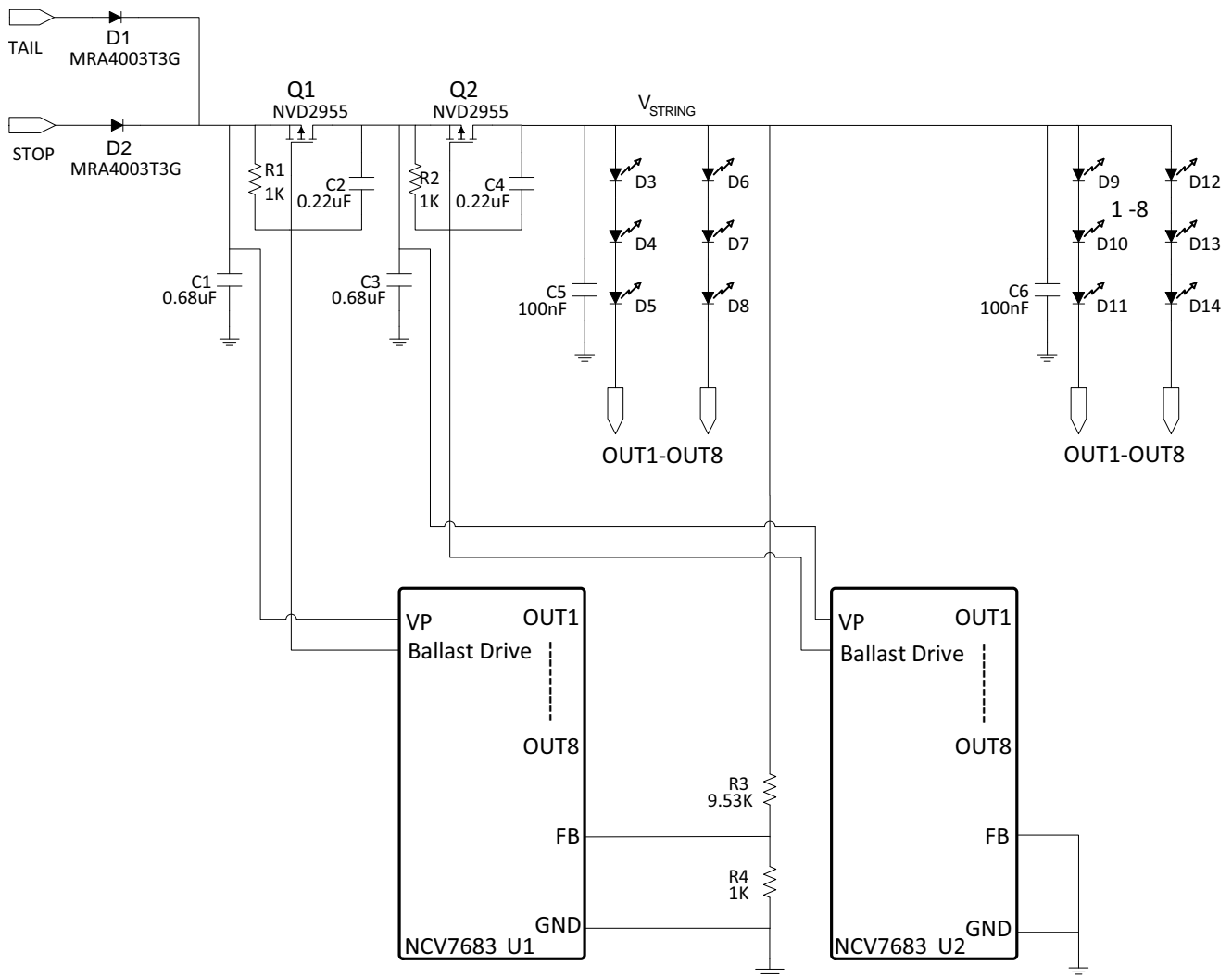

Figure 25.

## DIAG

The logic DIAG pins main function is to alert the controlling microprocessor an open string has occurred on one of the outputs (DIAG high = open string). Reference Table 1 for details on logic performance.

Open circuit conditions are reported when the outputs are actively driven. When operating in STOP mode the DIAG signal is a DC signal. When operating in TAIL the DIAG signal is a PWM signal reporting open circuit when the output drive is active.

## Ballast Drive

The use of an external FET device (NTD2955) helps distribute the system power. A DC voltage regulation system is used which regulates the voltage at the top (anode) of the LED strings ( $V_{string}$ ). This has the effect of limiting the power in the NCV7683 by setting the voltage on the IOUTx

pins specific to each customer application. The Ballast Drive pin provides the drive in the feedback loop from the FB pin. In steady state, the voltage is regulated at the feedback voltage (FB). A simple voltage divider helps set the voltage at  $V_{string}$ . Unlike other systems, the ballast drive current does not turn off in a leakage state when turned off (FB high), but instead provides 1 mA of current providing a faster response of the system loop. This sets the gate voltage of the NTD2955 to 1 V at 25°C.

## Parallel Outputs

The maximum rating per output is 100 mA. In order to increase system level LED string current, parallel combinations of any number of outputs is allowed. Combining all 8 outputs will allow for a maximum system level string current design of 800 mA.

**Unused Outputs**

Unused outputs should be shorted to ground. The NCV7683 detects the condition during power-up using the open load disable threshold and disables the open circuit detection circuitry. The timing diagrams below highlight the impacts in time with the sequencing function when an output is not used. In this example (Figures 26 and 27), OUT7 is not used and is grounded with SEQ1=0 and SEQ2=0. The

subsequent output (OUT8) has been pulled in (in time) as shown by the 1st arrow. The 2nd arrow shows the SEQOUT signal has also been pulled in (in time). For instances which are coupled with others (in time) (e.g. SEQ1=1 and SEQ2=0 with OUT7 GND), there is no change in the ensuing waveforms. Figure 27 shows there is no impact for channel 8 when OUT7 is not used.

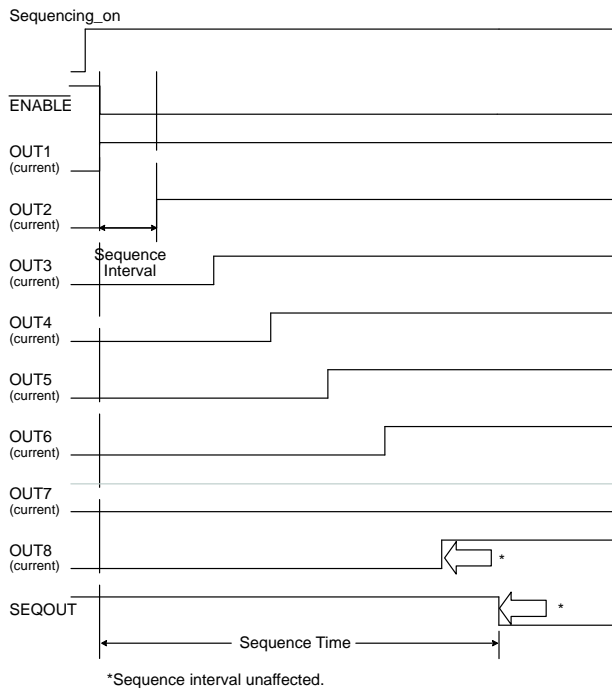

**Figure 26. Unused Output time shift. (SEQ1=0, SEQ2=0)**

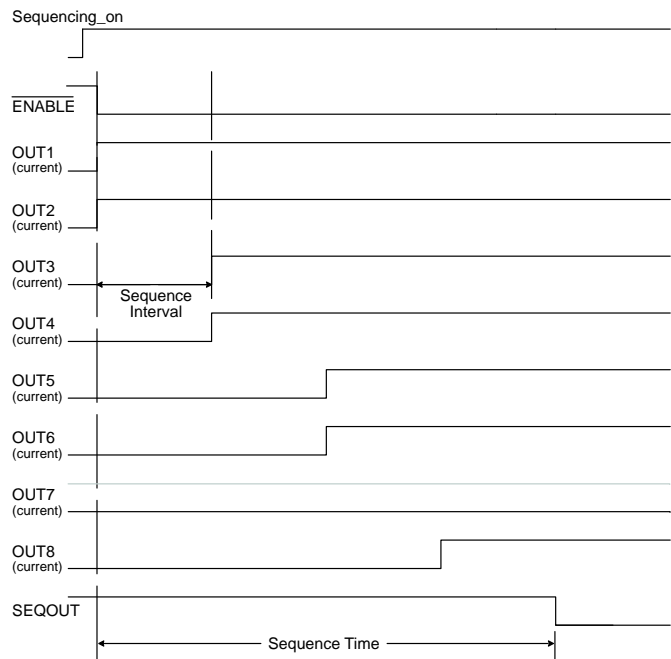

**Figure 27. Unused Output No Time Shift. (SEQ1=1, SEQ2=0)**

**Sequencing**

Output sequencing is controlled by the SEQON, SEQTIME, SEQ1, and SEQ2 pins. The SEQON pin must be high to enable any of the sequencing functions. With the SEQON pin in a low state, all 8 outputs turn on at the same time and SEQOUT remains high all the time (via the external pull-up resistor). The SEQ1 and SEQ2 programming pins are utilized by grounding them or leaving them floating. They follow Table 6 (reference timing diagrams in Figure 7, Figure 8, Figure 9, and Figure 10). The sequence interval is defined by the delay of the ENABLE pin going low to OUT2 turning on (OUT1 turns on coincident with ENABLE). The same sequence time interval is present for each additional sequential turn-on output of the IC.

Forcing an ENABLE high or SEQON low will cause a device which is operating in the sequence mode to leave the sequence mode. ENABLE going from low to high (Figure 28) will turn off all outputs. With SEQON going high to low (Figure 29 and Figure 30), operation will continue as a device which is not using the sequence mode feature. A device which was previously in TAIL mode

(STOP=0) (Figure 29) will revert to TAIL mode. A device which was previously in STOP mode (STOP=1) Figure 30 will revert to STOP mode.

Before a sequence event, SEQOUT is high impedance.  
After a sequence event, SEQOUT is high impedance.

**Sequence and Re-Enable Time Programming**

Sequence time is programmed using a resistor from the SEQTIME pin to ground. Figure 21 displays the expected time using the program resistor. Acceptable values for the resistor are between 1 K and 10 K. These provide 49 msec and 490 msec times respectively.

The Sequence Re-Enable Time uses the same internal timer as the Sequence Time. The Sequence Re-Enable Time is provided to prevent an immediate feedback triggering in a daisy chain setup. Reference Figures 33 and Figure 36 for details.

The program resistor used can be calculated by using the electrical parameters

1. Sequence Time / R<sub>SEQTIME</sub>
2. Sequence Re-Enable Time / R<sub>SEQTIME</sub>

$$\text{Sequence Time} = \frac{\text{Sequence\_Time}}{R_{\text{SEQTIME}}} \cdot R_{\text{SEQTIME}}$$

$$\text{Sequence ReEnable\_Time} = \frac{\text{Sequence ReEnable\_Time}}{R_{\text{SEQTIME}}} \cdot R_{\text{SEQTIME}}$$

**Table 6. SEQUENCING COMBINATIONS**

SEQ1	SEQ2	Sequencing Functionality
1	1	All On
1	0	Dual Output Combination
0	1	Quad Combination
0	0	Full 8 Channel Sequencing

0 = ground  
 1 = floating\*  
 SEQON = 1

\*Internal pull-up to the internal power supply.

Example:

Electrical Parameter (typ)  
 Sequence Time / R<sub>SEQTIME</sub> = 49 msec/kΩ  
 R<sub>SEQTIME</sub> = 1 kΩ  
 Sequence Time = 49 \* 1 = 49 msec

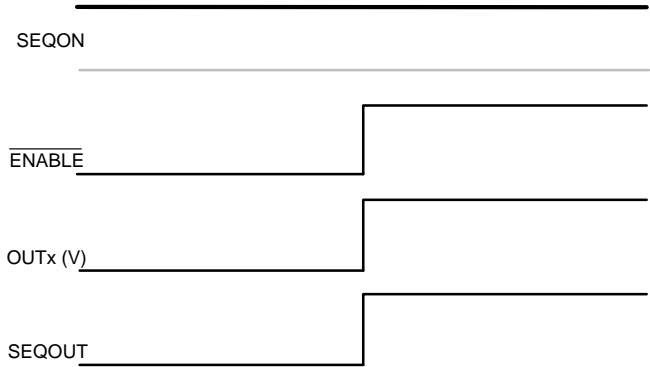

**Figure 28. Sequence Interrupt from  $\overline{\text{EN}}$**

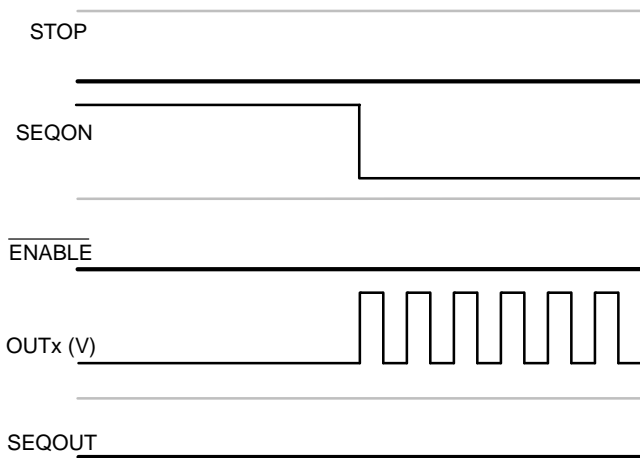

**Figure 29. Sequence Interrupt from SEQON (STOP=0)**

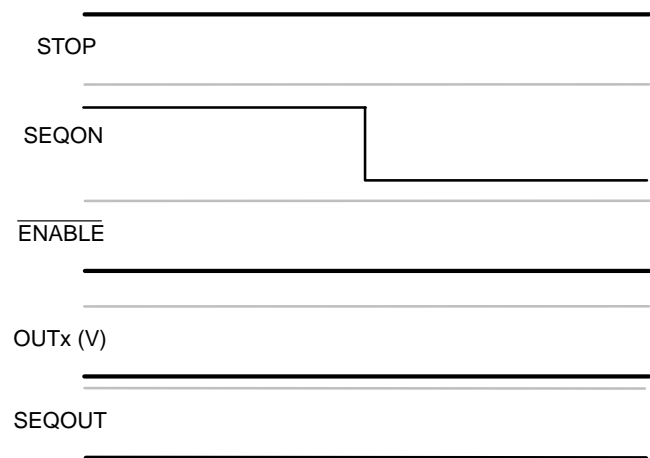

**Figure 30. Sequence Interrupt from SEQON (STOP=1)**

**Daisy Chain**

NCV7683 devices can be daisy-chained as shown in Figure 32. Connections allow for a continuous stream of devices including all delays attributed to the previous sequence timing events from the previous integrated circuits. This setup ripples the signal through all devices until all devices are on. The example shows 3 devices, but as many devices as desired may be used.

For retriggerable functionality such that once a signal reaches the end of the daisy chain string, all devices turn off, and the sequence starts again refer to Figure 33 or Figure 35. The NCV7683 device utilizes a Sequence Re-Enable time whereby a device turned off via the  $\overline{\text{ENABLE}}$  pin will not turn back on until the Sequence Re-Enable time has passed. This allows all devices to turn off for a discernible time before reinitiating the sequence. Additional time at the end

of the sequence can be achieved through the use of an optional capacitor. If the optional capacitor does not provide sufficient time at the end of the sequence, an NCV303 Voltage Detector can be added as shown in Figure 34.

Figure 36 shows the timing diagram associated with the setup shown in Figure 33. As each NCV7683 device receives a turn on signal through its  $\overline{\text{ENABLE}}$  pin, the output turns on an LED. There is an internal delayed response for the SEQOUT pin to go low which delays the turn-on of the next sequential LED. An alternative setup using NFET transistors instead of PFET transistors is shown in Figure 35.

An open circuit detection circuit is implemented (refer to Figure 31) on the SEQOUT pin to enable the detection of the condition (open circuit), report the condition back to the



# NCV7683

controller via the DIAG pin, and turn off all driver ICs in the daisy chain eliminating any spurious lighting events.

SEQOUT is not active during STOP/TAIL modes (SEQOUT=0).

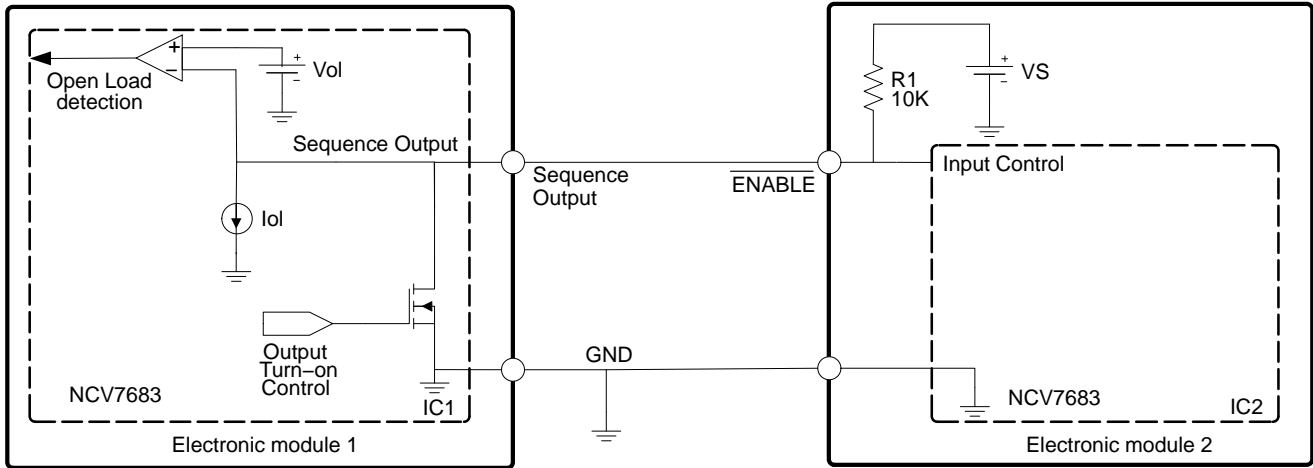

Figure 31. Daisy Chain Interface between Multiple ICs

Table 7. APPLICATION SPECIFIC TRUTH TABLE

Input				Fault State		SEQOUT	Current Sources Status
ENB	SEQON	STOP	LO	Condition	DIAG		
<b>OFF</b>							
1	X	X	X	X	1	Hi Z	ALL OFF
<b>TURN</b>							
0	1	X	X	NORMAL	0	ACTIVE	SEQUENCING
0	1	X	X	BIAS ERROR	1	ACTIVE	SEQUENCING
0	1	X	OPEN	OPEN CIRCUIT	1	ACTIVE	SEQUENCING
0	1	X	X	TSD	1	Hi Z	ALL OFF
0	1	X	SHORT TO GROUND	OPEN CIRCUIT	1	Hi Z	ALL OFF
0	1	X	X	SEQOUT OPEN	1	Hi Z	SEQUENCING
<b>STOP</b>							
0	0	1	X	NORMAL	0	0	ALL ON
0	0	1	X	BIAS ERROR	1	0	ALL ON
0	0	1	OPEN	OPEN CIRCUIT	1	0	ALL ON
0	0	1	X	TSD	1	0	ALL OFF
0	0	1	SHORT TO GROUND	OPEN CIRCUIT	1	0	ALL OFF
<b>TAIL</b>							
0	0	0	X	NORMAL	0	0	ALL PWM
0	0	0	X	BIAS ERROR	1	0	ALL PWM
0	0	0	OPEN	OPEN CIRCUIT	PWM	0	ALL PWM
0	0	0	X	TSD	1	0	ALL OFF
0	0	0	SHORT TO GROUND	OPEN CIRCUIT	1	0	ALL OFF

BIAS ERROR = 20% current foldback (via overvoltage on VP and/or over temperature) or RSTOP current limit.

# NCV7683

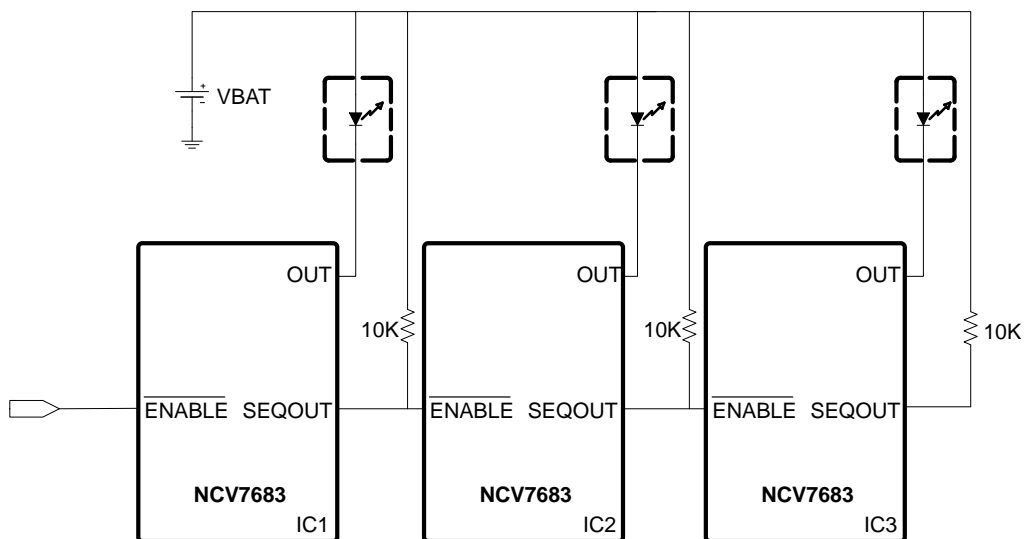

Figure 32. Daisy Chain Sequencing

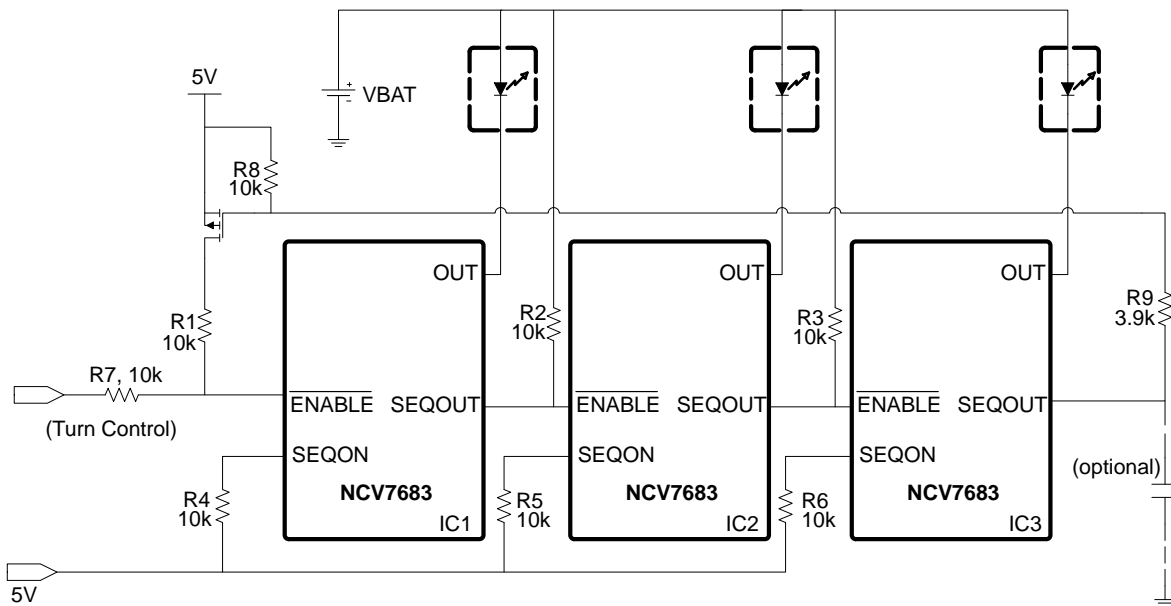

Figure 33. Retriggerable Daisy Chain Sequencing using the Sequence Re-Enable Time

# NCV7683

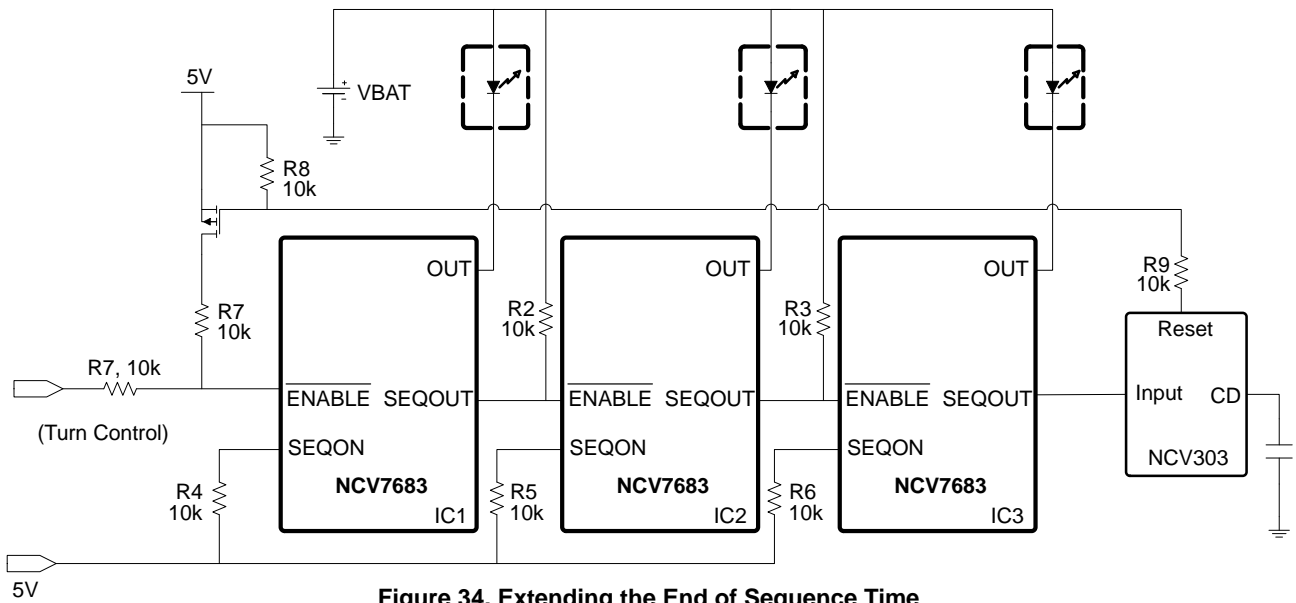

Figure 34. Extending the End of Sequence Time

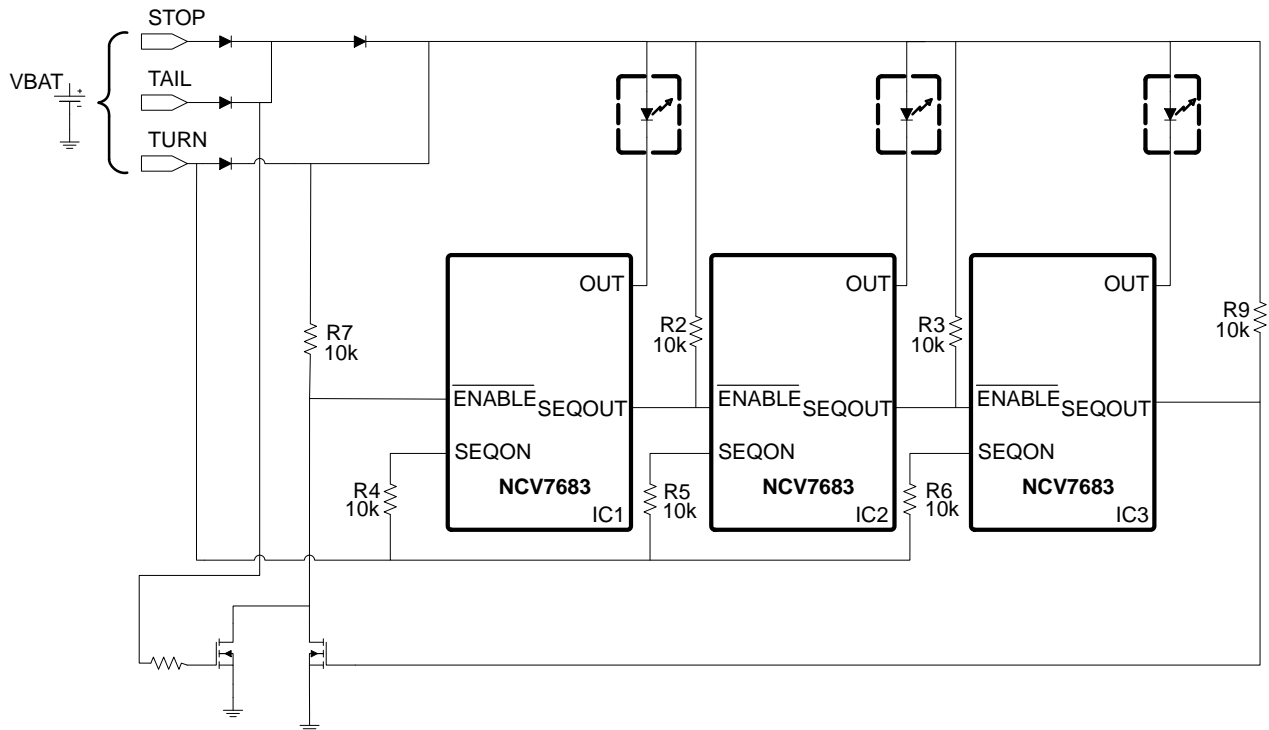

Figure 35. Alternate Retriggerable Daisy Chain Sequencing using Sequence Re-Enable Time

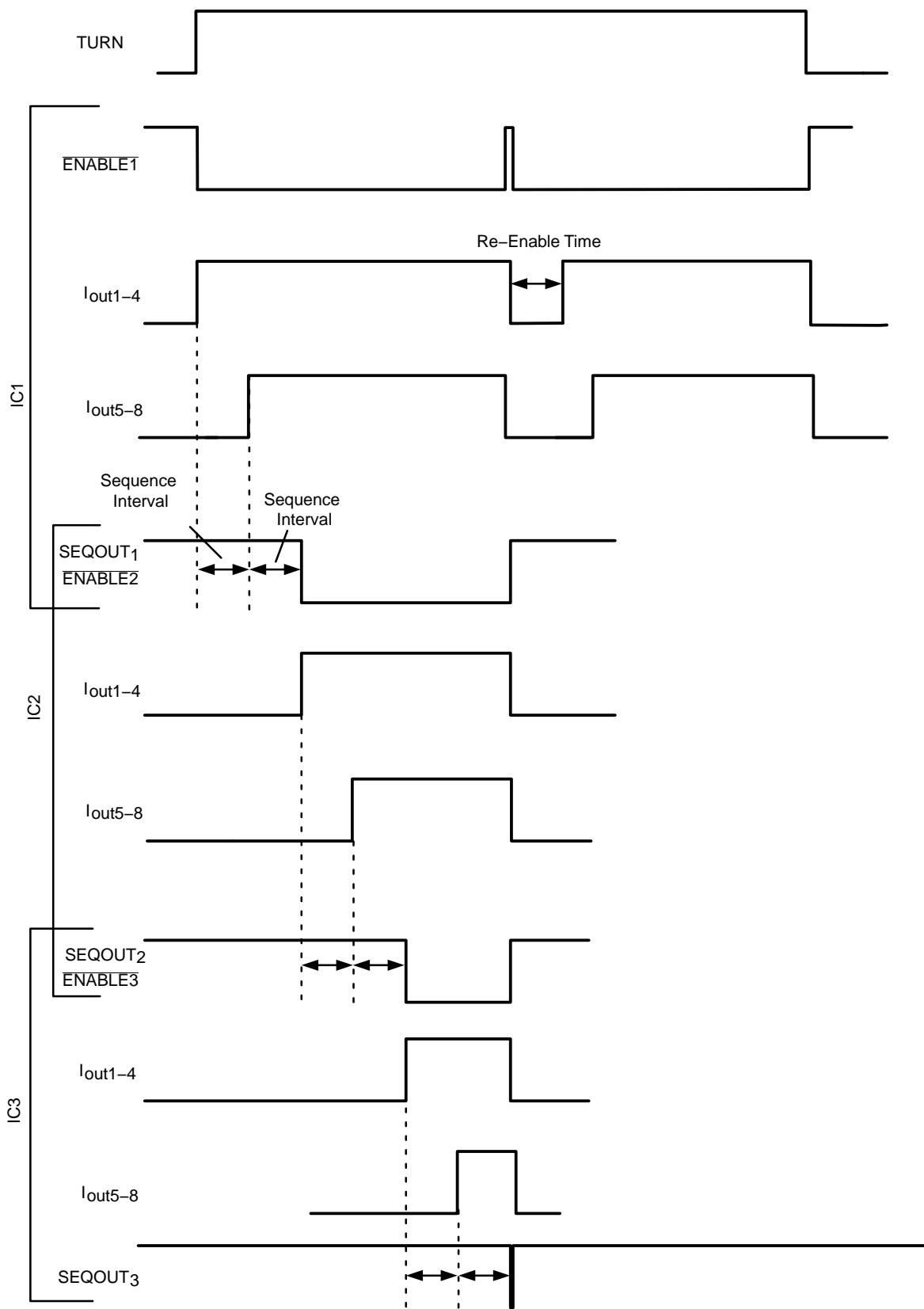

Figure 36. Sequencing Timing Diagram with Re-Enable Time Delay

**Programmability**

Strings of LEDs are a common configuration for RCL applications. The NCV7683 provides eight matched outputs allowing individual string drive with current set by a single resistor. Output currents are mirrored and matched within ±4% at hot temperature.

A high STOP condition sets the output current using equation 1 below.

A low STOP condition, modulates the output currents at a duty cycle (DC) programmed using equation 2 below.

Note, current limiting on RSTOP limits the current which can be referenced from the RSTOP Pin. Exceeding the RSTOP Current Limit will set the output current to less than 100 mA, and the DIAG Pin will go high. This helps limit output current (brightness and power) for this type of fault.

The average ISTOP Duty Cycle current provides the dimmed tail illumination function and assures a fixed brightness level for tail. The PWM generator’s fixed frequency (800 Hz typ.) oscillator allows flicker-free illumination. PWM control is the preferred method for dimming LEDs.

The diagnostic function allows the detection of an open in any one of the output circuits. The active-low diagnostic output (DIAG) is coincident with the STOP input and the ON state in the tail mode. DIAG remains high (pulled up) if an open load is detected in any LED string when STOP is high.

**Output Current Programming**

Reference Figure 11 (typ performance graph) to choose programming resistor (RSTOP) value for stop current. Reference Figure 13 Typical Performance Graph (Duty Cycle vs. RTAIL) to choose a typical value programming resistor for output duty cycle (with a typical RSTOP value of 3.01 kΩ). Note the duty cycle is dependent on both RSTOP and RTAIL values. RSTOP should always be chosen first as the stop current is only dependent on this value.

Alternatively, the equations below can be used to calculate a typical value and used for worst case analysis.

Set the Stop Current using RSTOP

$$I_{OUTX} = 150 \cdot \frac{RSTOP\_Bias\_Voltage}{RSTOP} \quad (eq. 1)$$

RSTOP Bias Voltage = 1 V (typ)

**Set the Duty Cycle (DC) using RTAIL**

$$RTAIL = 1.8 \cdot RSTOP(DC + 0.22) \quad (eq. 2)$$

DC = duty cycle expressed in fractional form. (e.g. 0.50 is equivalent to 50% duty cycle) (ground RTAIL when using external modulation)

Output Current is directly tested per the electrical parameter table to be ±10% (with RSTOP = 3.01 KΩ) or 45 mA (min), 50 mA (typ), 55 mA (max) at room and hot temperature.

Duty Cycle will vary according to the changes in RTAIL Voltage and RTAIL Bias Current (generated from the current through RSTOP).

Voltage errors encompass generator errors (0.4 V to 2.2 V) and comparator errors and are included in testing as the Duty Cycle. Typical duty cycle measurements are 5% with RTAIL = 0.49 V and 70% with RTAIL = 1.66 V.

RTAIL Bias Current errors are measured as RTAIL Bias Current and vary as 290 μA (min), 330 μA (typ), and 370 μA (max) with RSTOP = 3.01 kΩ.

The error duality originating from both the internal current source generated on the RSTOP pin and the comparator voltage thresholds of the RTAIL pin combined with the choice of duty cycle levels make it difficult to specify duty cycle minimum and maximum limits, but worst case conditions can be calculated when considering the variation in the voltage threshold and current source. Duty Cycle variation must include the direct duty cycle as specified in the electrical parameter table plus an additional error due to the Istop current which generates this voltage in the system.

**RSTOP Over Current Protection**

Over Current protection has been included for the RSTOP pin. Without protection, the device performance could cause excessive high current and potential damage to the external LEDs. Detection of the RSTOP over current event (RSTOP to ground) is 1 mA (typ) and is current limited to 2.2 mA (typ). Output drive currents will limit to typically 65 mA.

Note – A feature of the NCV7683 device includes operation of the device during a short circuit on the RSTOP pin. Iout is decreased during the STOP condition and the TAIL duty cycle is reduced to less than 40% by reducing the voltage on the RTAIL pin to 2/3 of normal operation.

**Set Back Current**

Automotive battery systems have wide variations in line supply voltage. Low dropout is a key attribute for providing consistent LED light output at low line voltage. Unlike adjustable regulator based constant current source schemes where the set point resistor resides in the load path, the NCV7683’s set point resistor lies outside the LED load path, and aids in the low dropout capability.

Setback Current Limit is employed during high voltage. During a Setback Current Limit event, the drive current is reduced resulting in lower power dissipation on the IC. This occurs during high battery voltage (VP > 16 V). In this way the NCV7683 can operate in extreme conditions and still provide a controlled level of light output The Setback Current (–20%) condition is reported on the DIAG Pin.

Activation of the set back current feature provides a roll-off rate of –8%/V.

# MECHANICAL CASE OUTLINE

## PACKAGE DIMENSIONS

ON Semiconductor®



SSOP24 NB EP  
CASE 940AP  
ISSUE O

DATE 05 MAR 2015

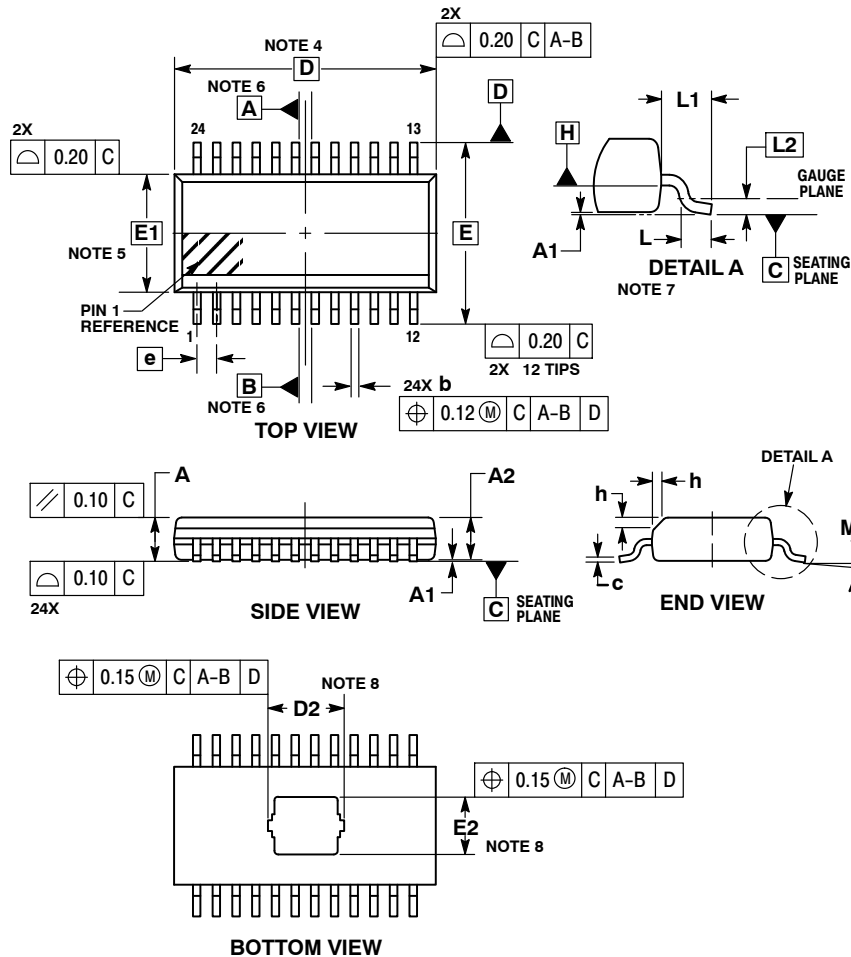

NOTES:

1. DIMENSIONING AND TOLERANCING PER ASME Y14.5M, 1994.
2. CONTROLLING DIMENSION: MILLIMETERS.
3. DIMENSION **b** DOES NOT INCLUDE DAMBAR PROTRUSION. DAMBAR PROTRUSION SHALL BE 0.10 MAX. AT MMC. DAMBAR CANNOT BE LOCATED ON THE LOWER RADIUS OF THE FOOT. DIMENSION **b** APPLIES TO THE FLAT SECTION OF THE LEAD BETWEEN 0.10 TO 0.25 FROM THE LEAD TIP.
4. DIMENSION **D** DOES NOT INCLUDE MOLD FLASH, PROTRUSIONS OR GATE BURRS. MOLD FLASH, PROTRUSIONS OR GATE BURRS SHALL NOT EXCEED 0.15 PER SIDE. DIMENSION **D** IS DETERMINED AT DATUM PLANE **H**.
5. DIMENSION **E1** DOES NOT INCLUDE INTERLEAD FLASH OR PROTRUSION. INTERLEAD FLASH OR PROTRUSION SHALL NOT EXCEED 0.25 PER SIDE. DIMENSION **E1** IS DETERMINED AT DATUM PLANE **H**.
6. DATUMS **A** AND **B** ARE DETERMINED AT DATUM PLANE **H**.
7. **A1** IS DEFINED AS THE VERTICAL DISTANCE FROM THE SEATING PLANE TO THE LOWEST POINT ON THE PACKAGE BODY.
8. CONTOURS OF THE THERMAL PAD ARE UNCONTROLLED WITHIN THE REGION DEFINED BY DIMENSIONS **D2** AND **E2**.

MILLIMETERS		
DIM	MIN	MAX
<b>A</b>	---	1.75
<b>A1</b>	0.00	0.10
<b>A2</b>	1.10	1.65
<b>b</b>	0.19	0.30
<b>c</b>	0.09	0.20
<b>D</b>	8.64 BSC	
<b>D2</b>	2.37	2.67
<b>E</b>	6.00 BSC	
<b>E1</b>	3.90 BSC	
<b>E2</b>	1.79	1.99
<b>e</b>	0.65 BSC	
<b>h</b>	0.25	0.50
<b>L</b>	0.40	0.85
<b>L1</b>	1.00 REF	
<b>L2</b>	0.25 BSC	
<b>M</b>	0°	8°

GENERIC MARKING DIAGRAM\*



- XXXX = Specific Device Code
- A = Assembly Location
- WL = Wafer Lot
- YY = Year
- WW = Work Week
- G = Pb-Free Package

(Note: Microdot may be in either location)

\*This information is generic. Please refer to device data sheet for actual part marking. Pb-Free indicator, "G" or microdot "•", may or may not be present. Some products may not follow the Generic Marking.

RECOMMENDED SOLDERING FOOTPRINT

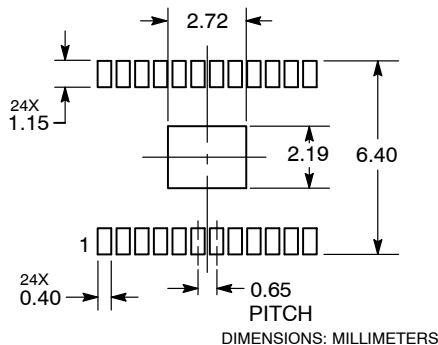

DOCUMENT NUMBER:	98AON96176F	Electronic versions are uncontrolled except when accessed directly from the Document Repository. Printed versions are uncontrolled except when stamped "CONTROLLED COPY" in red.
DESCRIPTION:	SSOP24 NB EP	PAGE 1 OF 1

ON Semiconductor and ON are trademarks of Semiconductor Components Industries, LLC dba ON Semiconductor or its subsidiaries in the United States and/or other countries. ON Semiconductor reserves the right to make changes without further notice to any products herein. ON Semiconductor makes no warranty, representation or guarantee regarding the suitability of its products for any particular purpose, nor does ON Semiconductor assume any liability arising out of the application or use of any product or circuit, and specifically disclaims any and all liability, including without limitation special, consequential or incidental damages. ON Semiconductor does not convey any license under its patent rights nor the rights of others.

ON Semiconductor and  are trademarks of Semiconductor Components Industries, LLC dba ON Semiconductor or its subsidiaries in the United States and/or other countries. ON Semiconductor owns the rights to a number of patents, trademarks, copyrights, trade secrets, and other intellectual property. A listing of ON Semiconductor's product/patent coverage may be accessed at [www.onsemi.com/site/pdf/Patent-Marking.pdf](http://www.onsemi.com/site/pdf/Patent-Marking.pdf). ON Semiconductor reserves the right to make changes without further notice to any products herein. ON Semiconductor makes no warranty, representation or guarantee regarding the suitability of its products for any particular purpose, nor does ON Semiconductor assume any liability arising out of the application or use of any product or circuit, and specifically disclaims any and all liability, including without limitation special, consequential or incidental damages. Buyer is responsible for its products and applications using ON Semiconductor products, including compliance with all laws, regulations and safety requirements or standards, regardless of any support or applications information provided by ON Semiconductor. "Typical" parameters which may be provided in ON Semiconductor data sheets and/or specifications can and do vary in different applications and actual performance may vary over time. All operating parameters, including "Typicals" must be validated for each customer application by customer's technical experts. ON Semiconductor does not convey any license under its patent rights nor the rights of others. ON Semiconductor products are not designed, intended, or authorized for use as a critical component in life support systems or any FDA Class 3 medical devices or medical devices with a same or similar classification in a foreign jurisdiction or any devices intended for implantation in the human body. Should Buyer purchase or use ON Semiconductor products for any such unintended or unauthorized application, Buyer shall indemnify and hold ON Semiconductor and its officers, employees, subsidiaries, affiliates, and distributors harmless against all claims, costs, damages, and expenses, and reasonable attorney fees arising out of, directly or indirectly, any claim of personal injury or death associated with such unintended or unauthorized use, even if such claim alleges that ON Semiconductor was negligent regarding the design or manufacture of the part. ON Semiconductor is an Equal Opportunity/Affirmative Action Employer. This literature is subject to all applicable copyright laws and is not for resale in any manner.

## PUBLICATION ORDERING INFORMATION

### LITERATURE FULFILLMENT:

Email Requests to: [orderlit@onsemi.com](mailto:orderlit@onsemi.com)

ON Semiconductor Website: [www.onsemi.com](http://www.onsemi.com)

### TECHNICAL SUPPORT

North American Technical Support:  
Voice Mail: 1 800-282-9855 Toll Free USA/Canada  
Phone: 011 421 33 790 2910

Europe, Middle East and Africa Technical Support:

Phone: 00421 33 790 2910

For additional information, please contact your local Sales Representative