

Schematic for the NCP702MX33TCGEVB Evaluation Board

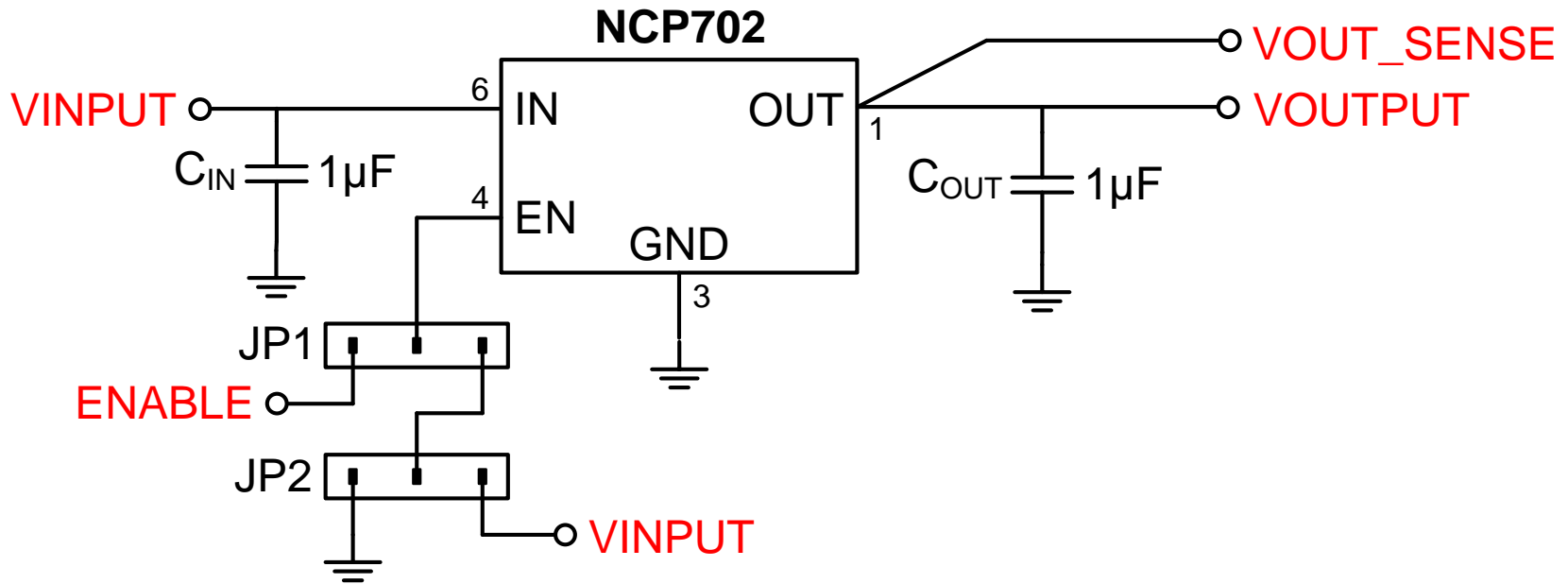

NCP702, 200mA, Ultra-Low Noise LDO Schematic