

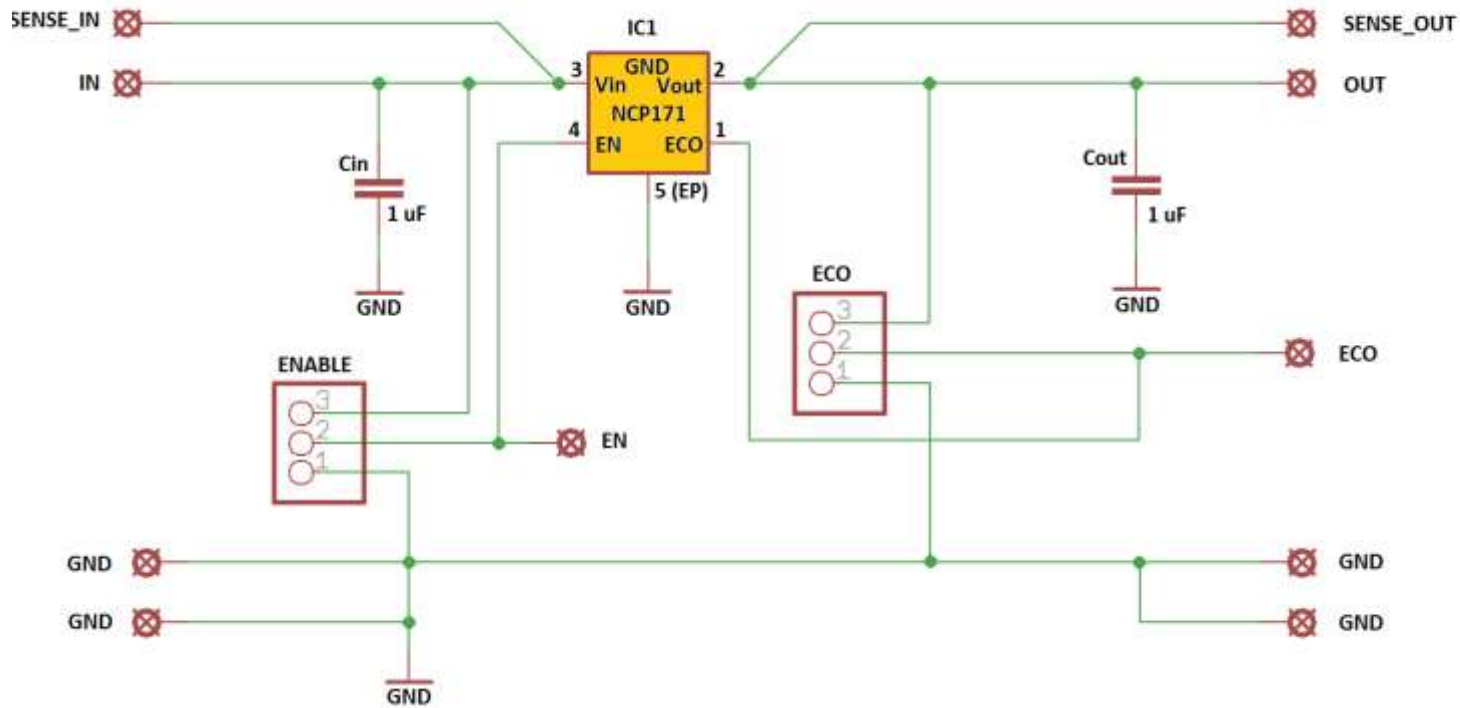

ON Semiconductor

## Schematic for the NCP171AMX170165TCG LDO Demoboard



### Programming I/F

