

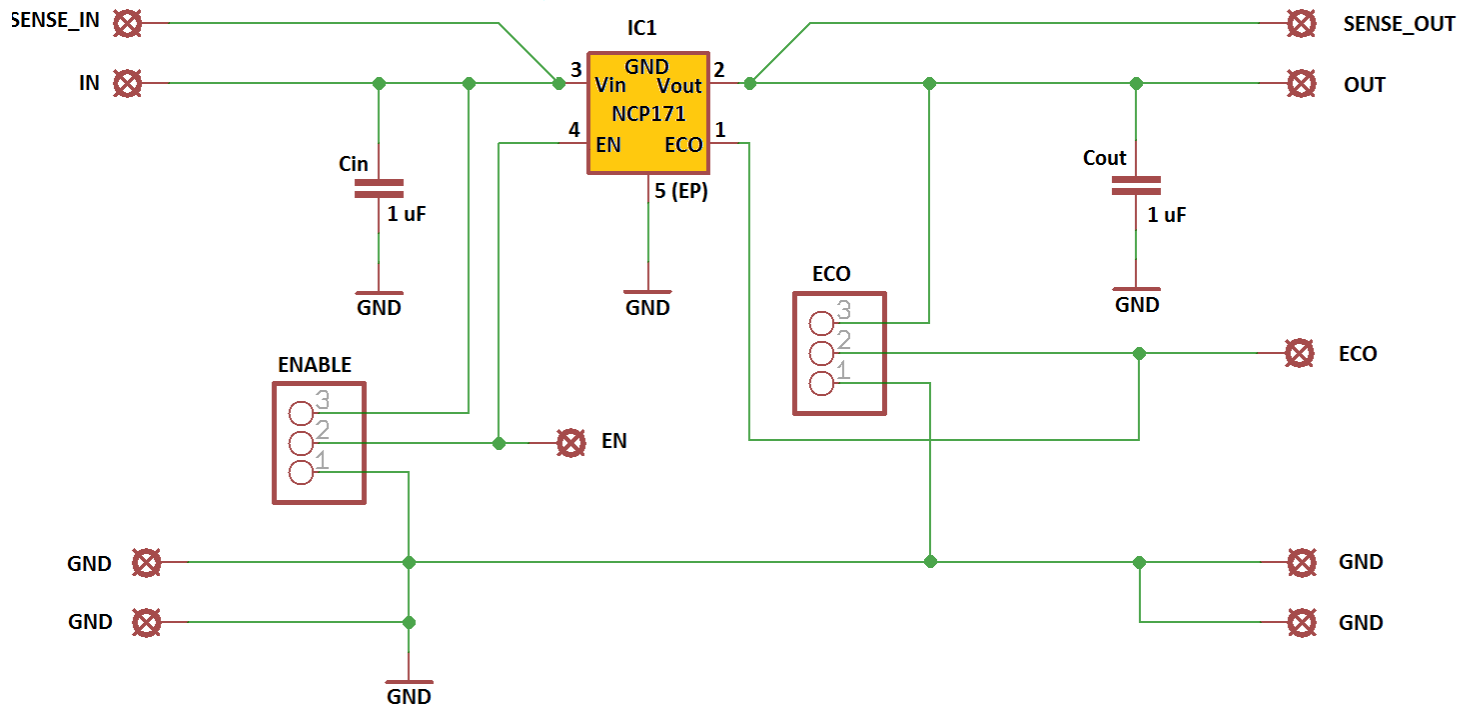

ON Semiconductor

Schematic for the NCP171AMX080060TCG LDO Demoboard



Programming I/F

