

Schematic for the NCP170AXV360GEVB Evaluation Board

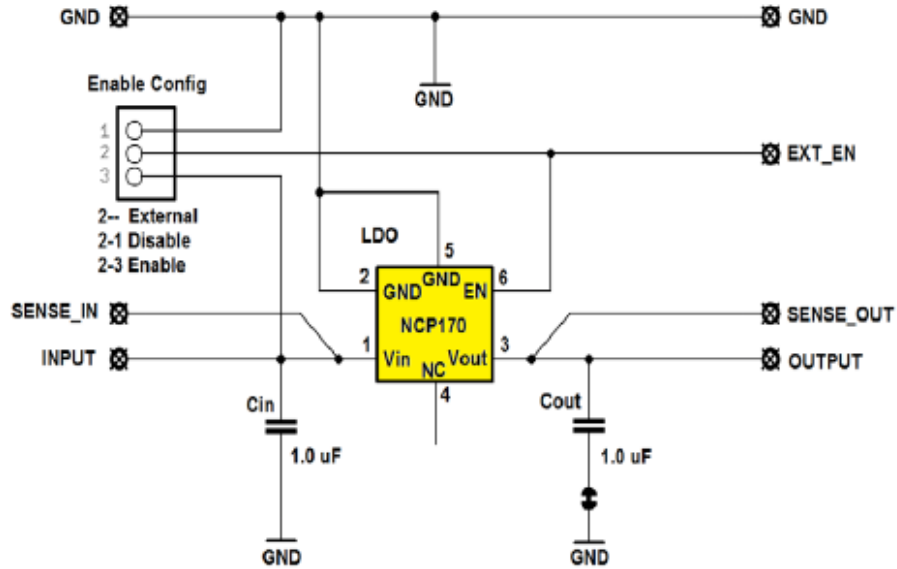

Programming I/F

