

Schematic for the NCP170AMX300GEVB Evaluation Board

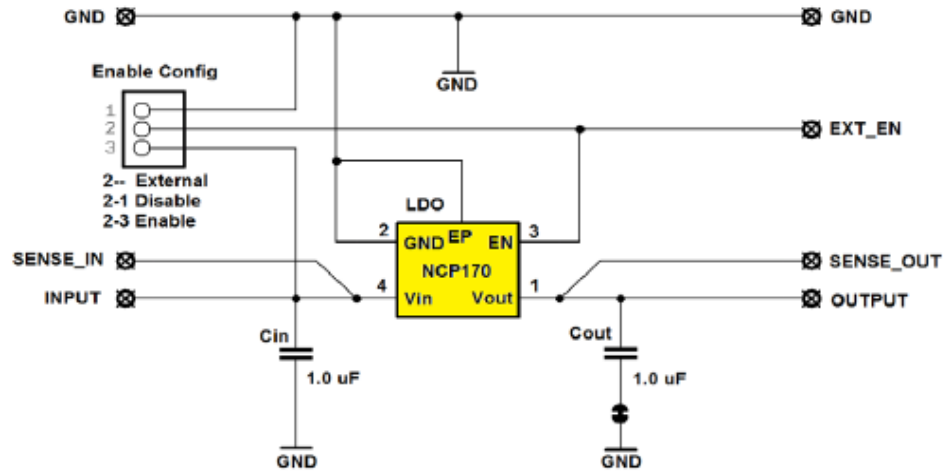

Programming I/F

