

Schematic for the NCP170AMX250GEVB Evaluation Board

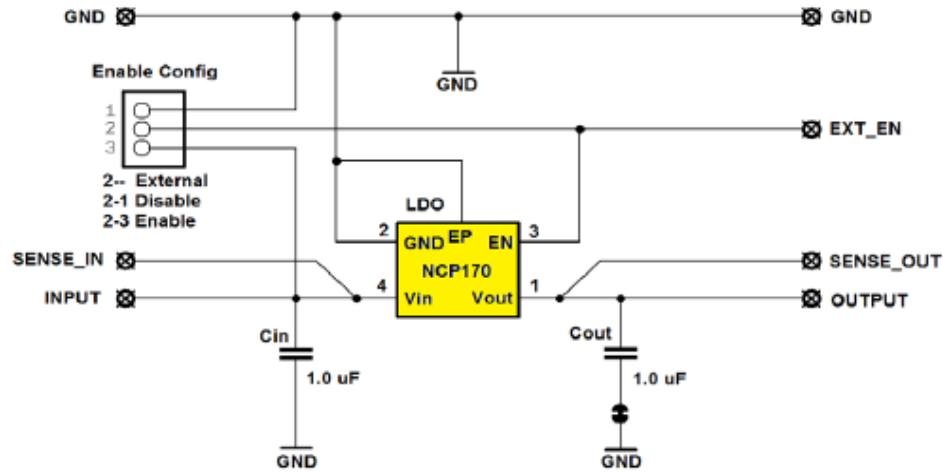

Programming I/F

