

Schematic for the NCP170AMX120GEVB Evaluation Board

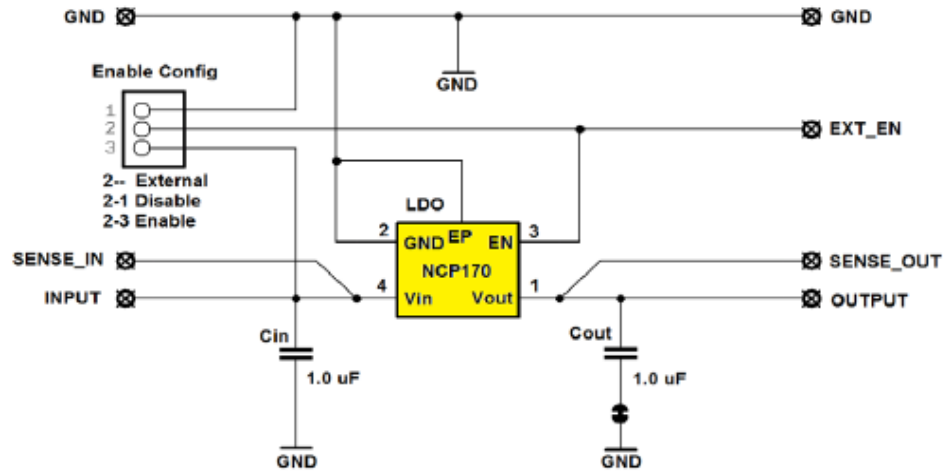

Programming I/F

