



Test Procedure for the NCP1654PFCGEVB Evaluation Board

Test Equipments Setup (refer to Figure 1)

1. Apply a 500 Ω / above 400 W resistive load (or use a set of resistors placed in parallel) across the output (between the "+V_{OUT}" and "-V_{OUT}" TB2 terminals of the board) via 2 power switches, SW1 and SW2.
2. Apply a 3 k Ω / 400 W resistor load in parallel with above 500 Ω load via another power switch, SW3.
3. Apply one isolated ac power source which power range is above 500 VA to the TB1 of NCP1654 demo board through the power meter.
4. Place a power meter, e.g. WT210 from YAKOGOWA, to measure:
 - The power delivered by the power source ("Pin"),
 - The power factor ("PF") and the Total Harmonic Distortion ("THD") of the current absorbed from the ac power source.
5. Supply the controller by applying 15 V to the V_{CC} socket (between the "+12 V" and "GND" TB3 terminals of the board).
6. Use one oscilloscope to measure:
 - The output voltage of NCP1654 demo board (between the "+V_{OUT}" and "-V_{OUT}" TB2 terminals of the board) by one high voltage probe.
 - The input current of NCP1654 demo board by one isolated current probe.

Test 1: Start up at low line, full load

Test conditions:

1. SW1 and SW2 close, SW3 open. (output load is full load)
2. AC input: 85 Vac, 60 Hz
3. Use 15 V dc source applied to TB3 to enable the operation.

Test criteria:

- V_{OUT} should be in the range from 378 V to 401 V.
- Input current should be sinusoidal without distortion (refer to Ch4 shown in Figure 2), which is measured by oscilloscope.
- PF > 0.99
- THD < 10%

Test 2: PF, THD, Efficiency at 110 Vac, full load

Test conditions:

1. SW1 and SW2 close, SW3 open. (output load is full load)
2. AC input: 110 Vac, 60 Hz
3. Use 15 V dc source applied to TB3 to enable the operation.

Test criteria:

- V_{OUT} should be in the range from 378 V to 401 V.
- PF > 0.99
- THD < 10%
- Efficiency > 94 %.

Test 3: PF, THD, Efficiency at 230 Vac, full load

Test conditions:

1. SW1 and SW 2 close, SW3 open (output load is full load)
2. AC input: 230 Vac, 50 Hz
3. Use 15 V dc source applied to TB3 to enable the operation.

Test criteria:

- V_{OUT} should be in the range from 378 V to 401 V.
- PF > 0.98
- THD < 10%
- Efficiency > 97 %.

**Test 4: Over Current Limitation at 85 Vac**

Test conditions:

1. SW1 and SW 2 close, SW3 open for start up. (output load is full load)
2. AC input: 85 Vac, 60 Hz
3. Use 15 V dc source applied to TB3 to enable the operation.
4. After start up, close SW3 to see the behavior of over-current limitation.

Test criteria:

- The input current should be limited (refer to Ch4 of Figure 3)

Test 5: Transient Response at 85 Vac

Test conditions:

5. SW1 and SW3 open. SW 2 close. (output load is no load)
6. AC input: 85 Vac, 60 Hz
7. Use 15 V dc source applied to TB3 to enable the operation.
8. Measure V_{OUT} by oscilloscope when closing SW1, i.e. change the output load from 0 A to full load.

Test criteria:

- V_{OUT} should be above 300 V (refer to Ch2 of Figure 4)

Test 6: Over-Voltage Protection

Test conditions:

1. SW1 and SW 2 close. SW3 open. (output load is full load)
2. AC input: 85 Vac, 60 Hz
3. Use 15 V dc source applied to TB3 to enable the operation.
4. Measure V_{OUT} by oscilloscope at start up, i.e. start up at full load.

Test criteria:

- V_{OUT} should be below 420 V (refer to Ch2 of Figure 5)

Test 7: Brown-Out Recovery

Test conditions:

1. SW1 and SW 3 close. SW2 open (output load is around 0.13 A)
2. AC input: 60 Vac, 60 Hz
3. Use 15 V dc source applied to TB3 to enable the operation.
4. Measure V_{OUT} by oscilloscope. Set the triggering level at about 200 V (rising edge), the trigger position being set at 30% of the screen. Program the scope to observe 40 ms around in single acquisition mode.
5. Increase V_{ac} step by step (0.1 V for each step). Measure the V_{ac} value when V_{OUT} goes above 200 V.

Test criteria:

- V_{ac} should be below 85 V_{ac} (refer to Ch1 of Figure 6)

Test 8: Brown-Out

Test conditions:

6. SW1 and SW 3 close. SW2 open (output load is around 0.13 A)
7. AC input: 85 Vac, 60 Hz
8. Use 15 V dc source applied to TB3 to enable the operation.
9. Measure V_{OUT} by oscilloscope. Set the triggering level at about 200 V (falling edge), the trigger position being set at 70% of the screen. Program the scope to observe 40 ms around in single acquisition mode.
10. Decrease V_{ac} step by step (0.1 V for each step). Measure the V_{ac} value when V_{OUT} goes below 200 V.

Test criteria:

- V_{ac} should be above 60 V_{ac} (refer to Ch1 of Figure 7)

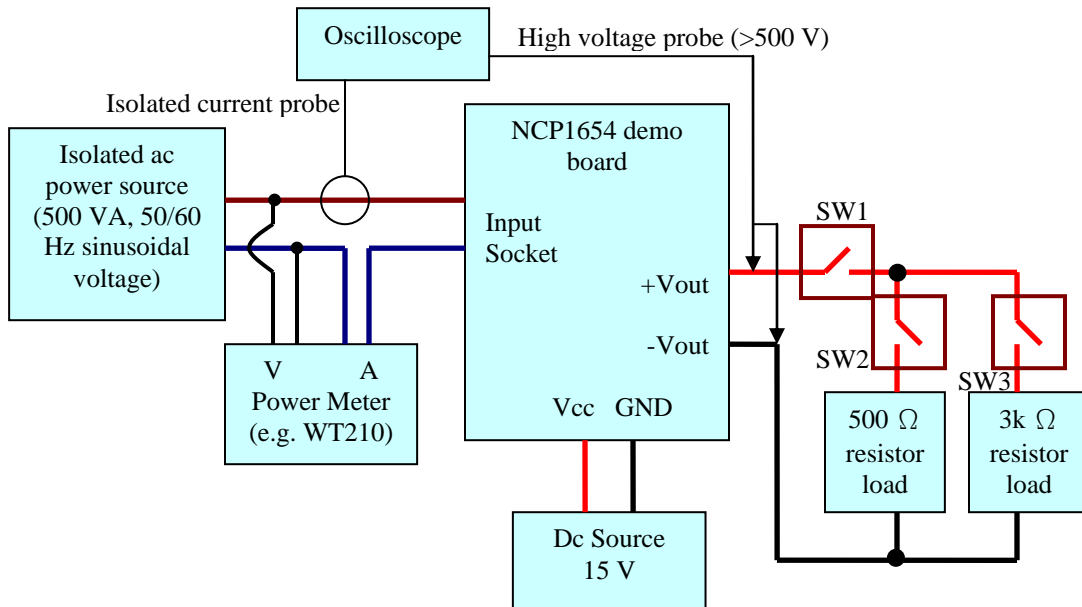

Caution: The board contains high voltage, hot, live parts. Be very cautious when manipulating or testing it. It is the responsibility of those who utilize the board, to take all the precautions to avoid that themselves or other people are injured by electric hazards or are victim of any other pains caused by the board.

Figure 1. Test Equipments Setup

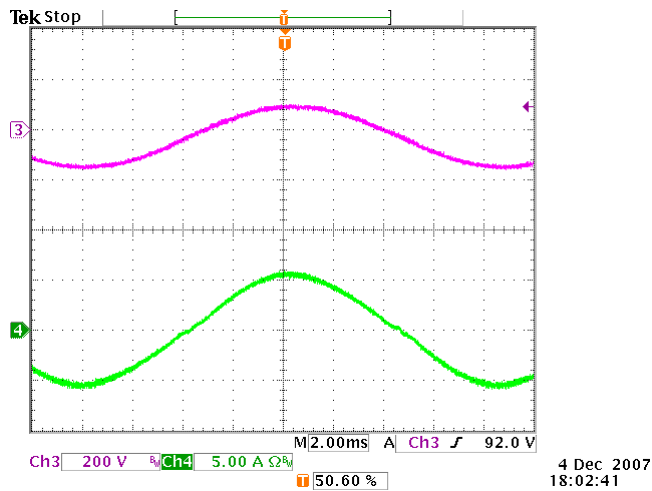

Figure 2. The input voltage (Ch3) and input current (Ch4) at low line, full load

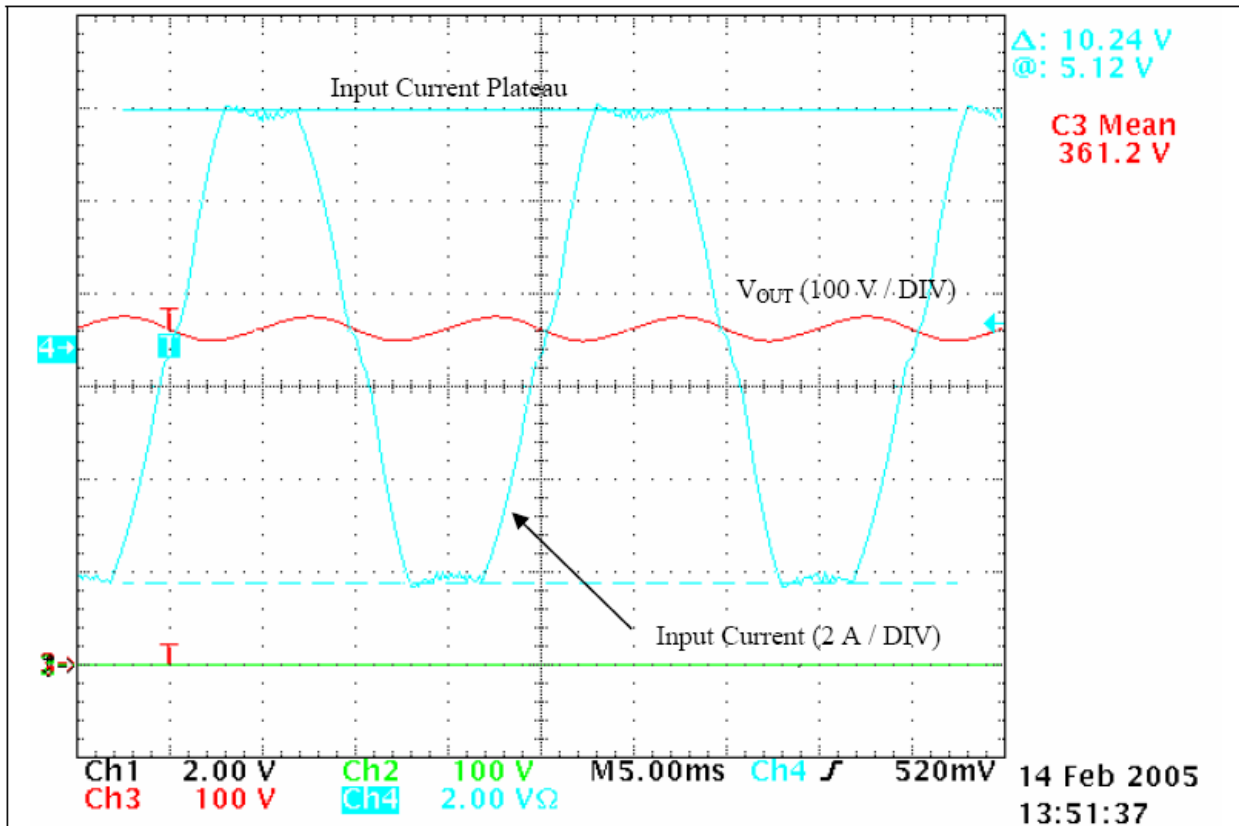

Figure 3. Over Current Limitation tested at 85 Vac input

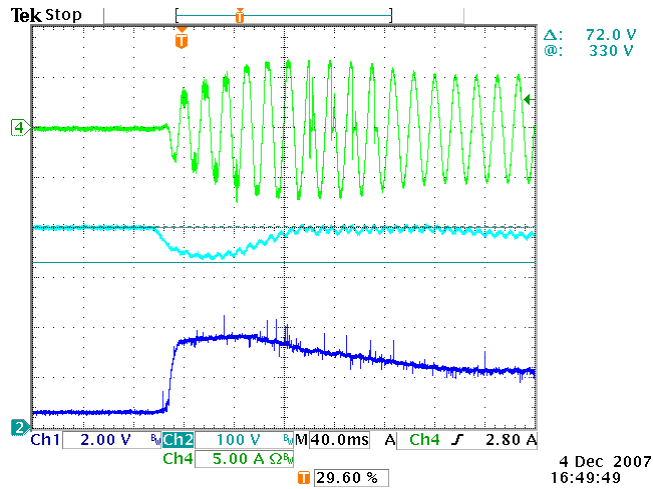

Figure 4. Fast Transient Response tested at 85 Vac input (Ch1: $V_{control}$, Ch2: V_{OUT} , Ch4: Input current)

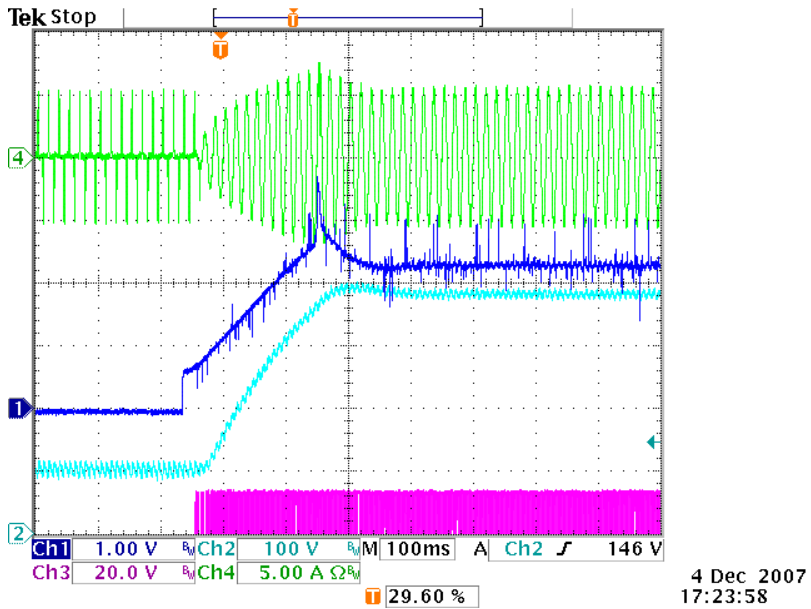

Figure 5. Start up waveform at 85 Vac input, full load. Ch1 is $V_{control}$, Ch2 is V_{OUT} , Ch3 is DRV, Ch4 is input current.

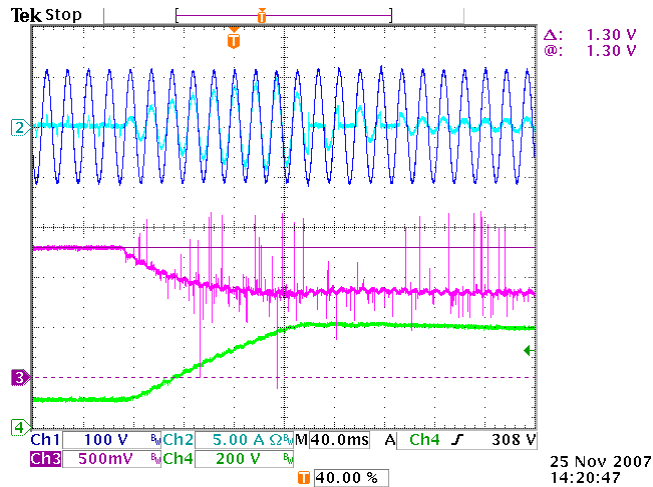

Figure 6. Brown Out Recovery Test. Increase the input from 60 Vac slowly. Observe V_{ac} when V_{OUT} rises. (Ch1: V_{ac} , Ch2: I_{in} , Ch3: V_{BO} , Ch4: V_{OUT})

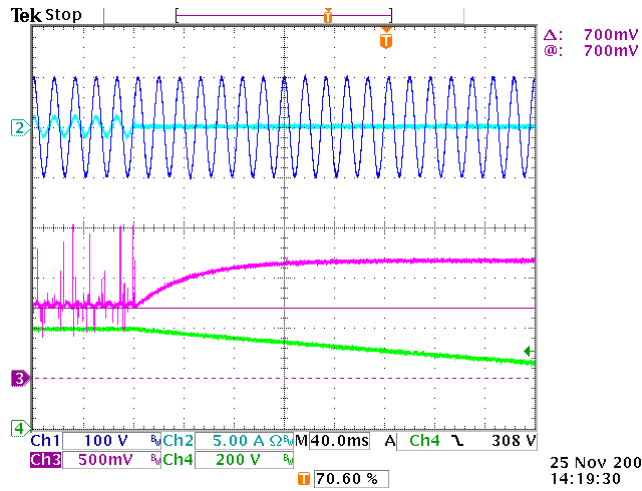

Figure 7. Brown Out Test. Decrease the input from 85 Vac slowly. Observe V_{ac} when V_{OUT} falls.
 (Ch1: V_{ac} , Ch2: I_{in} , Ch3: V_{BO} , Ch4: V_{OUT})