

MJE13005G

SWITCHMODE™ Series NPN Silicon Power Transistors

These devices are designed for high-voltage, high-speed power switching inductive circuits where fall time is critical. They are particularly suited for 115 and 220 V SWITCHMODE applications such as Switching Regulator's, Inverters, Motor Controls, Solenoid/Relay drivers and Deflection circuits.

Features

- $V_{CEO(sus)}$ 400 V
- Reverse Bias SOA with Inductive Loads @ $T_C = 100^\circ\text{C}$
- Inductive Switching Matrix 2 to 4 A, 25 and 100°C t_c @ 3A, 100°C is 180 ns (Typ)
- 700 V Blocking Capability
- SOA and Switching Applications Information
- These Devices are Pb-Free and are RoHS Compliant*

MAXIMUM RATINGS

Rating	Symbol	Value	Unit
Collector-Emitter Voltage	$V_{CEO(sus)}$	400	Vdc
Collector-Emitter Voltage	V_{CEV}	700	Vdc
Emitter-Base Voltage	V_{EBO}	9	Vdc
Collector Current – Continuous – Peak (Note 1)	I_C I_{CM}	4 8	Adc
Base Current – Continuous – Peak (Note 1)	I_B I_{BM}	2 4	Adc
Emitter Current – Continuous – Peak (Note 1)	I_E I_{EM}	6 12	Adc
Total Device Dissipation @ $T_A = 25^\circ\text{C}$ Derate above 25°C	P_D	2 0.016	W W/ $^\circ\text{C}$
Total Device Dissipation @ $T_C = 25^\circ\text{C}$ Derate above 25°C	P_D	75 0.6	W W/ $^\circ\text{C}$
Operating and Storage Junction Temperature Range	T_J, T_{stg}	-65 to +150	$^\circ\text{C}$

THERMAL CHARACTERISTICS

Characteristics	Symbol	Max	Unit
Thermal Resistance, Junction-to-Ambient	$R_{\theta JA}$	62.5	$^\circ\text{C}/\text{W}$
Thermal Resistance, Junction-to-Case	$R_{\theta JC}$	1.67	$^\circ\text{C}/\text{W}$
Maximum Lead Temperature for Soldering Purposes 1/8" from Case for 5 Seconds	T_L	275	$^\circ\text{C}$

Stresses exceeding Maximum Ratings may damage the device. Maximum Ratings are stress ratings only. Functional operation above the Recommended Operating Conditions is not implied. Extended exposure to stresses above the Recommended Operating Conditions may affect device reliability.

1. Pulse Test: Pulse Width = 5 ms, Duty Cycle $\leq 10\%$.

*For additional information on our Pb-Free strategy and soldering details, please download the ON Semiconductor Soldering and Mounting Techniques Reference Manual, SOLDERRM/D.



ON Semiconductor®

<http://onsemi.com>

**4 AMPERE
NPN SILICON
POWER TRANSISTOR
400 VOLTS – 75 WATTS**

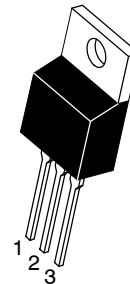

TO-220AB
CASE 221A-09
STYLE 1

MARKING DIAGRAM

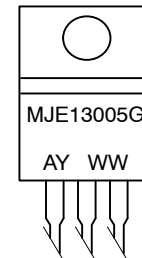

A = Assembly Location
Y = Year
WW = Work Week
G = Pb-Free Package

ORDERING INFORMATION

Device	Package	Shipping
MJE13005G	TO-220 (Pb-Free)	50 Units / Rail

MJE13005G

ELECTRICAL CHARACTERISTICS ($T_C = 25^\circ\text{C}$ unless otherwise noted)

Characteristic	Symbol	Min	Typ	Max	Unit
OFF CHARACTERISTICS (Note 2)					
Collector–Emitter Sustaining Voltage ($I_C = 10\text{ mA}$, $I_B = 0$)	$V_{CEO(sus)}$	400	–	–	Vdc
Collector Cutoff Current ($V_{CEV} = \text{Rated Value}$, $V_{BE(off)} = 1.5\text{ Vdc}$) ($V_{CEV} = \text{Rated Value}$, $V_{BE(off)} = 1.5\text{ Vdc}$, $T_C = 100^\circ\text{C}$)	I_{CEV}	–	–	1 5	mAdc
Emitter Cutoff Current ($V_{EB} = 9\text{ Vdc}$, $I_C = 0$)	I_{EBO}	–	–	1	mAdc

SECOND BREAKDOWN

Second Breakdown Collector Current with base forward biased	$I_{S/b}$	–	See Figure 11		
Clamped Inductive SOA with Base Reverse Biased	RBSOA	–	See Figure 12		

ON CHARACTERISTICS

 (Note 2)

DC Current Gain ($I_C = 1\text{ Adc}$, $V_{CE} = 5\text{ Vdc}$) ($I_C = 2\text{ Adc}$, $V_{CE} = 5\text{ Vdc}$)	h_{FE}	10 8	– –	60 40	–
Collector–Emitter Saturation Voltage ($I_C = 1\text{ Adc}$, $I_B = 0.2\text{ Adc}$) ($I_C = 2\text{ Adc}$, $I_B = 0.5\text{ Adc}$) ($I_C = 4\text{ Adc}$, $I_B = 1\text{ Adc}$) ($I_C = 2\text{ Adc}$, $I_B = 0.5\text{ Adc}$, $T_C = 100^\circ\text{C}$)	$V_{CE(sat)}$	– – – –	– – – –	0.5 0.6 1 1	Vdc
Base–Emitter Saturation Voltage ($I_C = 1\text{ Adc}$, $I_B = 0.2\text{ Adc}$) ($I_C = 2\text{ Adc}$, $I_B = 0.5\text{ Adc}$) ($I_C = 2\text{ Adc}$, $I_B = 0.5\text{ Adc}$, $T_C = 100^\circ\text{C}$)	$V_{BE(sat)}$	– – –	– – –	1.2 1.6 1.5	Vdc

DYNAMIC CHARACTERISTICS

Current–Gain – Bandwidth Product ($I_C = 500\text{ mAdc}$, $V_{CE} = 10\text{ Vdc}$, $f = 1\text{ MHz}$)	f_T	4	–	–	MHz
Output Capacitance ($V_{CB} = 10\text{ Vdc}$, $I_E = 0$, $f = 0.1\text{ MHz}$)	C_{ob}	–	65	–	pF

SWITCHING CHARACTERISTICS

Resistive Load (Table 2)						
Delay Time	$(V_{CC} = 125\text{ Vdc}$, $I_C = 2\text{ A}$, $I_{B1} = I_{B2} = 0.4\text{ A}$, $t_p = 25\text{ }\mu\text{s}$, Duty Cycle $\leq 1\%$)	t_d	–	0.025	0.1	μs
Rise Time		t_r	–	0.3	0.7	μs
Storage Time		t_s	–	1.7	4	μs
Fall Time		t_f	–	0.4	0.9	μs
Inductive Load, Clamped (Table 2, Figure 13)						
Voltage Storage Time	$(I_C = 2\text{ A}$, $V_{clamp} = 300\text{ Vdc}$, $I_{B1} = 0.4\text{ A}$, $V_{BE(off)} = 5\text{ Vdc}$, $T_C = 100^\circ\text{C}$)	t_{sv}	–	0.9	4	μs
Crossover Time		t_c	–	0.32	0.9	μs
Fall Time		t_{fi}	–	0.16	–	μs

2. Pulse Test: Pulse Width = 300 μs , Duty Cycle = 2%.

MJE13005G

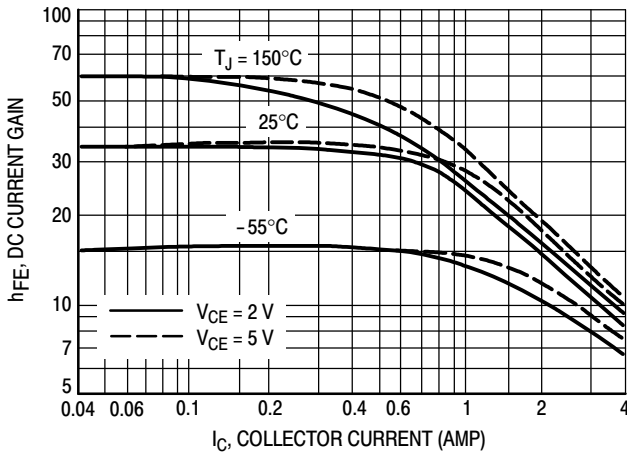

Figure 1. DC Current Gain

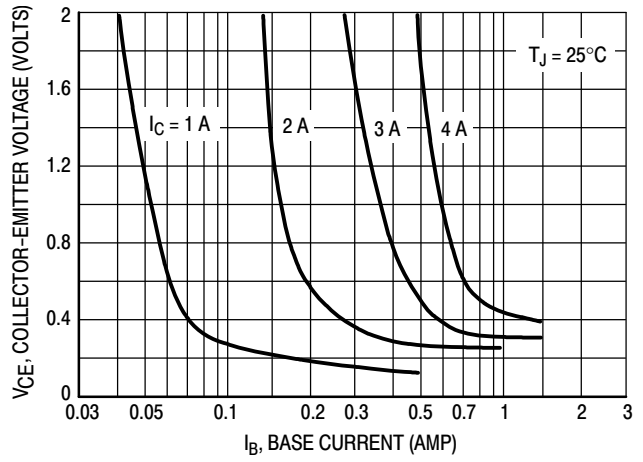

Figure 2. Collector Saturation Region

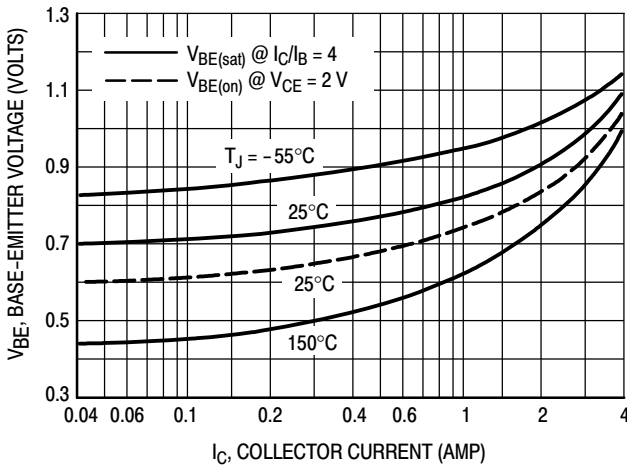

Figure 3. Base-Emitter Voltage

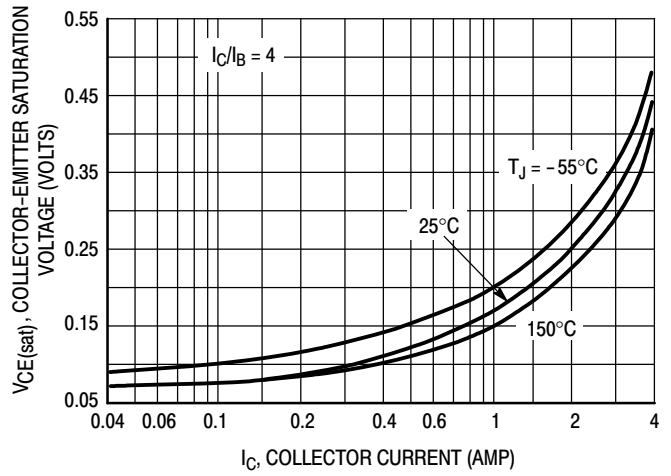

Figure 4. Collector-Emitter Saturation Voltage

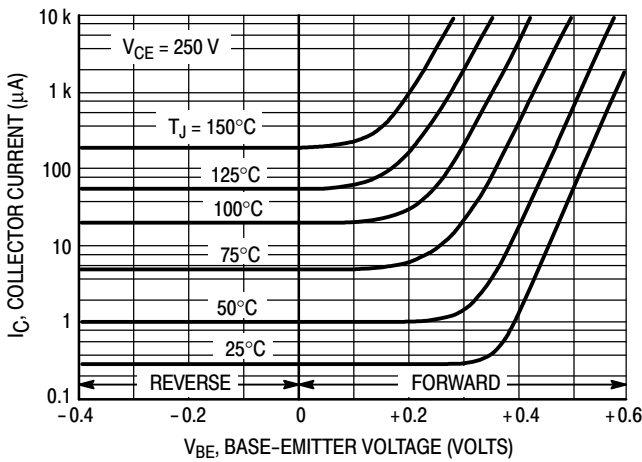

Figure 5. Collector Cutoff Region

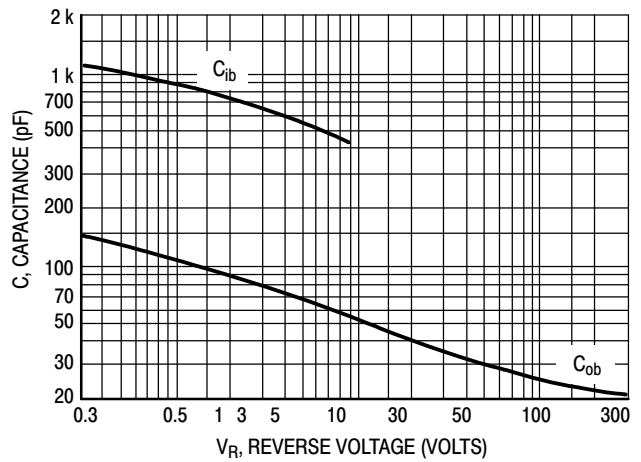

Figure 6. Capacitance

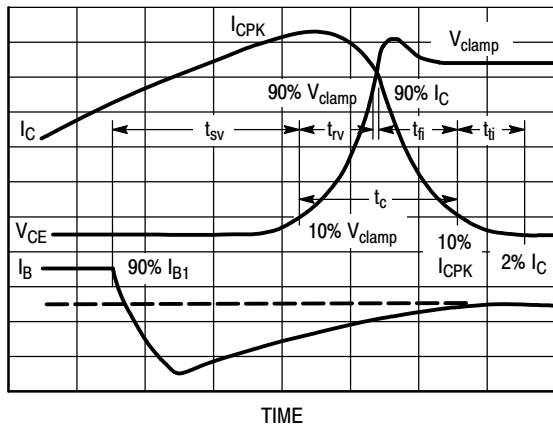

Figure 7. Inductive Switching Measurements

Table 1. Typical Inductive Switching Performance

IC AMP	TC °C	tsv ns	trv ns	tci ns	tti ns	tci ns
2	25	600	70	100	80	180
	100	900	110	240	130	320
3	25	650	60	140	60	200
	100	950	100	330	100	350
4	25	550	70	160	100	220
	100	850	110	350	160	390

NOTE: All Data recorded in the inductive Switching Circuit In Table 2.

SWITCHING TIMES NOTE

In resistive switching circuits, rise, fall, and storage times have been defined and apply to both current and voltage waveforms since they are in phase. However, for inductive loads which are common to SWITCHMODE power supplies and hammer drivers, current and voltage waveforms are not in phase. Therefore, separate measurements must be made on each waveform to determine the total switching time. For this reason, the following new terms have been defined.

tsv = Voltage Storage Time, 90% IB1 to 10% Vclamp

trv = Voltage Rise Time, 10-90% Vclamp

tci = Current Fall Time, 90-10% IC

tti = Current Tail, 10-2% IC

tci = Crossover Time, 10% Vclamp to 10% IC

An enlarged portion of the inductive switching waveforms is shown in Figure 7 to aid in the visual identity of these terms.

For the designer, there is minimal switching loss during storage time and the predominant switching power losses occur during the crossover interval and can be obtained using the standard equation from AN-222:

$$P_{SWT} = 1/2 V_{CC} I_C (t_c) f$$

In general, trv + tci ≈ tci. However, at lower test currents this relationship may not be valid.

As is common with most switching transistors, resistive switching is specified at 25°C and has become a benchmark for designers. However, for designers of high frequency converter circuits, the user oriented specifications which make this a “SWITCHMODE” transistor are the inductive switching speeds (tci and tsv) which are guaranteed at 100°C.

RESISTIVE SWITCHING PERFORMANCE

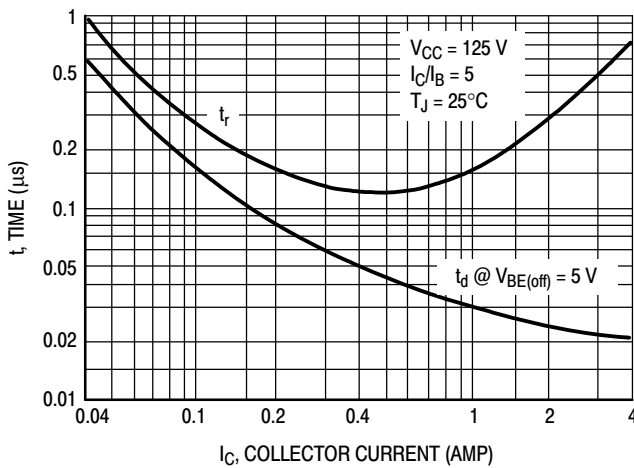

Figure 8. Turn-On Time

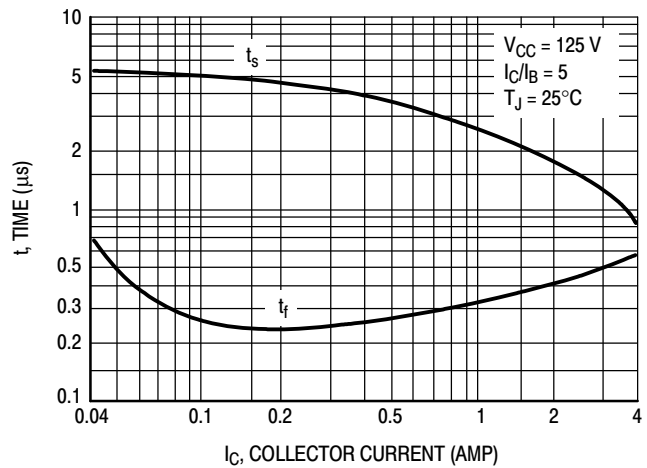

Figure 9. Turn-Off Time

MJE13005G

Table 2. Test Conditions for Dynamic Performance

REVERSE BIAS SAFE OPERATING AREA AND INDUCTIVE SWITCHING		RESISTIVE SWITCHING
TEST CIRCUITS	<p>DUTY CYCLE $\leq 10\%$ $t_r, t_f \leq 10$ ns</p> <p>NOTE PW and V_{CC} Adjusted for Desired I_C R_B Adjusted for Desired I_{B1}</p>	
CIRCUIT VALUES	<p>Coil Data: Ferroxcube Core #6656 Full Bobbin (~16 Turns) #16</p> <p>GAP for 200 μH/20 A $L_{coil} = 200 \mu$H</p> <p>$V_{CC} = 20$ V $V_{clamp} = 300$ Vdc</p>	<p>$V_{CC} = 125$ V $R_C = 62 \Omega$ D1 = 1N5820 or Equiv. $R_B = 22 \Omega$</p>
TEST WAVEFORMS	<p>OUTPUT WAVEFORMS</p> <p>t_1 ADJUSTED TO OBTAIN I_C $t_1 \approx \frac{L_{coil} (I_{C(pk)})}{V_{CC}}$</p> <p>$t_2 \approx \frac{L_{coil} (I_{C(pk)})}{V_{clamp}}$</p> <p>Test Equipment Scope-Tektronics 475 or Equivalent</p>	<p>$t_r, t_f < 10$ ns Duty Cycle = 1.0% R_B and R_C adjusted for desired I_B and I_C</p>

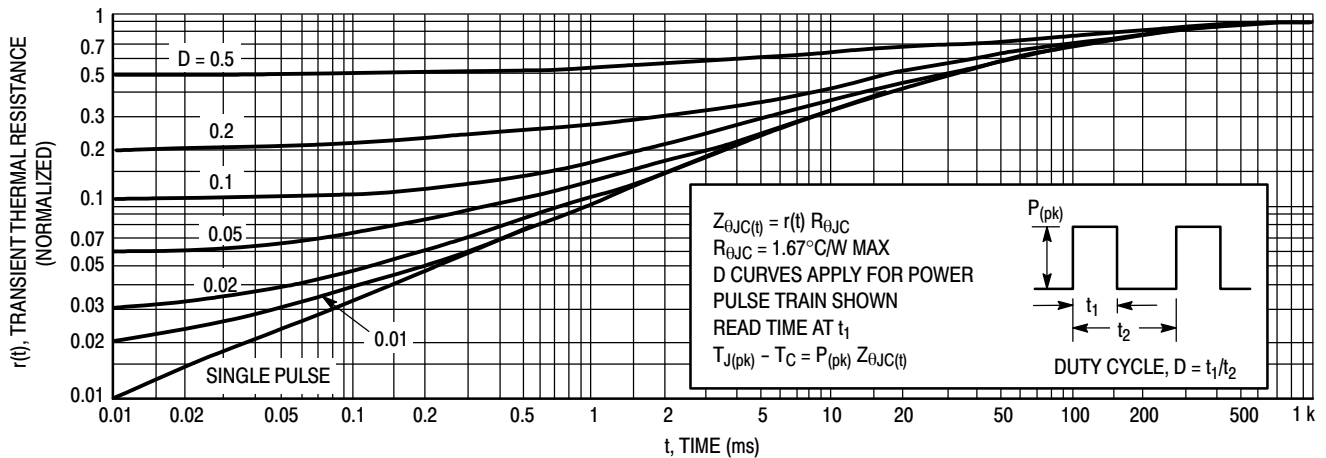

Figure 10. Typical Thermal Response [$Z_{\theta JC}(t)$]

SAFE OPERATING AREA INFORMATION

The Safe Operating Area Figures 11 and 12 are specified ratings for these devices under the test conditions shown.

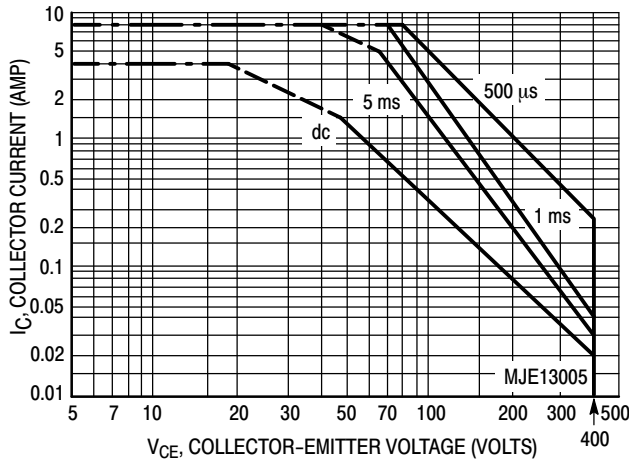

Figure 11. Forward Bias Safe Operating Area

FORWARD BIAS

There are two limitations on the power handling ability of a transistor: average junction temperature and second breakdown. Safe operating area curves indicate $I_C - V_{CE}$ limits of the transistor that must be observed for reliable operation; i.e., the transistor must not be subjected to greater dissipation than the curves indicate.

The data of Figure 11 is based on $T_C = 25^\circ\text{C}$; $T_{J(pk)}$ is variable depending on power level. Second breakdown pulse limits are valid for duty cycles to 10% but must be derated when $T_C \geq 25^\circ\text{C}$. Second breakdown limitations do not derate the same as thermal limitations. Allowable current at the voltages shown on Figure 11 may be found at any case temperature by using the appropriate curve on Figure 13.

$T_{J(pk)}$ may be calculated from the data in Figure 10. At high case temperatures, thermal limitations will reduce the power that can be handled to values less than the limitations imposed by second breakdown.

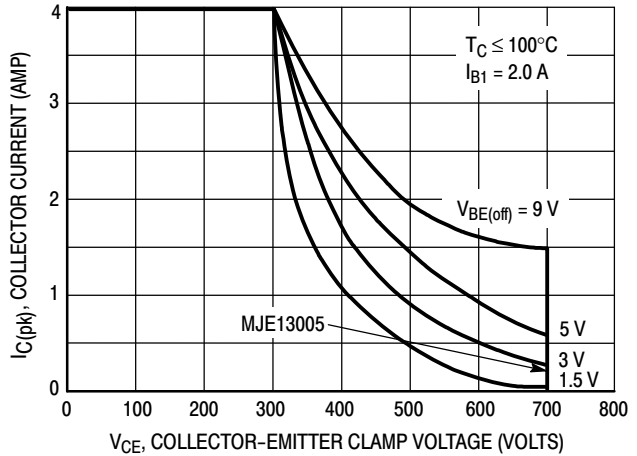

Figure 12. Reverse Bias Switching Safe Operating Area

REVERSE BIAS

For inductive loads, high voltage and high current must be sustained simultaneously during turn-off, in most cases, with the base to emitter junction reverse biased. Under these conditions the collector voltage must be held to a safe level at or below a specific value of collector current. This can be accomplished by several means such as active clamping, RC snubbing, load line shaping, etc. The safe level for these devices is specified as Reverse Bias Safe Operating Area and represents the voltage-current conditions during reverse biased turn-off. This rating is verified under clamped conditions so that the device is never subjected to an avalanche mode. Figure 12 gives the complete RBSOA characteristics.

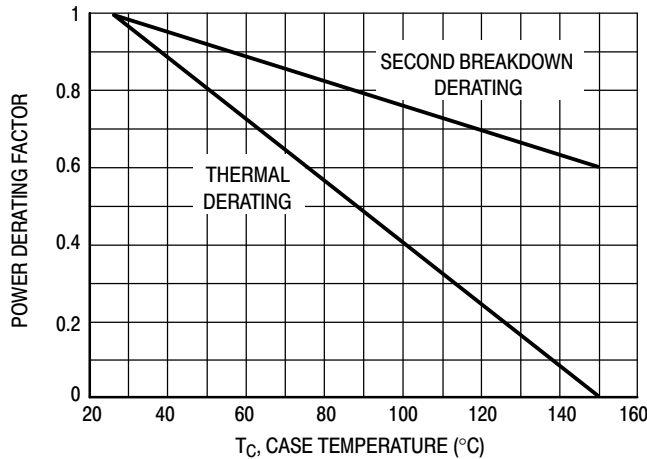

Figure 13. Forward Bias Power Derating

MECHANICAL CASE OUTLINE

PACKAGE DIMENSIONS

ON Semiconductor®



SCALE 1:1

TO-220 CASE 221A-09 ISSUE AJ

DATE 05 NOV 2019

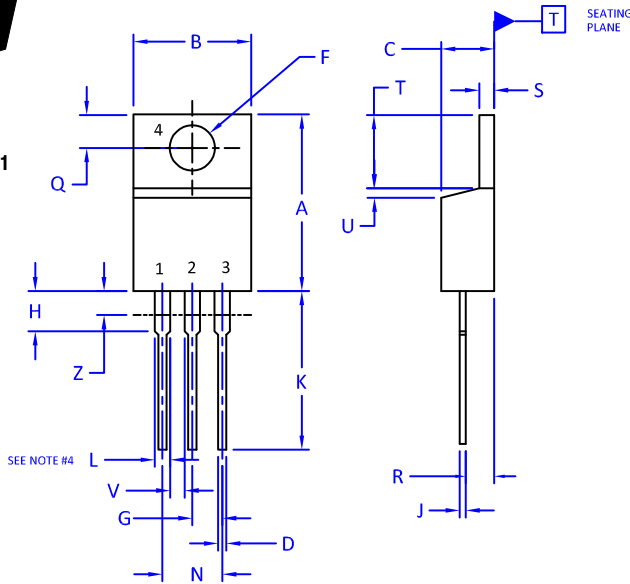

NOTES:

1. DIMENSIONING AND TOLERANCING PER ANSI Y14.5M, 2009.
2. CONTROLLING DIMENSION: INCHES
3. DIMENSION Z DEFINES A ZONE WHERE ALL BODY AND LEAD IRREGULARITIES ARE ALLOWED.
4. MAX WIDTH FOR F102 DEVICE = 1.35MM

DIM	INCHES		MILLIMETERS	
	MIN.	MAX.	MIN.	MAX.
A	0.570	0.620	14.48	15.75
B	0.380	0.415	9.66	10.53
C	0.160	0.190	4.07	4.83
D	0.025	0.038	0.64	0.96
F	0.142	0.161	3.60	4.09
G	0.095	0.105	2.42	2.66
H	0.110	0.161	2.80	4.10
J	0.014	0.024	0.36	0.61
K	0.500	0.562	12.70	14.27
L	0.045	0.060	1.15	1.52
N	0.190	0.210	4.83	5.33
Q	0.100	0.120	2.54	3.04
R	0.080	0.110	2.04	2.79
S	0.045	0.055	1.15	1.41
T	0.235	0.255	5.97	6.47
U	0.000	0.050	0.00	1.27
V	0.045	---	1.15	---
Z	---	0.080	---	2.04

STYLE 1:

- PIN 1. BASE
- 2. COLLECTOR
- 3. EMITTER
- 4. COLLECTOR

STYLE 2:

- PIN 1. BASE
- 2. EMITTER
- 3. COLLECTOR
- 4. EMITTER

STYLE 3:

- PIN 1. CATHODE
- 2. ANODE
- 3. GATE
- 4. ANODE

STYLE 4:

- PIN 1. MAIN TERMINAL 1
- 2. MAIN TERMINAL 2
- 3. GATE
- 4. MAIN TERMINAL 2

STYLE 5:

- PIN 1. GATE
- 2. DRAIN
- 3. SOURCE
- 4. DRAIN

STYLE 6:

- PIN 1. ANODE
- 2. CATHODE
- 3. ANODE
- 4. CATHODE

STYLE 7:

- PIN 1. CATHODE
- 2. ANODE
- 3. CATHODE
- 4. ANODE

STYLE 8:

- PIN 1. CATHODE
- 2. ANODE
- 3. EXTERNAL TRIP/DELAY
- 4. ANODE

STYLE 9:

- PIN 1. GATE
- 2. COLLECTOR
- 3. EMITTER
- 4. COLLECTOR

STYLE 10:

- PIN 1. GATE
- 2. SOURCE
- 3. DRAIN
- 4. SOURCE

STYLE 11:

- PIN 1. DRAIN
- 2. SOURCE
- 3. GATE
- 4. SOURCE

STYLE 12:

- PIN 1. MAIN TERMINAL 1
- 2. MAIN TERMINAL 2
- 3. GATE
- 4. NOT CONNECTED

DOCUMENT NUMBER:	98ASB42148B	Electronic versions are uncontrolled except when accessed directly from the Document Repository. Printed versions are uncontrolled except when stamped "CONTROLLED COPY" in red.
DESCRIPTION:	TO-220	PAGE 1 OF 1

ON Semiconductor and are trademarks of Semiconductor Components Industries, LLC dba ON Semiconductor or its subsidiaries in the United States and/or other countries. ON Semiconductor reserves the right to make changes without further notice to any products herein. ON Semiconductor makes no warranty, representation or guarantee regarding the suitability of its products for any particular purpose, nor does ON Semiconductor assume any liability arising out of the application or use of any product or circuit, and specifically disclaims any and all liability, including without limitation special, consequential or incidental damages. ON Semiconductor does not convey any license under its patent rights nor the rights of others.

ON Semiconductor and  are trademarks of Semiconductor Components Industries, LLC dba ON Semiconductor or its subsidiaries in the United States and/or other countries. ON Semiconductor owns the rights to a number of patents, trademarks, copyrights, trade secrets, and other intellectual property. A listing of ON Semiconductor's product/patent coverage may be accessed at www.onsemi.com/site/pdf/Patent-Marking.pdf. ON Semiconductor reserves the right to make changes without further notice to any products herein. ON Semiconductor makes no warranty, representation or guarantee regarding the suitability of its products for any particular purpose, nor does ON Semiconductor assume any liability arising out of the application or use of any product or circuit, and specifically disclaims any and all liability, including without limitation special, consequential or incidental damages. Buyer is responsible for its products and applications using ON Semiconductor products, including compliance with all laws, regulations and safety requirements or standards, regardless of any support or applications information provided by ON Semiconductor. "Typical" parameters which may be provided in ON Semiconductor data sheets and/or specifications can and do vary in different applications and actual performance may vary over time. All operating parameters, including "Typicals" must be validated for each customer application by customer's technical experts. ON Semiconductor does not convey any license under its patent rights nor the rights of others. ON Semiconductor products are not designed, intended, or authorized for use as a critical component in life support systems or any FDA Class 3 medical devices or medical devices with a same or similar classification in a foreign jurisdiction or any devices intended for implantation in the human body. Should Buyer purchase or use ON Semiconductor products for any such unintended or unauthorized application, Buyer shall indemnify and hold ON Semiconductor and its officers, employees, subsidiaries, affiliates, and distributors harmless against all claims, costs, damages, and expenses, and reasonable attorney fees arising out of, directly or indirectly, any claim of personal injury or death associated with such unintended or unauthorized use, even if such claim alleges that ON Semiconductor was negligent regarding the design or manufacture of the part. ON Semiconductor is an Equal Opportunity/Affirmative Action Employer. This literature is subject to all applicable copyright laws and is not for resale in any manner.

PUBLICATION ORDERING INFORMATION

LITERATURE FULFILLMENT:

Email Requests to: orderlit@onsemi.com

ON Semiconductor Website: www.onsemi.com

TECHNICAL SUPPORT

North American Technical Support:
Voice Mail: 1 800-282-9855 Toll Free USA/Canada
Phone: 011 421 33 790 2910

Europe, Middle East and Africa Technical Support:

Phone: 00421 33 790 2910

For additional information, please contact your local Sales Representative