

# Bi-CMOS IC Multi Voltage Regulator IC for Car Audio Systems

## LV5683P

### Overview

The LV5683P is a multi voltage regulator suitable for USB silicon tuner car-audio systems.

This IC has 4 outputs,  $V_{DD}$  5 V (3.3 V), AUDIO (8.5 V), SWU (3.3 V) and USB 5 V (CD 8 V: available).

About protection circuits, it has Over-current-protection, Over-voltage-protection and Thermal-shut-down.

$V_{CC1}$  (SWU and USB supply) is independent terminal from  $V_{CC}$ , and accepts lower voltage (ex. From DC/DC converter) which enables to reduce power dissipation.

### Features

- 4 System Regulator  
 $V_{DD}$  (LCD Micon):  $V_{OUT}$  5.0 V (3.3 V),  $I_O$  Max 300 mA, Reverse Current Prevention  
 Audio:  $V_{OUT}$  8.5 V,  $I_O$  Max 400 mA  
 SWU (Systems):  $V_{OUT}$  3.3 V,  $I_O$  Max 500 mA  
 USB:  $V_{OUT}$  5.0 V (8.0 V Available for CD),  $I_O$  Max 1100 mA
- Over-Current-Protection
- Thermal-Shut-Down Typ 175°C
- Over-Voltage-Protection: Typ 21 V (Except  $V_{DD}$ )
- Applied Pch-LDMOS for Output Stages
- This is a Pb-Free Device

**WARNING:** The protector functions only improve the IC's tolerance and they do not guarantee the safety of the IC if used under the conditions out of safety range or ratings. Use of the IC such as use under overcurrent protection range or thermal shut down state may degrade the IC's reliability and eventually damage the IC.



ON Semiconductor®

[www.onsemi.com](http://www.onsemi.com)

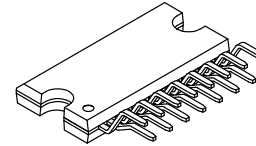

HZIP15  
CASE 945AB

### MARKING DIAGRAM

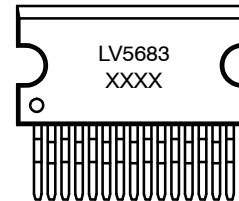

LV5683 = Specific Device Code  
XXXX = Lot No.

### ORDERING INFORMATION

Device	Package	Shipping
LV5683P-E	HZIP15 (Pb-Free)	720 / Tube

**SPECIFICATIONS**

**ABSOLUTE MAXIMUM RATINGS** (at Ta = 25°C)

Symbols	Parameter	Conditions	Ratings	Unit
V <sub>CC</sub> max	Supply voltage		36	V
Pd max (*Ta ≤ 25°C)	Allowable Power dissipation	IC unit	1.3	W
		With Al heatsink (50 x 50 x 1.5 mm <sup>3</sup> )	5.3	W
		Infinite heat radiation	26	W
V <sub>CC</sub> peak	Peak supply voltage	See below pulse wave	50	V
Topr	Operating ambient temperature		-40 to +85	°C
Tstg	Storage temperature		-55 to +150	°C
Tj max	Junction temperature		150	°C

Stresses exceeding those listed in the Maximum Ratings table may damage the device. If any of these limits are exceeded, device functionality should not be assumed, damage may occur and reliability may be affected.

**Peak Voltage Testing Pulse Wave**

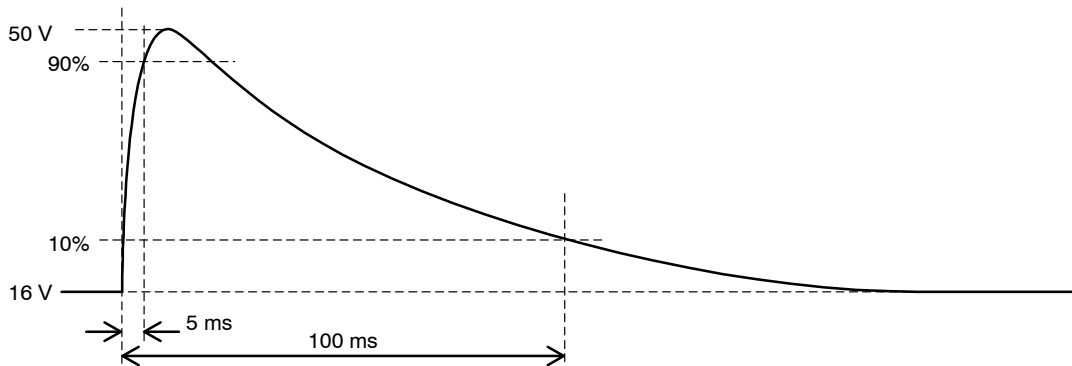

**Figure 1. Peak Voltage Testing Pulse Wave**

**RECOMMENDED OPERATING CONDITIONS** (at Ta = 25°C)

Parameter	Conditions	Ratings	Unit
Power supply voltage rating 1	V <sub>DD</sub> output (5 V / 3.3 V)	7 to 16	V
Power supply voltage rating 2	USB (5 V) output, SWU output: V <sub>CC</sub> = V <sub>CC1</sub>	7.5 to 16	V
Power supply voltage rating 3	AUDIO output	10 to 16	V
Power supply voltage rating 4	USB (8 V) output: V <sub>CC</sub> = V <sub>CC1</sub>	10.5 to 16	V

Functional operation above the stresses listed in the Recommended Operating Ranges is not implied. Extended exposure to stresses beyond the Recommended Operating Ranges limits may affect device reliability.

**ELECTRICAL CHARACTERISTICS** (at Ta = 25°C, V<sub>CC</sub> = V<sub>CC1</sub> = 14.4 V (Note 1))

Symbol	Parameter	Conditions	Min	Typ	Max	Unit
I <sub>CC</sub>	Quiescent current	V <sub>DD</sub> no load, ALL EN terminal = [L]	-	50	100	μA

**AUDIO\_EN INPUT**

Symbol	Parameter	Conditions	Min	Typ	Max	Unit
V <sub>IL1</sub>	Low input voltage		0	-	0.5	V
V <sub>IH1</sub>	High input voltage		2.8	-	5.5	V
R <sub>IN1</sub>	Input impedance		280	400	520	kΩ

**SWU\_EN INPUT**

Symbol	Parameter	Conditions	Min	Typ	Max	Unit
V <sub>IL2</sub>	Low input voltage		0	-	0.5	V

# LV5683P

## ELECTRICAL CHARACTERISTICS (at Ta = 25°C, V<sub>CC</sub> = V<sub>CC1</sub> = 14.4 V (Note 1)) (continued)

Symbol	Parameter	Conditions	Min	Typ	Max	Unit
--------	-----------	------------	-----	-----	-----	------

### SWU\_EN INPUT

V <sub>IH2</sub>	High input voltage		2.8	–	5.5	V
R <sub>IN2</sub>	Input impedance		280	400	520	kΩ

### USB\_EN INPUT

V <sub>IL3</sub>	Low input voltage		0	–	0.5	V
V <sub>IH3</sub>	High input voltage		2.8	–	5.5	V
R <sub>IN3</sub>	Input impedance		280	400	520	kΩ

### V<sub>DD</sub> (5 V / 3.3 V) OUTPUT (REVERSE CURRENT PREVENTION DIODE IMPLEMENTED)

V <sub>O11</sub>	V <sub>DD</sub> output voltage 1	I <sub>O11</sub> = 200 mA, I <sub>KV<sub>DD</sub></sub> = OPEN, or V <sub>DDout</sub>	4.75	5.0	5.25	V
I <sub>O11</sub>	V <sub>DD</sub> output current 1	V <sub>O11</sub> ≥ 4.7 V	300	–	–	mA
V <sub>O12</sub>	V <sub>DD</sub> output voltage 2	I <sub>O12</sub> = 200 mA, I <sub>KV<sub>DD</sub></sub> = GND	3.13	3.3	3.47	V
I <sub>O12</sub>	V <sub>DD</sub> output current 2	V <sub>O12</sub> ≥ 3.1 V	300	–	–	mA
ΔV <sub>OLN1</sub>	Line regulation	7 V < V <sub>CC</sub> < 16 V, I <sub>O1</sub> = 200 mA	–	50	100	mV
ΔV <sub>OLD1</sub>	Load regulation	1 mA < I <sub>O11</sub> , I <sub>O12</sub> < 200 mA	–	80	150	mV
V <sub>DROP1</sub>	Dropout voltage 1	I <sub>O1</sub> = 200 mA (implemented diode)	–	1.5	2.5	V
R <sub>REJ1</sub>	V <sub>CC</sub> ripple rejection	f = 120 Hz, V <sub>CC</sub> = 1 V <sub>PP</sub> , I <sub>O1</sub> = 200 mA	40 (Note 2)	50 (Note 2)	–	dB
I <sub>REV</sub>	V <sub>DD</sub> reverse current	V <sub>O11</sub> = 5.0 V, V <sub>CC</sub> = 0 V	–	10	100	μA

### USB / CD OUTPUT; USB\_EN = HIGH

V <sub>O21</sub>	USB output voltage 1	I <sub>O21</sub> = 1000 mA, I <sub>KUSB</sub> = OPEN, or USBout	7.6	8.0	8.4	V
I <sub>O21</sub>	USB output current 1	V <sub>O21</sub> ≥ 7.45 V	1100	–	–	mA
V <sub>O22</sub>	USB output voltage 2	I <sub>O22</sub> = 1000 mA, I <sub>KUSB</sub> = GND	4.75	5.0	5.25	V
I <sub>O22</sub>	USB output current 2	V <sub>O22</sub> ≥ 4.6 V	1100	–	–	mA
ΔV <sub>OLN2</sub>	Line regulation	10.5 V < V <sub>CC1</sub> < 16 V, I <sub>O2</sub> = 1000 mA	–	50	100	mV
ΔV <sub>OLD2</sub>	Load regulation	10 mA < I <sub>O21</sub> , I <sub>O22</sub> < 1000 mA	–	100	200	mV
V <sub>DROP2</sub>	Dropout voltage	I <sub>O21</sub> , I <sub>O22</sub> = 1000 mA	–	1.0	2.0	V
R <sub>REJ2</sub>	V <sub>CC1</sub> ripple rejection	f = 120 Hz, V <sub>CC1</sub> = 1V <sub>PP</sub> , I <sub>O2</sub> = 1000 mA	40 (Note 2)	50 (Note 2)	–	dB

### AUDIO OUTPUT; AUDIO\_EN = HIGH

V <sub>O3</sub>	AUDIO output voltage	I <sub>O3</sub> = 300 mA	8.1	8.5	8.9	V
I <sub>O3</sub>	AUDIO output current	V <sub>O3</sub> ≥ 8 V	400	–	–	mA
ΔV <sub>OLN3</sub>	Line regulation	10 V < V <sub>CC</sub> < 16 V, I <sub>O3</sub> = 300 mA	–	30	100	mV
ΔV <sub>OLD3</sub>	Load regulation	1 mA < I <sub>O3</sub> < 300 mA	–	70	140	mV
V <sub>DROP3</sub>	Dropout voltage	I <sub>O3</sub> = 300 mA	–	0.6	1.05	V
R <sub>REJ3</sub>	V <sub>CC</sub> ripple rejection	f = 120 Hz, V <sub>CC</sub> = 1 V <sub>PP</sub> , I <sub>O3</sub> = 300 mA	40 (Note 2)	50 (Note 2)	–	dB

### SWU (3.3 V) OUTPUT; SEU\_EN = HIGH

V <sub>O4</sub>	SWU output voltage	I <sub>O4</sub> = 400 mA	3.13	3.3	3.47	V
I <sub>O4</sub>	SWU output current	V <sub>O4</sub> ≥ 3.1 V	500	–	–	mA
ΔV <sub>OLN4</sub>	Line regulation	7.5 V < V <sub>CC1</sub> < 16 V, I <sub>O4</sub> = 400 mA	–	30	100	mV
ΔV <sub>OLD4</sub>	Load regulation	1 mA < I <sub>O4</sub> < 400 mA	–	80	150	mV
R <sub>REJ4</sub>	V <sub>CC1</sub> ripple rejection	f = 120 Hz, V <sub>CC1</sub> = 1 V <sub>PP</sub> , I <sub>O4</sub> = 400 mA	40 (Note 2)	50 (Note 2)	–	dB

Product parametric performance is indicated in the Electrical Characteristics for the listed test conditions, unless otherwise noted. Product performance may not be indicated by the Electrical Characteristics if operated under different conditions.

- The entire specification has been defined based on the tests performed under the conditions where T<sub>j</sub> and Ta (= 25°C) are almost equal. There tests were performed with pulse load to minimize the increase of junction temperature(T<sub>j</sub>).
- Design certification

# LV5683P

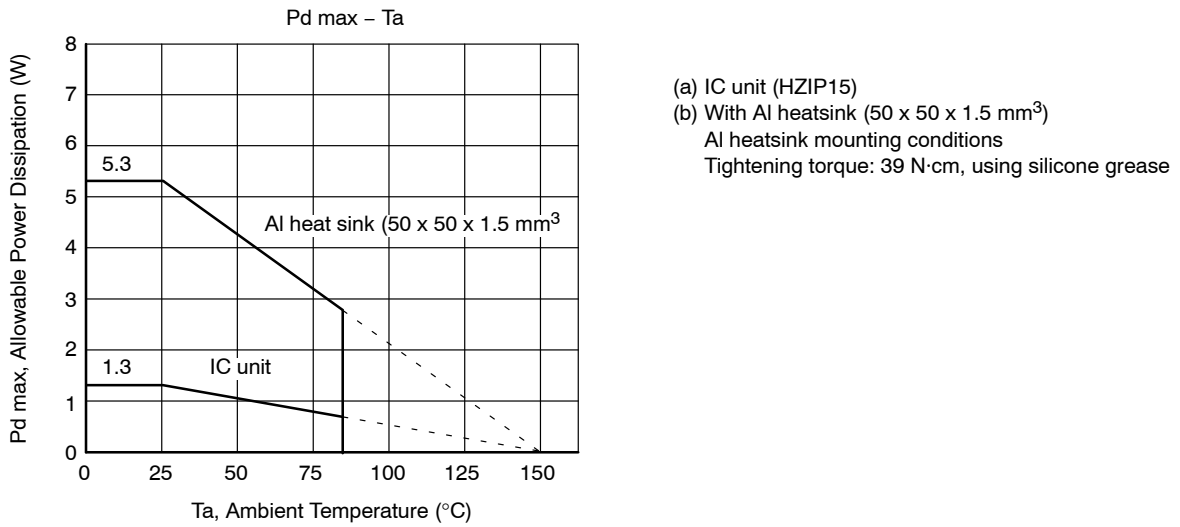

**Figure 2. Allowable Power Dissipation Derating Curve**

## PIN ASSIGNMENT

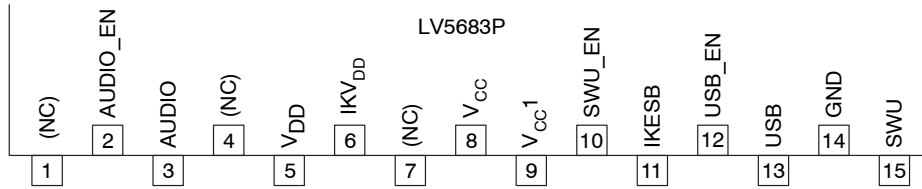

**Figure 3. Pin Assignment**

BLOCK DIAGRAM

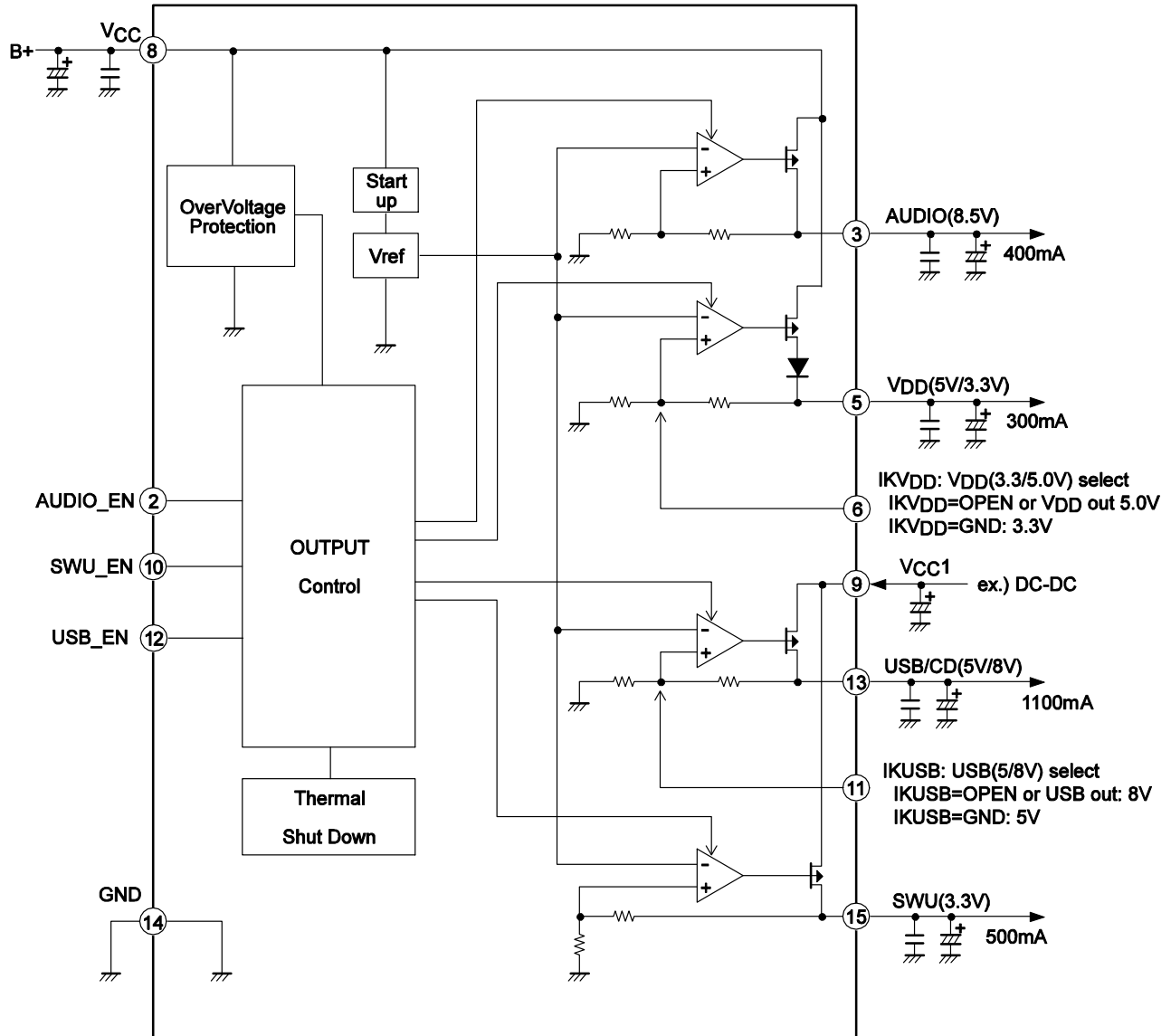

Figure 4. Block Diagram

# LV5683P

## PIN FUNCTION

Pin No.	Pin Name	Description	Description
1	N.C.	-	-
2	AUDIO_EN	AUDIO output CTRL	
3	AUDIO	AUDIO output when AUDIO_EN = High, ON 8.5 V / 0.4 A	
4	N.C.	-	-
5	V <sub>DD</sub>	V <sub>DD</sub> output 5.0 V, 3.3 V / 0.3 A	
6	IKV <sub>DD</sub>	V <sub>DD</sub> output voltage select OPEN: V <sub>DD</sub> = 5.0 V GND: V <sub>DD</sub> = 3.3 V	
7	N.C.	-	-

PIN FUNCTION (continued)

Pin No.	Pin Name	Description	Description
8	V <sub>CC</sub>	V <sub>CC</sub>	
9	V <sub>CC1</sub>	V <sub>CC1</sub>	
10	SWU_EN	SWU output CTRL	
11	IKUSB	USB output voltage select OPEN: V <sub>DD</sub> = 8.0 V GND: V <sub>DD</sub> = 5.0 V	
12	USB_EN	USB output CTRL	
13	USB	USB output when USB_EN = High, ON 5.0 V, 8.0 V / 1.1 A	

# LV5683P

## PIN FUNCTION (continued)

Pin No.	Pin Name	Description	Description
14	GND	GND	
15	SWU	SWU output when SWU_EN = High, ON 3.3 V / 0.5 A	

## Timing Chart

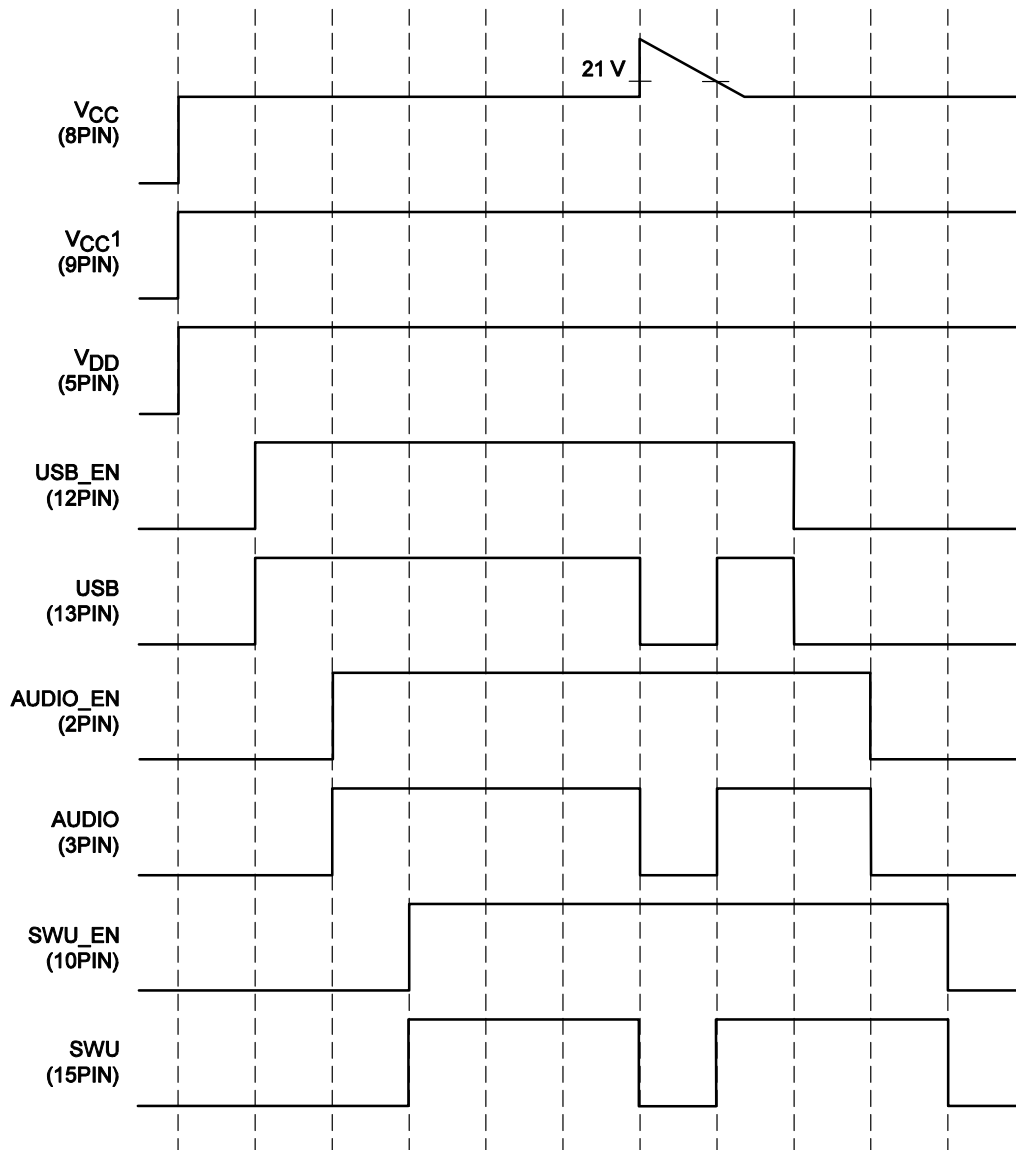

Figure 5. Timing Chart



*HZIP15 Heat Sink Attachment*

Heat sinks are used to lower the semiconductor device junction temperature by leading the heat generated by the device to the outer environment and dissipating that heat.

- a. Unless otherwise specified, for power ICs with tabs and power ICs with attached heat sinks, solder must not be applied to the heat sink or tabs.

b. Heat sink attachment

- Use flat-head screws to attach heat sinks.
  - Use also washer to protect the package.
  - Use tightening torques in the ranges 39 – 59 Ncm (4 – 6 kgcm).
  - If tapping screws are used, do not use screws with a diameter larger than the holes in the semiconductor device itself.
  - Do not make gap, dust, or other contaminants to get between the semiconductor device and the tab or heat sink.
  - Take care a position of via hole.
  - Do not allow dirt, dust, or other contaminants to get between the semiconductor device and the tab or heat sink.
  - Verify that there are no press burrs or screw-hole burrs on the heat sink.
  - Warping in heat sinks and printed circuit boards must be no more than 0.05 mm between screw holes, for either concave or convex warping.
  - Twisting must be limited to under 0.05 mm.
  - Heat sink and semiconductor device are mounted in parallel.
- Take care of electric or compressed air drivers
- The speed of these torque wrenches should never exceed 700 rpm, and should typically be about 400 rpm.

c. Silicone grease

- Spread the silicone grease evenly when mounting heat sinks.
- Our company recommends YG-6260 (Momentive Performance Materials Japan LLC)

d. Mount

- First mount the heat sink on the semiconductor device, and then mount that assembly on the printed circuit board.
- When attaching a heat sink after mounting a semiconductor device into the printed circuit board, when tightening up a heat sink with the screw, the mechanical stress which is impossible to the semiconductor device and the pin doesn't hang.

e. When mounting the semiconductor device to the heat sink using jigs, etc.,

- Take care not to allow the device to ride onto the jig or positioning dowel.
- Design the jig so that no unreasonable mechanical stress is not applied to the semiconductor device.

f. Heat sink screw holes

- Be sure that chamfering and shear drop of heat sinks must not be larger than the diameter of screw head used.
- When using nuts, do not make the heat sink hole diameters larger than the diameter of the head of the screws used. A hole diameter about 15% larger than the diameter of the screw is desirable.
- When tap screws are used, be sure that the diameter of the holes in the heat sink are not too small. A diameter about 15% smaller than the diameter of the screw is desirable.

- g. There is a method to mount the semiconductor device to the heat sink by using a spring band. But this method is not recommended because of possible displacement due to fluctuation of the spring force with time or vibration.

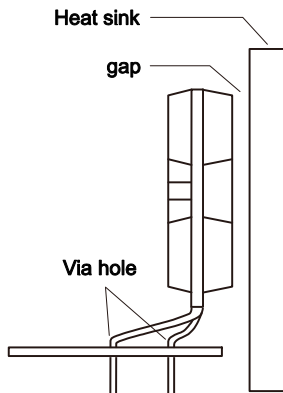
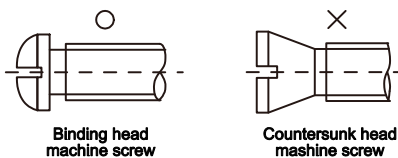
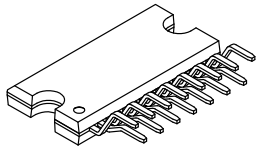

Figure 6.

# MECHANICAL CASE OUTLINE

## PACKAGE DIMENSIONS

ON Semiconductor®



**HZIP15**  
CASE 945AB  
ISSUE A

DATE 24 OCT 2013

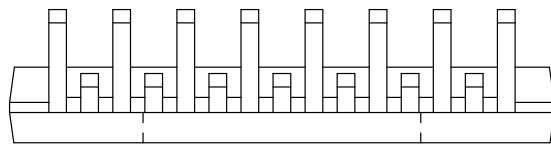
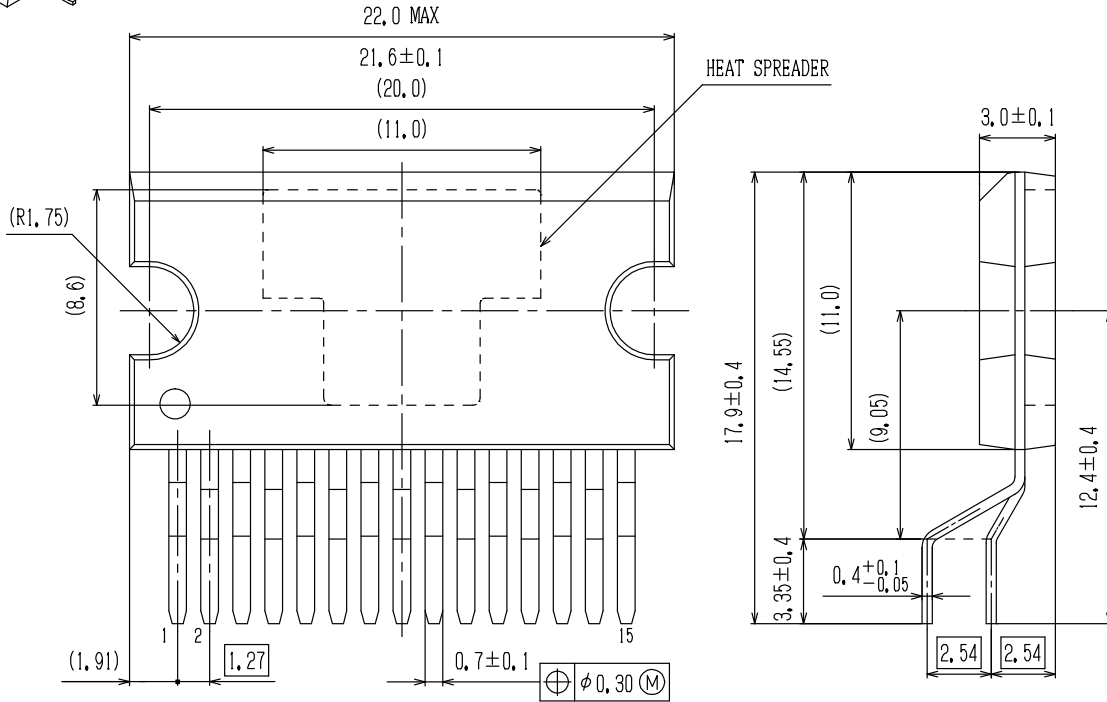

**SOLDERING FOOTPRINT\***

(Unit: mm)

○ Through Hole Area

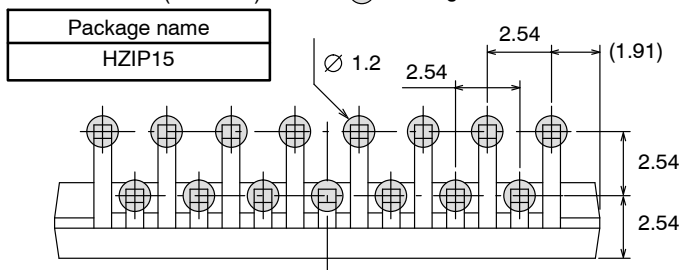

### GENERIC MARKING DIAGRAM\*

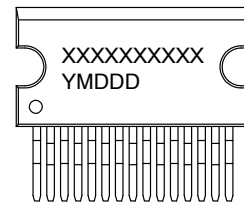

XXXXX = Specific Device Code

Y = Year

M = Month

DDD = Additional Traceability Data

\*This information is generic. Please refer to device data sheet for actual part marking. Pb-Free indicator, "G" or microdot "▪", may or may not be present.

NOTE: The measurements are not to guarantee but for reference only.

\*For additional information on our Pb-Free strategy and soldering details, please download the ON Semiconductor Soldering and Mounting Techniques Reference Manual, SOLDERRM/D.

<b>DOCUMENT NUMBER:</b>	<b>98AON65474E</b>	Electronic versions are uncontrolled except when accessed directly from the Document Repository. Printed versions are uncontrolled except when stamped "CONTROLLED COPY" in red.
<b>DESCRIPTION:</b>	<b>HZIP15</b>	<b>PAGE 1 OF 1</b>

ON Semiconductor and are trademarks of Semiconductor Components Industries, LLC dba ON Semiconductor or its subsidiaries in the United States and/or other countries. ON Semiconductor reserves the right to make changes without further notice to any products herein. ON Semiconductor makes no warranty, representation or guarantee regarding the suitability of its products for any particular purpose, nor does ON Semiconductor assume any liability arising out of the application or use of any product or circuit, and specifically disclaims any and all liability, including without limitation special, consequential or incidental damages. ON Semiconductor does not convey any license under its patent rights nor the rights of others.

ON Semiconductor and  are trademarks of Semiconductor Components Industries, LLC dba ON Semiconductor or its subsidiaries in the United States and/or other countries. ON Semiconductor owns the rights to a number of patents, trademarks, copyrights, trade secrets, and other intellectual property. A listing of ON Semiconductor's product/patent coverage may be accessed at [www.onsemi.com/site/pdf/Patent-Marking.pdf](http://www.onsemi.com/site/pdf/Patent-Marking.pdf). ON Semiconductor reserves the right to make changes without further notice to any products herein. ON Semiconductor makes no warranty, representation or guarantee regarding the suitability of its products for any particular purpose, nor does ON Semiconductor assume any liability arising out of the application or use of any product or circuit, and specifically disclaims any and all liability, including without limitation special, consequential or incidental damages. Buyer is responsible for its products and applications using ON Semiconductor products, including compliance with all laws, regulations and safety requirements or standards, regardless of any support or applications information provided by ON Semiconductor. "Typical" parameters which may be provided in ON Semiconductor data sheets and/or specifications can and do vary in different applications and actual performance may vary over time. All operating parameters, including "Typicals" must be validated for each customer application by customer's technical experts. ON Semiconductor does not convey any license under its patent rights nor the rights of others. ON Semiconductor products are not designed, intended, or authorized for use as a critical component in life support systems or any FDA Class 3 medical devices or medical devices with a same or similar classification in a foreign jurisdiction or any devices intended for implantation in the human body. Should Buyer purchase or use ON Semiconductor products for any such unintended or unauthorized application, Buyer shall indemnify and hold ON Semiconductor and its officers, employees, subsidiaries, affiliates, and distributors harmless against all claims, costs, damages, and expenses, and reasonable attorney fees arising out of, directly or indirectly, any claim of personal injury or death associated with such unintended or unauthorized use, even if such claim alleges that ON Semiconductor was negligent regarding the design or manufacture of the part. ON Semiconductor is an Equal Opportunity/Affirmative Action Employer. This literature is subject to all applicable copyright laws and is not for resale in any manner.

## PUBLICATION ORDERING INFORMATION

### LITERATURE FULFILLMENT:

Email Requests to: [orderlit@onsemi.com](mailto:orderlit@onsemi.com)

ON Semiconductor Website: [www.onsemi.com](http://www.onsemi.com)

### TECHNICAL SUPPORT

North American Technical Support:  
Voice Mail: 1 800-282-9855 Toll Free USA/Canada  
Phone: 011 421 33 790 2910

### Europe, Middle East and Africa Technical Support:

Phone: 00421 33 790 2910

For additional information, please contact your local Sales Representative