

FDMS8350LET40

MOSFET N-Channel POWERTRENCH®

40 V, 300 A, 0.85 mΩ

General Description

This N-Channel MV MOSFET is produced using ON Semiconductor's advanced POWERTRENCH process that has been especially tailored to minimize the on-state resistance and yet maintain superior switching performance.

Features

- Max $R_{DS(on)}$ = 0.85 mΩ at $V_{GS} = 10$ V, $I_D = 47$ A
- Max $R_{DS(on)}$ = 1.2 mΩ at $V_{GS} = 4.5$ V, $I_D = 38$ A
- Advanced Package and Silicon combination for Low $r_{DS(on)}$ and High Efficiency
- MSL1 Robust Package Design
- 100% UIL Tested
- These Devices are Pb-Free and are RoHS Compliant

Applications

- Primary DC-DC MOSFET
- Secondary Synchronous Rectifier
- Load Switch

MAXIMUM RATINGS ($T_A = 25^\circ\text{C}$ unless otherwise noted)

Symbol	Parameter	Value	Unit
V_{DS}	Drain to Source Voltage	40	V
V_{GS}	Gate to Source Voltage	±20	V
I_D	Drain Current:	300	A
	Continuous ($T_C = 25^\circ\text{C}$) (Note 5)	212	
	Continuous $T_C = 100^\circ\text{C}$ (Note 5)		
	Continuous, $T_A = 25^\circ\text{C}$ (Note 1a)		
	Pulsed (Note 4)	49	
		1464	
E_{AS}	Single Pulse Avalanche Energy (Note 3)	1176	mJ
P_D	Power Dissipation:	125	W
	$T_C = 25^\circ\text{C}$		
	$T_A = 25^\circ\text{C}$ (Note 1a)	3.33	
T_J, T_{STG}	Operating and Storage Junction Temperature Range	-55 to +175	°C

Stresses exceeding those listed in the Maximum Ratings table may damage the device. If any of these limits are exceeded, device functionality should not be assumed, damage may occur and reliability may be affected.



ON Semiconductor®

www.onsemi.com

V_{DS}	$R_{DS(on)}$ MAX	I_D MAX
40 V	0.85 mΩ @ 10 V	47 A
	1.2 mΩ @ 4.5 V	

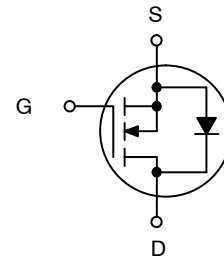

N-CHANNEL MOSFET

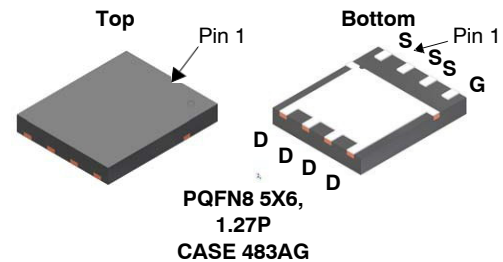

MARKING DIAGRAM



$\$Y$ = ON Semiconductor Logo
 $\&Z$ = Assembly Plant Code
 $\&3$ = Data Code (Year & Week)
 $\&K$ = Lot
 FDMS8350LET40 = Specific Device Code

ORDERING INFORMATION

See detailed ordering and shipping information on page 3 of this data sheet.

FDMS8350LET40

THERMAL CHARACTERISTICS

Symbol	Parameter	Value	Unit
$R_{\theta JC}$	Thermal Resistance, Junction to Case	1.2	°C/W
$R_{\theta JA}$	Thermal Resistance, Junction to Ambient (Note 1a)	45	

ELECTRICAL CHARACTERISTICS ($T_J = 25^\circ\text{C}$ unless otherwise noted)

Symbol	Parameter	Test Condition	Min	Typ	Max	Unit
--------	-----------	----------------	-----	-----	-----	------

OFF CHARACTERISTICS

BV_{DSS}	Drain to Source Breakdown Voltage	$I_D = 250 \mu\text{A}, V_{GS} = 0 \text{V}$	40			V
$\Delta BV_{DSS} / \Delta T_J$	Breakdown Voltage Temperature Coefficient	$I_D = 250 \mu\text{A}$, referenced to 25°C		17		mV/°C
I_{DSS}	Zero Gate Voltage Drain Current	$V_{DS} = 32 \text{V}, V_{GS} = 0 \text{V}$			1	μA
I_{GSS}	Gate to Source Leakage Current	$V_{GS} = \pm 20 \text{V}, V_{DS} = 0 \text{V}$			± 100	nA

ON CHARACTERISTICS

$V_{GS(th)}$	Gate to Source Threshold Voltage	$V_{GS} = V_{DS}, I_D = 250 \mu\text{A}$	1.0	1.8	3.0	V
$\Delta V_{GS(th)} / \Delta T_J$	Gate to Source Threshold Voltage Temperature Coefficient	$I_D = 250 \mu\text{A}$, referenced to 25°C		-6		mV/°C
$r_{DS(on)}$	Static Drain to Source On Resistance	$V_{GS} = 10 \text{V}, I_D = 47 \text{A}$		0.68	0.85	m Ω
		$V_{GS} = 4.5 \text{V}, I_D = 38 \text{A}$		0.96	1.2	
		$V_{GS} = 10 \text{V}, I_D = 47 \text{A}, T_J = 150^\circ\text{C}$		1.1	1.4	
g_{FS}	Forward Transconductance	$V_{DS} = 5 \text{V}, I_D = 47 \text{A}$		247		S

DYNAMIC CHARACTERISTICS

C_{iss}	Input Capacitance	$V_{DS} = 20 \text{V}, V_{GS} = 0 \text{V}, f = 1 \text{MHz}$		11850	16590	pF
C_{oss}	Output Capacitance			3430	4805	pF
C_{rss}	Reverse Transfer Capacitance			69	100	pF
R_g	Gate Resistance		0.1	1.2	2.4	Ω

SWITCHING CHARACTERISTICS

$t_{d(on)}$	Turn-On Delay Time	$V_{DD} = 20 \text{V}, I_D = 47 \text{A}, V_{GS} = 10 \text{V}, R_{GEN} = 6 \Omega$		32	51	ns
t_r	Rise Time			19	34	ns
$t_{d(off)}$	Turn-Off Delay Time			74	118	ns
t_f	Fall Time			15	27	ns
Q_g	Total Gate Charge	$V_{GS} = 0 \text{V to } 10 \text{V}$		156	219	nC
		$V_{GS} = 0 \text{V to } 4.5 \text{V}$		73	102	nC
Q_{gs}	Gate to Source Charge	$V_{DD} = 20 \text{V}, I_D = 47 \text{A}$		33		nC
Q_{gd}	Gate to Drain "Miller" Charge	$V_{DD} = 20 \text{V}, I_D = 47 \text{A}$		16		nC

FDMS8350LET40

ELECTRICAL CHARACTERISTICS ($T_J = 25^\circ\text{C}$ unless otherwise noted) (continued)

Symbol	Parameter	Test Condition	Min	Typ	Max	Unit
DRAIN-SOURCE DIODE CHARACTERISTICS						
V_{SD}	Source to Drain Diode Forward Voltage	$V_{GS} = 0\text{ V}, I_S = 2.1\text{ A}$ (Note 2)		0.7	1.2	V
		$V_{GS} = 0\text{ V}, I_S = 47\text{ A}$ (Note 2)		0.8	1.3	
t_{rr}	Reverse Recovery Time	$I_F = 47\text{ A}, di/dt = 100\text{ A}/\mu\text{s}$		81	129	ns
Q_{rr}	Reverse Recovery Charge			82	131	nC

Product parametric performance is indicated in the Electrical Characteristics for the listed test conditions, unless otherwise noted. Product performance may not be indicated by the Electrical Characteristics if operated under different conditions.

1. $R_{\theta JA}$ is determined with the device mounted on a 1 in² pad 2 oz copper pad on a 1.5 × 1.5 in. board of FR-4 material. $R_{\theta JC}$ is guaranteed by design while $R_{\theta CA}$ is determined by the user's board design.

NOTES:

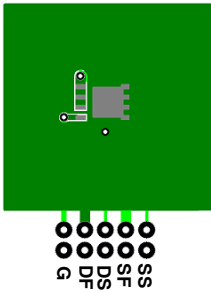

a) $45^\circ\text{C}/\text{W}$ when mounted on a 1 in² pad of 2 oz copper.

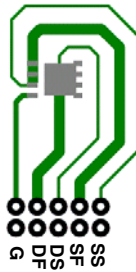

b) $115^\circ\text{C}/\text{W}$ when mounted on a minimum pad of 2 oz copper.

- Pulse Test: Pulse Width < 300 μs , Duty cycle < 2.0%.
- E_{AS} of 1176 mJ is based on starting $T_J = 25^\circ\text{C}$; $L = 3\text{ mH}$, $I_{AS} = 28\text{ A}$, $V_{DD} = 40\text{ V}$, $V_{GS} = 10\text{ V}$. 100% test at $L = 0.1\text{ mH}$, $I_{AS} = 87\text{ A}$.
- Pulsed I_d please refer to Fig 11 SOA graph for more details.
- Computed continuous current limited to Max Junction Temperature only, actual continuous current will be limited by thermal & electro-mechanical application board design.

ORDERING INFORMATION

Device	Marking	Package	Reel Size	Tape Width	Quantity
FDMS8350LET40	FDMS8350LET	Power 56	13"	12 mm	3000 units

TYPICAL CHARACTERISTICS

($T_J = 25^\circ\text{C}$ unless otherwise noted)

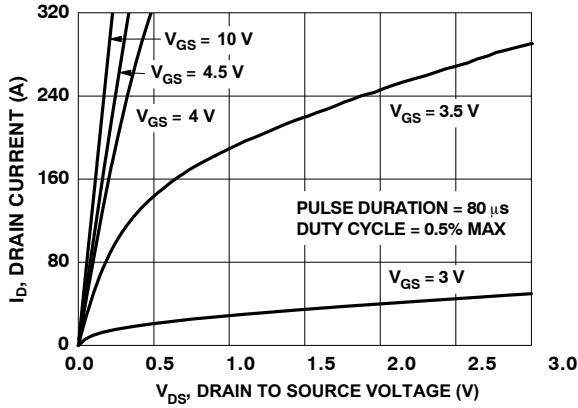

Figure 1. On-Region Characteristics

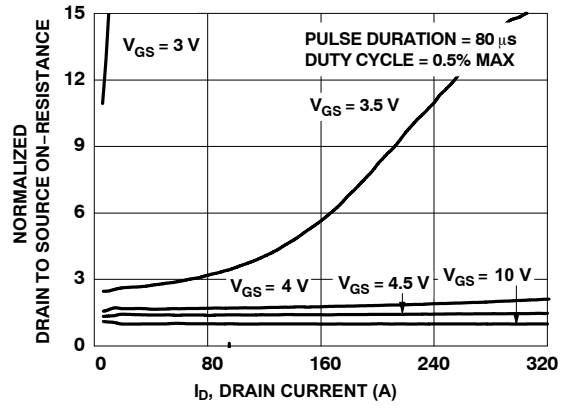

Figure 6. Normalized On-Resistance vs Drain Current and Gate Voltage

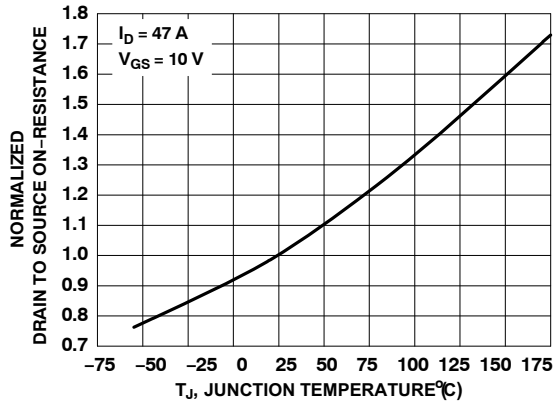

Figure 2. Normalized On-Resistance vs Junction Temperature

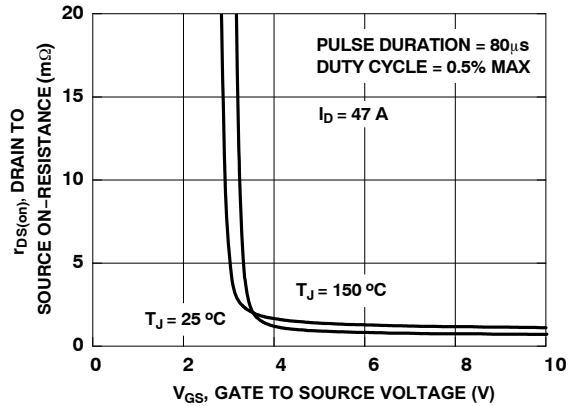

Figure 3. On-Resistance vs Gate to Source Voltage

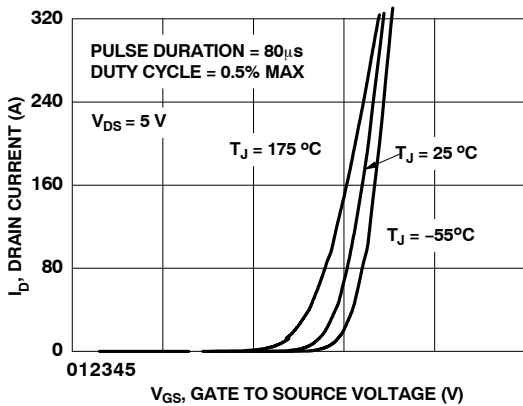

Figure 4. Transfer Characteristics

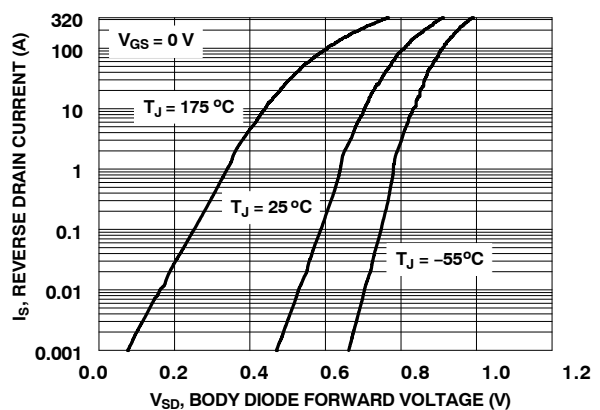

Figure 5. Source to Drain Diode Forward Voltage vs Source Current

FDMS8350LET40

TYPICAL CHARACTERISTICS

($T_J = 25^\circ\text{C}$ unless otherwise noted)

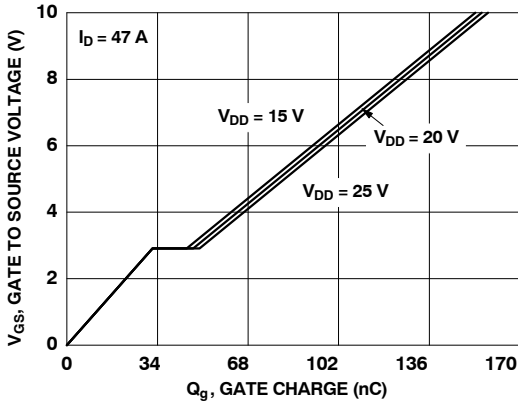

Figure 7. Gate Charge Characteristics

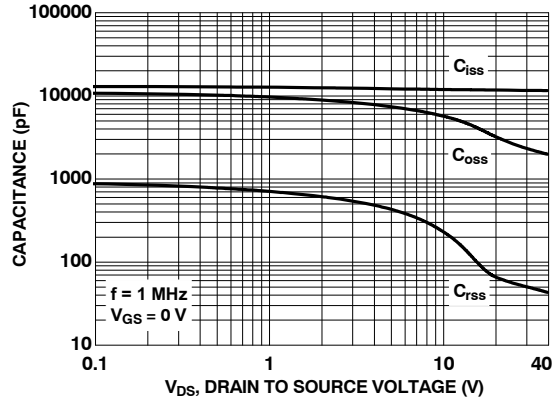

Figure 8. Capacitance vs Drain to Source Voltage

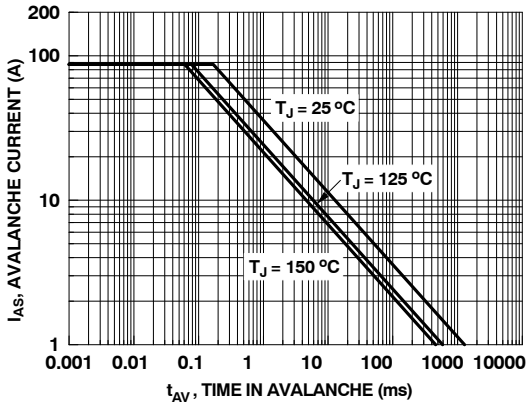

Figure 9. Unclamped Inductive Switching Capability

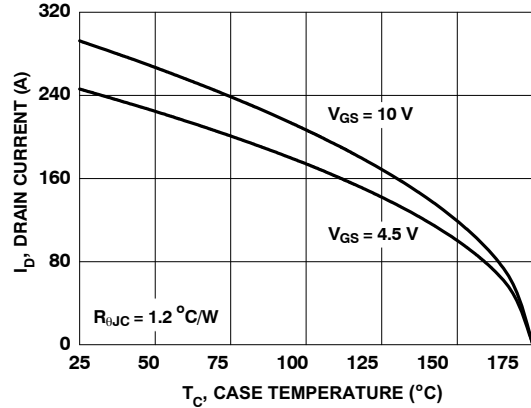

Figure 10. Maximum Continuous Drain Current vs Case Temperature

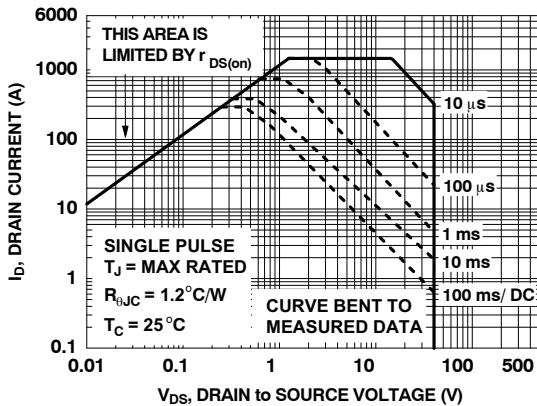

Figure 11. Forward Bias Safe Operating Area

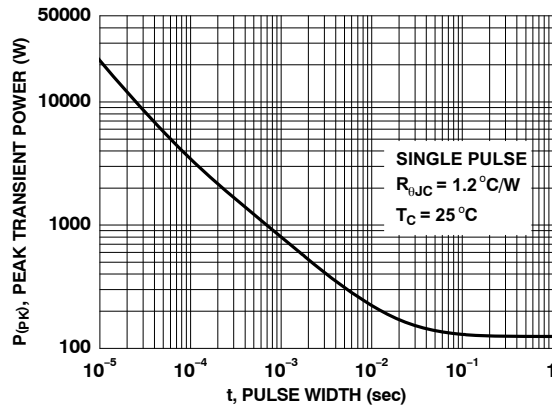

Figure 12. Single Pulse Maximum Power Dissipation

FDMS8350LET40

TYPICAL CHARACTERISTICS

($T_J = 25^\circ\text{C}$ unless otherwise noted)

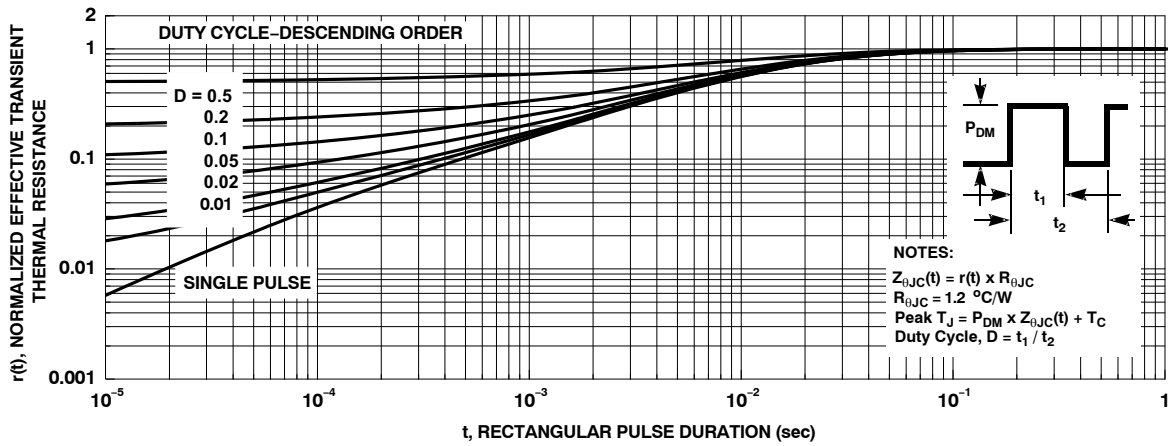

Figure 13. Junction-to-Case Transient Thermal Response Curve

MECHANICAL CASE OUTLINE

PACKAGE DIMENSIONS

ON Semiconductor®



PQFN8 5X6, 1.27P

CASE 483AG

ISSUE O

DATE 30 SEP 2016

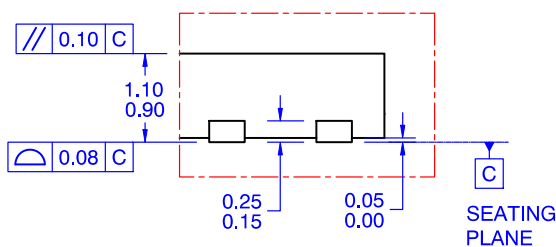
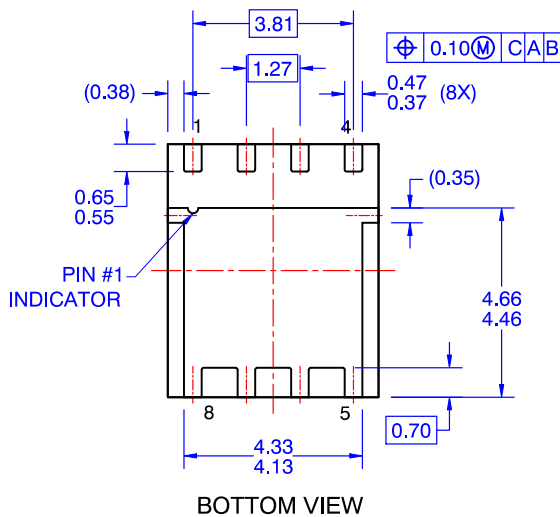
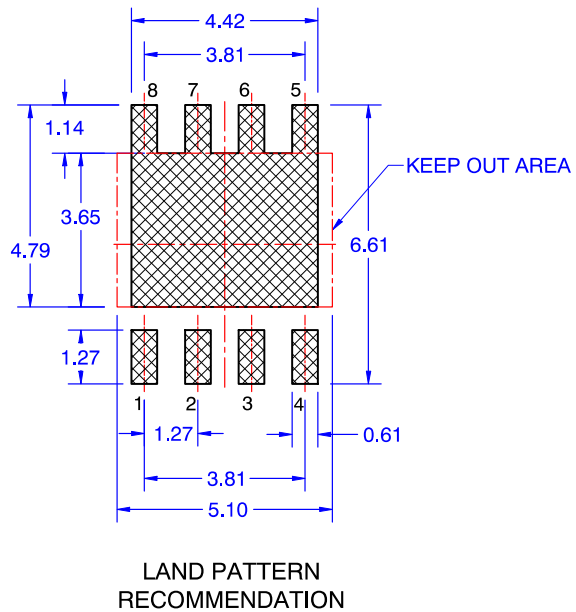
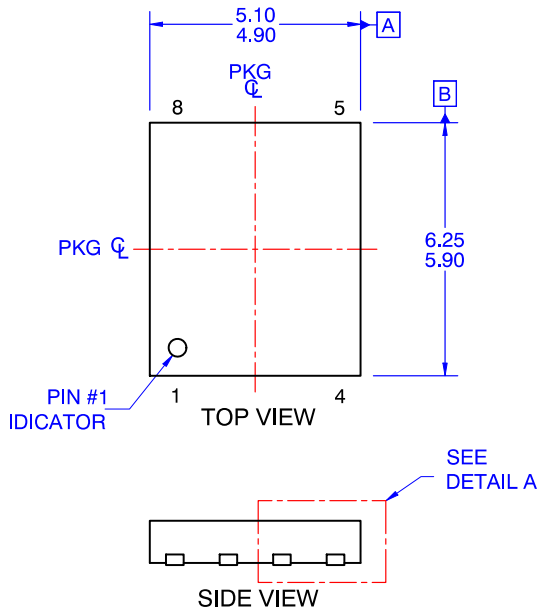

SCALE: 2:1

- NOTES: UNLESS OTHERWISE SPECIFIED
- A) PACKAGE STANDARD REFERENCE: JEDEC MO-240, ISSUE A, VAR. AA,
 - B) ALL DIMENSIONS ARE IN MILLIMETERS.
 - C) DIMENSIONS DO NOT INCLUDE BURRS OR MOLD FLASH. MOLD FLASH OR BURRS DOES NOT EXCEED 0.10MM.
 - D) DIMENSIONING AND TOLERANCING PER ASME Y14.5M-2009.
 - E) IT IS RECOMMENDED TO HAVE NO TRACES OR VIAS WITHIN THE KEEP OUT AREA.

DOCUMENT NUMBER:	98AON13657G	Electronic versions are uncontrolled except when accessed directly from the Document Repository. Printed versions are uncontrolled except when stamped "CONTROLLED COPY" in red.
DESCRIPTION:	PQFN8 5X6, 1.27P	PAGE 1 OF 1

ON Semiconductor and are trademarks of Semiconductor Components Industries, LLC dba ON Semiconductor or its subsidiaries in the United States and/or other countries. ON Semiconductor reserves the right to make changes without further notice to any products herein. ON Semiconductor makes no warranty, representation or guarantee regarding the suitability of its products for any particular purpose, nor does ON Semiconductor assume any liability arising out of the application or use of any product or circuit, and specifically disclaims any and all liability, including without limitation special, consequential or incidental damages. ON Semiconductor does not convey any license under its patent rights nor the rights of others.

ON Semiconductor and  are trademarks of Semiconductor Components Industries, LLC dba ON Semiconductor or its subsidiaries in the United States and/or other countries. ON Semiconductor owns the rights to a number of patents, trademarks, copyrights, trade secrets, and other intellectual property. A listing of ON Semiconductor's product/patent coverage may be accessed at www.onsemi.com/site/pdf/Patent-Marking.pdf. ON Semiconductor reserves the right to make changes without further notice to any products herein. ON Semiconductor makes no warranty, representation or guarantee regarding the suitability of its products for any particular purpose, nor does ON Semiconductor assume any liability arising out of the application or use of any product or circuit, and specifically disclaims any and all liability, including without limitation special, consequential or incidental damages. Buyer is responsible for its products and applications using ON Semiconductor products, including compliance with all laws, regulations and safety requirements or standards, regardless of any support or applications information provided by ON Semiconductor. "Typical" parameters which may be provided in ON Semiconductor data sheets and/or specifications can and do vary in different applications and actual performance may vary over time. All operating parameters, including "Typicals" must be validated for each customer application by customer's technical experts. ON Semiconductor does not convey any license under its patent rights nor the rights of others. ON Semiconductor products are not designed, intended, or authorized for use as a critical component in life support systems or any FDA Class 3 medical devices or medical devices with a same or similar classification in a foreign jurisdiction or any devices intended for implantation in the human body. Should Buyer purchase or use ON Semiconductor products for any such unintended or unauthorized application, Buyer shall indemnify and hold ON Semiconductor and its officers, employees, subsidiaries, affiliates, and distributors harmless against all claims, costs, damages, and expenses, and reasonable attorney fees arising out of, directly or indirectly, any claim of personal injury or death associated with such unintended or unauthorized use, even if such claim alleges that ON Semiconductor was negligent regarding the design or manufacture of the part. ON Semiconductor is an Equal Opportunity/Affirmative Action Employer. This literature is subject to all applicable copyright laws and is not for resale in any manner.

PUBLICATION ORDERING INFORMATION

LITERATURE FULFILLMENT:

Email Requests to: orderlit@onsemi.com

ON Semiconductor Website: www.onsemi.com

TECHNICAL SUPPORT

North American Technical Support:
Voice Mail: 1 800-282-9855 Toll Free USA/Canada
Phone: 011 421 33 790 2910

Europe, Middle East and Africa Technical Support:

Phone: 00421 33 790 2910

For additional information, please contact your local Sales Representative