

MOSFET – N-Channel, SUPERFET® II

800 V, 46 A, 85 mΩ



ON Semiconductor®

www.onsemi.com

FCH085N80

Description

SuperFET II MOSFET is ON Semiconductor's brand-new high voltage super-junction (SJ) MOSFET family that is utilizing charge balance technology for outstanding low on-resistance and lower gate charge performance. This technology is tailored to minimize conduction loss, provide superior switching performance, dv/dt rate and higher avalanche energy. Consequently, SuperFET II MOSFET is very suitable for the switching power applications such as PFC, server/telecom power, FPD TV power, ATX power and industrial power applications.

Features

- Typ. $R_{DS(on)}$ = 67 mΩ
- 850 V @ $T_J = 150^\circ\text{C}$
- Ultra Low Gate Charge (Typ. $Q_g = 196$ nC)
- Low E_{OSS} (Typ. 18 μJ @ 400 V)
- Low Effective Output Capacitance (Typ. $C_{oss(eff.)} = 568$ pF)
- 100% Avalanche Tested
- These Devices are Pb-Free and are RoHS Compliant

Applications

- AC-DC Power Supply
- LED Lighting

| V_{DS} | $R_{DS(on)}$ MAX | I_D MAX |
|----------|------------------|-----------|
| 800 V | 85 mΩ @ 10 V | 46 A |



N-CHANNEL MOSFET

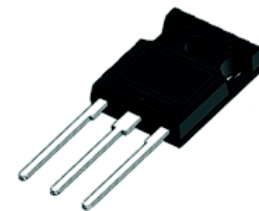

TO-247-3LD
CASE 340CH

MARKING DIAGRAM

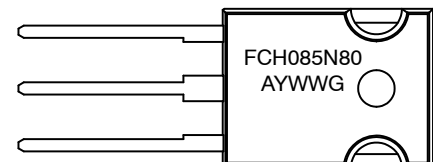

FCH085N80 = Specific Device Code
 A = Assembly Location
 Y = Year
 WW = Work Week
 G = Pb-Free Package

ORDERING INFORMATION

See detailed ordering and shipping information on page 2 of this data sheet.

FCH085N80

ABSOLUTE MAXIMUM RATINGS (T_C = 25°C unless otherwise noted)

| Symbol | Parameter | Value | Unit |
|-----------------------------------|--|---------------------------------------|------|
| V _{DSS} | Drain to Source Voltage | 800 | V |
| V _{GSS} | Gate to Source Voltage | - DC | ±20 |
| | | - AC (f > 1 Hz) | ±30 |
| I _D | Drain Current: | - Continuous (T _C = 25°C) | 46 |
| | | - Continuous (T _C = 100°C) | 29 |
| I _{DM} | Drain Current: | - Pulsed (Note 1) | 138 |
| E _{AS} | Single Pulsed Avalanche Energy (Note 2) | 1701 | mJ |
| I _{AS} | Avalanche Current (Note 2) | 9.2 | A |
| E _{AR} | Repetitive Avalanche Energy (Note 1) | 4.4 | mJ |
| dv/dt | MOSFET dv/dt | 100 | V/ns |
| | Peak Diode Recovery dv/dt (Note 3) | 20 | |
| P _D | Power Dissipation | (T _C = 25°C) | 446 |
| | | Derate Above 25°C | 3.5 |
| T _J , T _{STG} | Operating and Storage Temperature Range | -55 to + 150 | °C |
| T _L | Maximum Lead Temperature for Soldering, 1/8" from Case for 5 seconds | 300 | °C |

Stresses exceeding those listed in the Maximum Ratings table may damage the device. If any of these limits are exceeded, device functionality should not be assumed, damage may occur and reliability may be affected.

1. Repetitive rating: pulse-width limited by maximum junction temperature.
2. I_{AS} = 9.2 A, V_{DD} = 50 V, R_G = 25 Ω, starting T_J = 25 °C.
3. I_{SD} ≤ 46 A, di/dt ≤ 200 A/μs, V_{DD} ≤ BV_{DSS}, starting T_J = 25 °C.

PACKAGE MARKING AND ORDERING INFORMATION

| Part Number | Top Marking | Package | Packing Method | Reel Size | Tape Width | Quantity |
|----------------|-------------|------------|----------------|-----------|------------|----------|
| FCH085N80-F155 | FCH085N80 | TO-247 G03 | Tube | N/A | N/A | 30 Units |

THERMAL CHARACTERISTICS

| Symbol | Parameter | FCH085N80-F155 | Unit |
|------------------|---|----------------|------|
| R _{θJC} | Thermal Resistance, Junction to Case, Max. | 0.28 | °C/W |
| R _{θJA} | Thermal Resistance, Junction to Ambient, Max. | 40.0 | |

FCH085N80

ELECTRICAL CHARACTERISTICS (T_C = 25°C unless otherwise noted)

| Symbol | Parameter | Test Condition | Min. | Typ. | Max. | Unit |
|--------|-----------|----------------|------|------|------|------|
|--------|-----------|----------------|------|------|------|------|

OFF CHARACTERISTICS

| | | | | | | |
|-------------------------------------|---|---|-----|-----|------|------|
| BV _{DSS} | Drain to Source Breakdown Voltage | V _{GS} = 0 V, I _D = 1 mA, T _J = 25°C | 800 | – | – | V |
| ΔBV _{DSS} /ΔT _J | Breakdown Voltage Temperature Coefficient | I _D = 1 mA, Referenced to 25°C | – | 0.8 | – | V/°C |
| I _{DSS} | Zero Gate Voltage Drain Current | V _{DS} = 80 V, V _{GS} = 0 V | – | – | 25 | μA |
| | | V _{DS} = 640 V, V _{GS} = 0 V, T _C = 125 °C | – | – | 250 | |
| I _{GSS} | Gate to Body Leakage Current | V _{GS} = ±20 V, V _{DS} = 0 V | – | – | ±100 | nA |

ON CHARACTERISTICS

| | | | | | | |
|---------------------|--------------------------------------|---|-----|----|-----|----|
| V _{GS(th)} | Gate Threshold Voltage | V _{GS} = V _{DS} , I _D = 4.6 mA | 2.5 | – | 4.5 | V |
| R _{DS(on)} | Static Drain to Source On Resistance | V _{GS} = 10 V, I _D = 23 A | – | 67 | 85 | mΩ |
| g _{FS} | Forward Transconductance | V _{DS} = 20 V, I _D = 23 A | – | 55 | – | S |

DYNAMIC CHARACTERISTICS

| | | | | | | |
|------------------------|-------------------------------|---|---|------|-------|----|
| C _{iss} | Input Capacitance | V _{DS} = 100 V, V _{GS} = 0 V, f = 1 MHz | – | 8140 | 10825 | pF |
| C _{oss} | Output Capacitance | | – | 255 | 340 | pF |
| C _{rss} | Reverse Transfer Capacitance | | – | 10 | – | pF |
| C _{oss} | Output Capacitance | V _{DS} = 480 V, V _{GS} = 0 V, f = 1 MHz | – | 1000 | – | pF |
| C _{oss(eff.)} | Effective Output Capacitance | V _{DS} = 0 V to 480 V, V _{GS} = 0 V | – | 728 | – | pF |
| Q _{g(tot)} | Total Gate Charge at 10 V | V _{DS} = 640 V, I _D = 46 A, V _{GS} = 10 V (Note 4) | – | 196 | 255 | nC |
| Q _{gs} | Gate to Source Gate Charge | | – | 40 | – | nC |
| Q _{gd} | Gate to Drain “Miller” Charge | | – | 72 | – | nC |
| ESR | Equivalent Series Resistance | f = 1 MHz | – | 0.8 | – | Ω |

SWITCHING CHARACTERISTICS

| | | | | | | |
|---------------------|---------------------|---|---|-----|-----|----|
| t _{d(on)} | Turn-On Delay Time | V _{DD} = 400 V, I _D = 46 A, V _{GS} = 10 V, R _g = 4.7 Ω (Note 4) | – | 45 | 100 | ns |
| t _r | Turn-On Rise Time | | – | 55 | 120 | ns |
| t _{d(off)} | Turn-Off Delay Time | | – | 160 | 330 | ns |
| t _f | Turn-Off Fall Time | | – | 35 | 80 | ns |

DRAIN-SOURCE DIODE CHARACTERISTICS

| | | | | | | |
|-----------------|--|---|---|-----|-----|----|
| I _S | Maximum Continuous Source to Drain Diode Forward Current | – | – | 46 | A | |
| I _{SM} | Maximum Pulsed Drain to Source Diode Forward Current | – | – | 138 | A | |
| V _{SD} | Drain to Source Diode Forward Voltage | V _{GS} = 0 V, I _{SD} = 46 A | – | – | 1.2 | V |
| t _{rr} | Reverse Recovery Time | V _{GS} = 0 V, I _{SD} = 46 A, di _F /dt = 100 A/μs | – | 800 | – | ns |
| Q _{rr} | Reverse Recovery Charge | | – | 32 | – | μC |

Product parametric performance is indicated in the Electrical Characteristics for the listed test conditions, unless otherwise noted. Product performance may not be indicated by the Electrical Characteristics if operated under different conditions.

4. Essentially independent of operating temperature typical characteristics.

TYPICAL CHARACTERISTICS

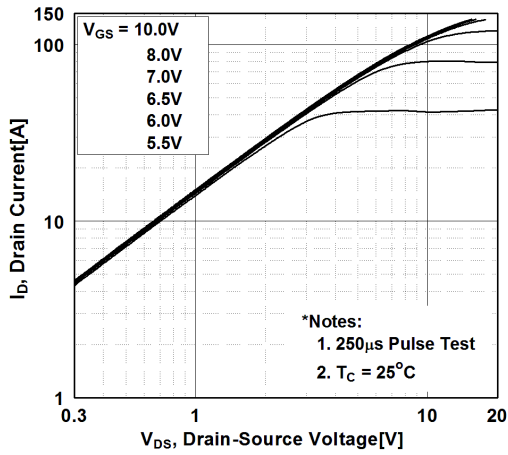

Figure 1. On-Region Characteristics

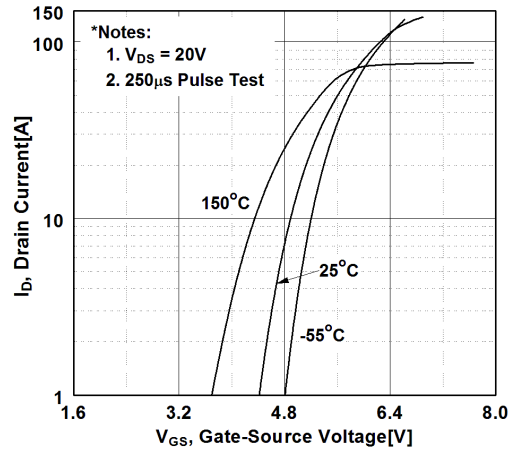

Figure 2. Transfer Characteristics

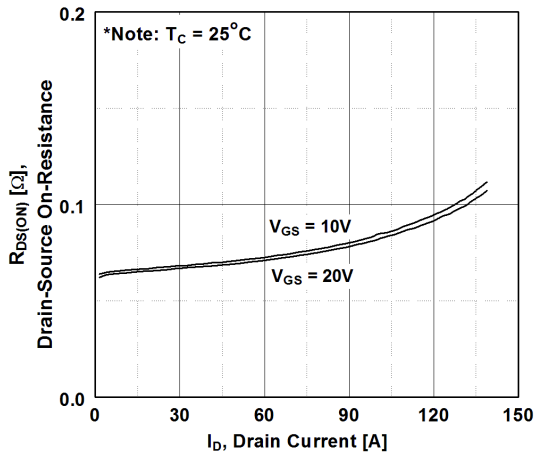

Figure 3. On-Resistance Variation vs. Drain Current and Gate Voltage

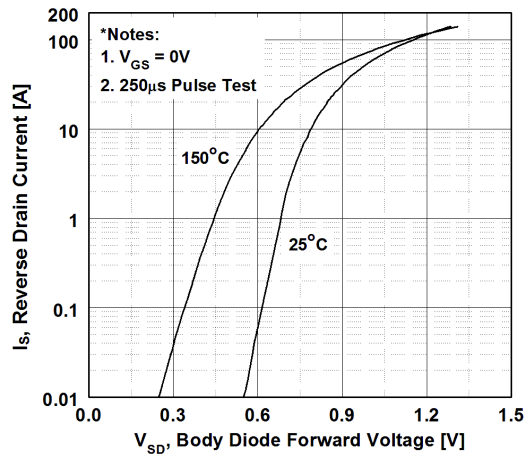

Figure 4. Body Diode Forward Voltage Variation vs. Source Current and Temperature

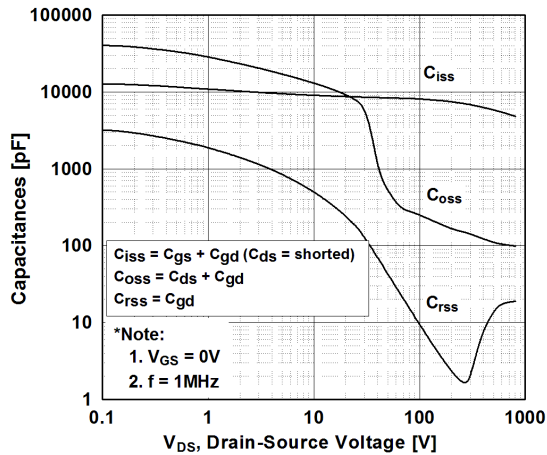

Figure 5. Capacitance Characteristics

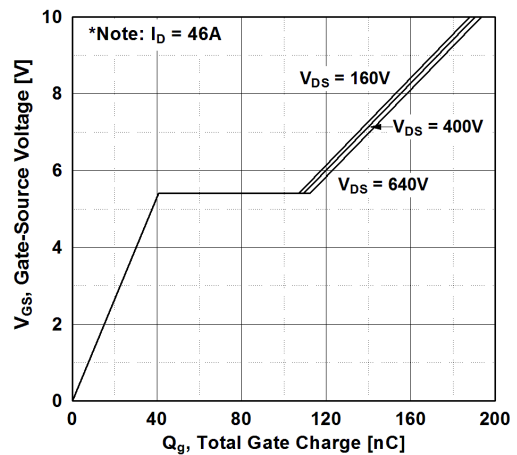

Figure 6. Gate Charge Characteristics

TYPICAL CHARACTERISTICS

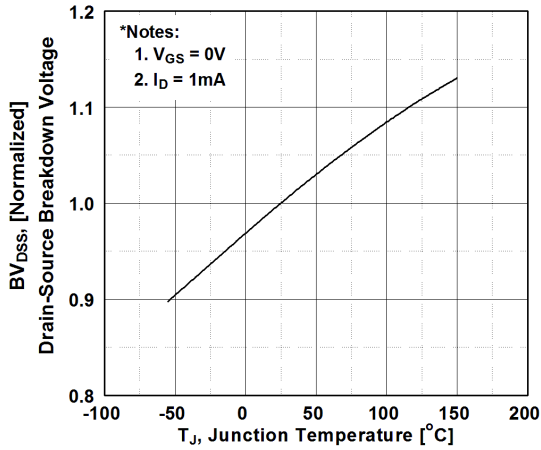

Figure 7. Breakdown Voltage Variation vs. Temperature

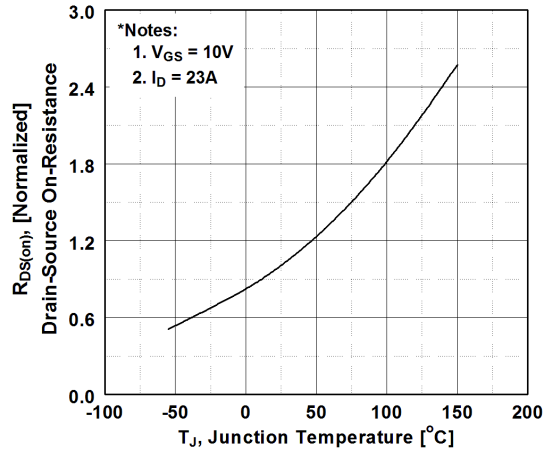

Figure 8. On-Resistance Variation vs. Temperature

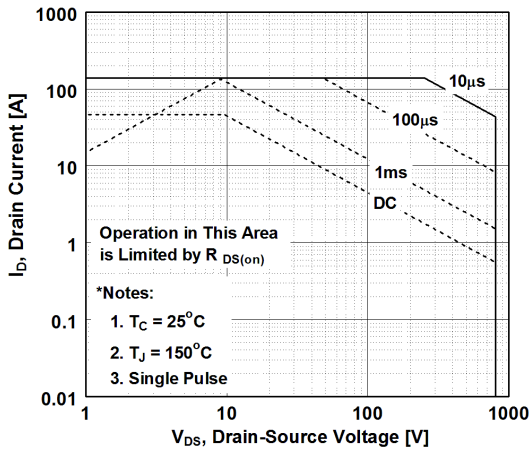

Figure 9. Maximum Safe Operating Area

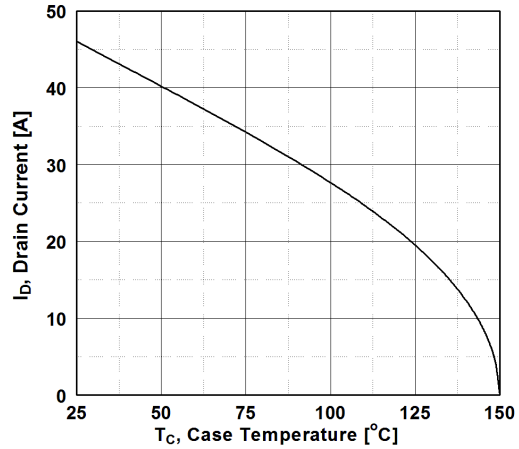

Figure 10. Maximum Drain Current vs. Case Temperature

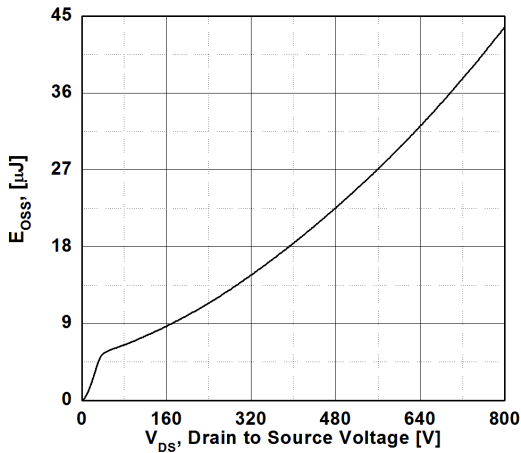

Figure 11. E_{oss} vs. Drain to Source Voltage

TYPICAL CHARACTERISTICS

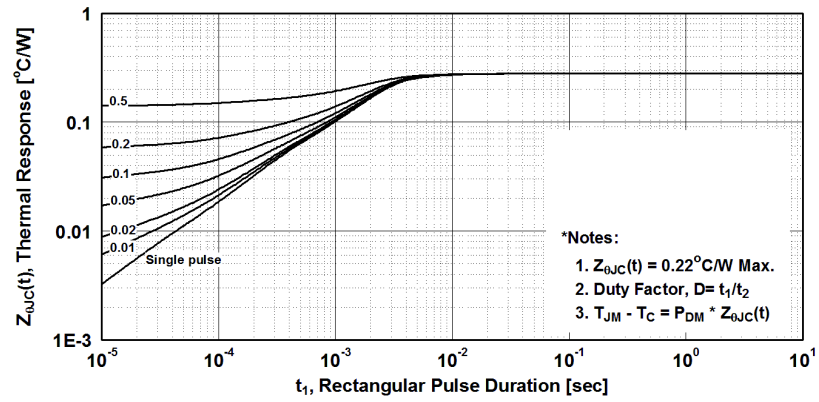

Figure 12. Transient Thermal Response Curve

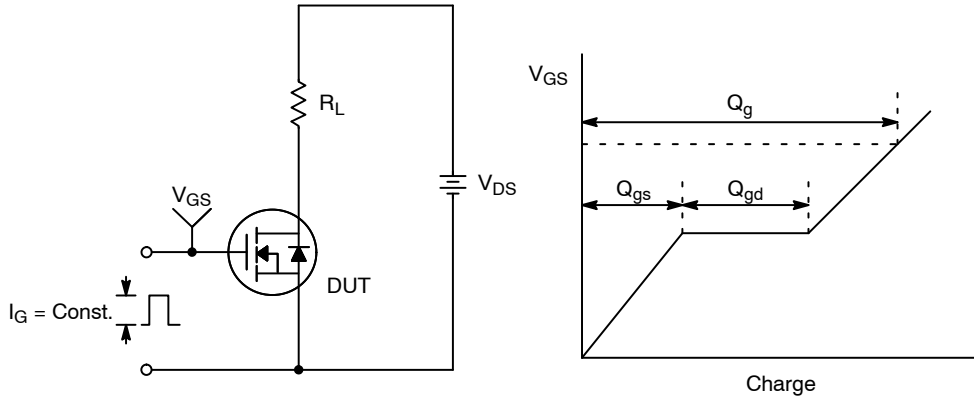

Figure 13. Gate Charge Test Circuit & Waveform

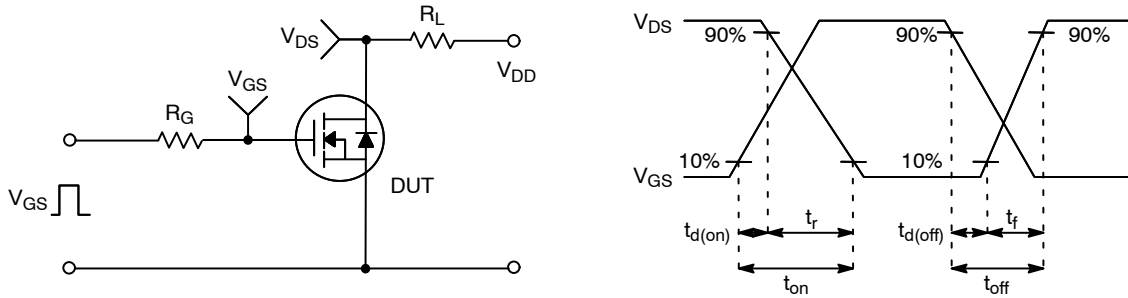

Figure 14. Resistive Switching Test Circuit & Waveforms

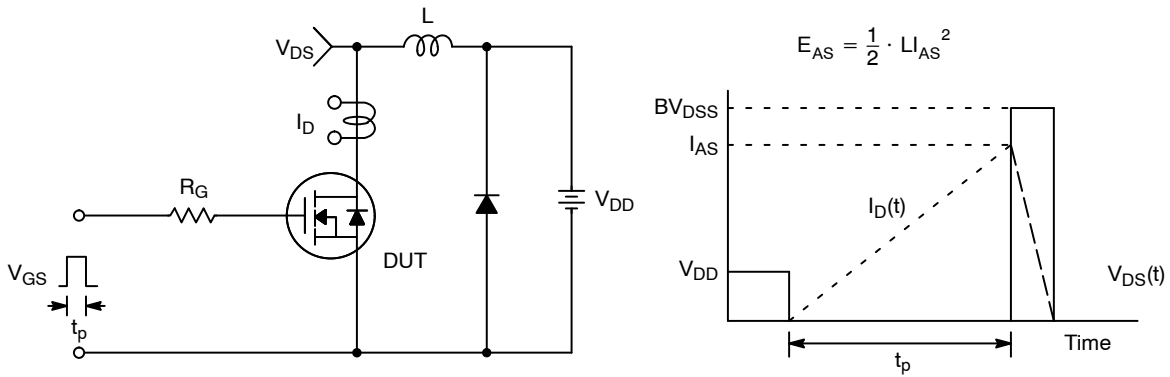

Figure 15. Unclamped Inductive Switching Test Circuit & Waveforms

FCH085N80

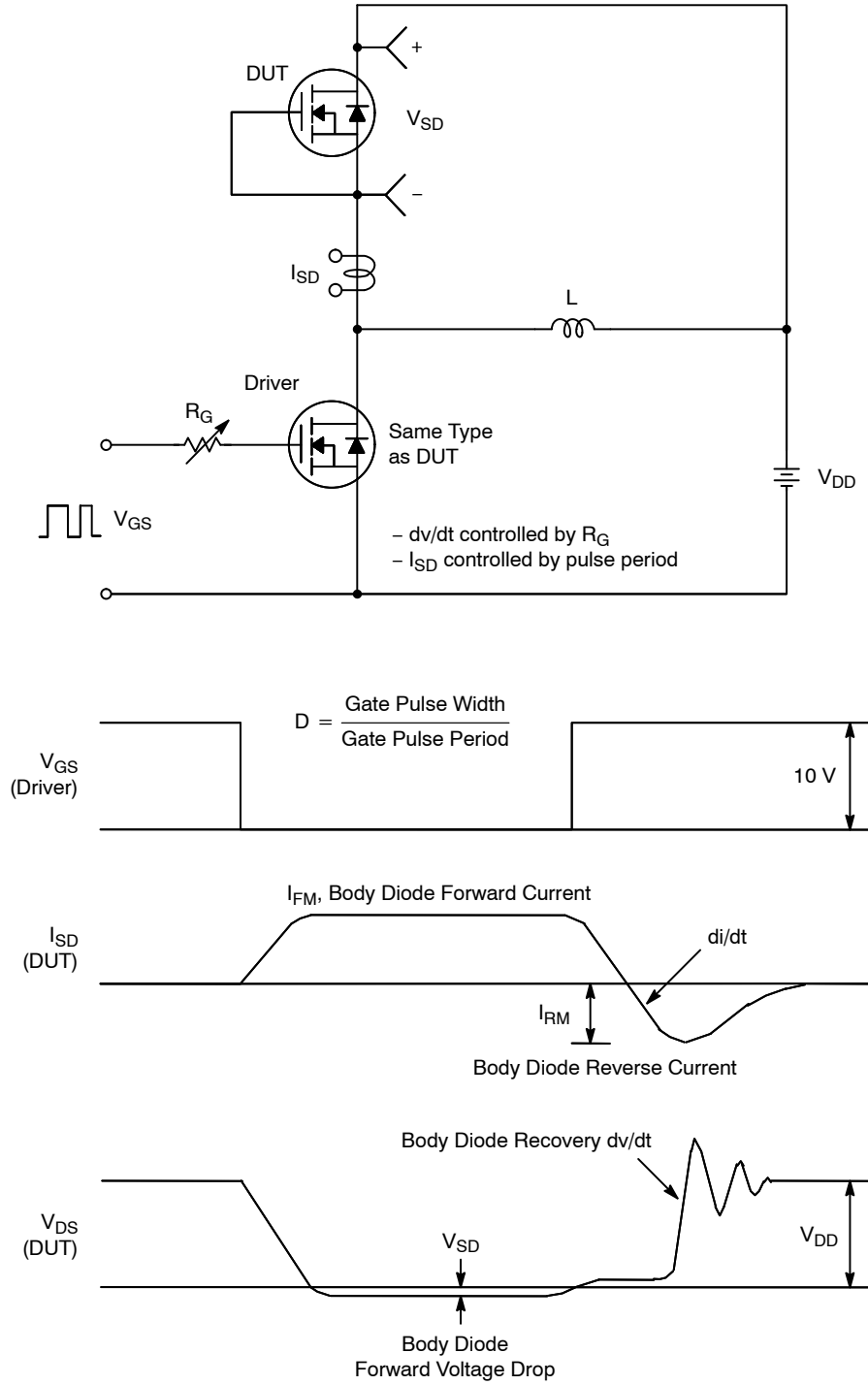

Figure 16. Peak Diode Recovery dv/dt Test Circuit & Waveforms

SUPERFET is a registered trademark of Semiconductor Components Industries, LLC (SCILLC) or its subsidiaries in the United States and/or other countries.

MECHANICAL CASE OUTLINE

PACKAGE DIMENSIONS

ON Semiconductor®



TO-247-3LD
CASE 340CH
ISSUE A

DATE 09 OCT 2019



NOTES: UNLESS OTHERWISE SPECIFIED.

- A. DIMENSIONS ARE EXCLUSIVE OF BURRS, MOLD FLASH, AND TIE BAR EXTRUSIONS.
- B. ALL DIMENSIONS ARE IN MILLIMETERS.
- C. DRAWING CONFORMS TO ASME Y14.5 - 2009.
- D. DIMENSION A1 TO BE MEASURED IN THE REGION DEFINED BY L1.
- E. LEAD FINISH IS UNCONTROLLED IN THE REGION DEFINED BY L1.

GENERIC MARKING DIAGRAM*



XXXX = Specific Device Code
A = Assembly Location
Y = Year
WW = Work Week
G = Pb-Free Package

*This information is generic. Please refer to device data sheet for actual part marking. Pb-Free indicator, "G" or microdot "•", may or may not be present. Some products may not follow the Generic Marking.

| DIM | MILLIMETERS | | |
|-----|-------------|-------|-------|
| | MIN | NOM | MAX |
| A | 4.58 | 4.70 | 4.82 |
| A1 | 2.29 | 2.475 | 2.66 |
| A2 | 1.40 | 1.50 | 1.60 |
| D | 20.32 | 20.57 | 20.82 |
| E | 15.37 | 15.62 | 15.87 |
| E2 | 4.96 | 5.08 | 5.20 |
| e | ~ | 5.56 | ~ |
| L | 19.75 | 20.00 | 20.25 |
| L1 | 3.69 | 3.81 | 3.93 |
| ∅P | 3.51 | 3.58 | 3.65 |
| Q | 5.34 | 5.46 | 5.58 |
| S | 5.34 | 5.46 | 5.58 |
| b | 1.17 | 1.26 | 1.35 |
| b2 | 1.53 | 1.65 | 1.77 |
| b4 | 2.42 | 2.54 | 2.66 |
| c | 0.51 | 0.61 | 0.71 |
| D1 | 13.08 | ~ | ~ |
| D2 | 0.51 | 0.93 | 1.35 |
| E1 | 12.81 | ~ | ~ |
| ∅P1 | 6.61 | 6.73 | 6.85 |

| | | |
|-------------------------|--------------------|---|
| DOCUMENT NUMBER: | 98AON13853G | Electronic versions are uncontrolled except when accessed directly from the Document Repository. Printed versions are uncontrolled except when stamped "CONTROLLED COPY" in red. |
| DESCRIPTION: | TO-247-3LD | PAGE 1 OF 1 |

ON Semiconductor and are trademarks of Semiconductor Components Industries, LLC dba ON Semiconductor or its subsidiaries in the United States and/or other countries. ON Semiconductor reserves the right to make changes without further notice to any products herein. ON Semiconductor makes no warranty, representation or guarantee regarding the suitability of its products for any particular purpose, nor does ON Semiconductor assume any liability arising out of the application or use of any product or circuit, and specifically disclaims any and all liability, including without limitation special, consequential or incidental damages. ON Semiconductor does not convey any license under its patent rights nor the rights of others.

ON Semiconductor and  are trademarks of Semiconductor Components Industries, LLC dba ON Semiconductor or its subsidiaries in the United States and/or other countries. ON Semiconductor owns the rights to a number of patents, trademarks, copyrights, trade secrets, and other intellectual property. A listing of ON Semiconductor's product/patent coverage may be accessed at www.onsemi.com/site/pdf/Patent-Marking.pdf. ON Semiconductor reserves the right to make changes without further notice to any products herein. ON Semiconductor makes no warranty, representation or guarantee regarding the suitability of its products for any particular purpose, nor does ON Semiconductor assume any liability arising out of the application or use of any product or circuit, and specifically disclaims any and all liability, including without limitation special, consequential or incidental damages. Buyer is responsible for its products and applications using ON Semiconductor products, including compliance with all laws, regulations and safety requirements or standards, regardless of any support or applications information provided by ON Semiconductor. "Typical" parameters which may be provided in ON Semiconductor data sheets and/or specifications can and do vary in different applications and actual performance may vary over time. All operating parameters, including "Typicals" must be validated for each customer application by customer's technical experts. ON Semiconductor does not convey any license under its patent rights nor the rights of others. ON Semiconductor products are not designed, intended, or authorized for use as a critical component in life support systems or any FDA Class 3 medical devices or medical devices with a same or similar classification in a foreign jurisdiction or any devices intended for implantation in the human body. Should Buyer purchase or use ON Semiconductor products for any such unintended or unauthorized application, Buyer shall indemnify and hold ON Semiconductor and its officers, employees, subsidiaries, affiliates, and distributors harmless against all claims, costs, damages, and expenses, and reasonable attorney fees arising out of, directly or indirectly, any claim of personal injury or death associated with such unintended or unauthorized use, even if such claim alleges that ON Semiconductor was negligent regarding the design or manufacture of the part. ON Semiconductor is an Equal Opportunity/Affirmative Action Employer. This literature is subject to all applicable copyright laws and is not for resale in any manner.

PUBLICATION ORDERING INFORMATION

LITERATURE FULFILLMENT:

Email Requests to: orderlit@onsemi.com

ON Semiconductor Website: www.onsemi.com

TECHNICAL SUPPORT

North American Technical Support:
Voice Mail: 1 800-282-9855 Toll Free USA/Canada
Phone: 011 421 33 790 2910

Europe, Middle East and Africa Technical Support:

Phone: 00421 33 790 2910

For additional information, please contact your local Sales Representative