

MOSFET – N-Channel, SUPERFET[®], FRFET[®]

600 V, 47 A, 73 mΩ

FCA47N60F

Description

SUPERFET MOSFET is onsemi's first generation of high voltage super-junction (SJ) MOSFET family that is utilizing charge balance technology for outstanding low on-resistance and lower gate charge performance. This technology is tailored to minimize conduction loss, provide superior switching performance, dv/dt rate and higher avalanche energy. Consequently, SUPERFET MOSFET is very suitable for the switching power applications such as PFC, server/telecom power, FPD TV power, ATX power and industrial power applications. SUPERFET FRFET MOSFET's optimized body diode reverse recovery performance can remove additional component and improve system reliability.

Features

- 650 V @ $T_J = 150^{\circ}\text{C}$
- Typ. $R_{DS(on)} = 62\text{ m}\Omega$
- Fast Recovery Time (Typ. $T_{rr} = 240\text{ ns}$)
- Ultra Low Gate Charge (Typ. $Q_g = 210\text{ nC}$)
- Low Effective Output Capacitance (Typ. $C_{oss(eff.)} = 420\text{ pF}$)
- 100% Avalanche Tested
- RoHS Compliant

Applications

- Solar Inverter
- AC-DC Power Supply

| V_{DSS} | $R_{DS(on)}\text{ MAX}$ | $I_D\text{ MAX}$ |
|-----------|-------------------------|------------------|
| 600 V | 73 mΩ @ 10 V | 47 A |

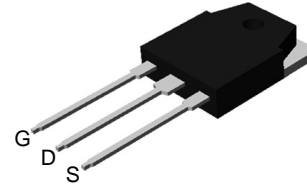

TO-3P-3LD / EIAJ SC-65, ISOLATED
 CASE 340BZ

MARKING DIAGRAM

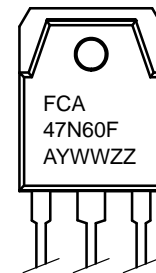

FCA47N60F = Specific Device Code
 A = Assembly Location
 YWW = Date Code (Year & Week)
 ZZ = Assembly Lot

N-CHANNEL MOSFET

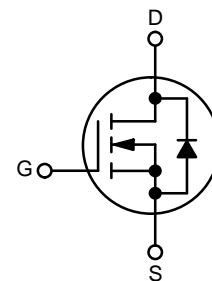

ORDERING INFORMATION

| Part Number | Package | Shipping |
|-------------|------------------------|------------------|
| FCA47N60F | TO-3P-3LD (Pb-Free) | 450 Units / Tube |

FCA47N60F

ABSOLUTE MAXIMUM RATINGS (T_C = 25°C, unless otherwise noted)

| Symbol | Parameter | FCA47N60F | Unit |
|-----------------------------------|--|---------------------------------------|------|
| V _{DSS} | Drain–Source Voltage | 600 | V |
| I _D | Drain Current | – Continuous (T _C = 25°C) | 47 |
| | | – Continuous (T _C = 100°C) | 29.7 |
| I _{DM} | Drain Current | – Pulsed (Note 1) | 141 |
| V _{GSS} | Gate–Source Voltage | ±30 | V |
| E _{AS} | Single Pulsed Avalanche Energy (Note 2) | 1800 | mJ |
| I _{AR} | Avalanche Current (Note 1) | 47 | A |
| E _{AR} | Repetitive Avalanche Energy (Note 1) | 41.7 | mJ |
| dv/dt | Peak Diode Recovery dv/dt (Note 3) | 50 | V/ns |
| P _D | Power Dissipation | (T _C = 25°C) | 417 |
| | | – Derate above 25°C | 3.33 |
| T _J , T _{STG} | Operating and Storage Temperature Range | –55 to +150 | °C |
| T _L | Maximum Lead Temperature for Soldering, 1/8" from Case for 5 Seconds | 300 | °C |

Stresses exceeding those listed in the Maximum Ratings table may damage the device. If any of these limits are exceeded, device functionality should not be assumed, damage may occur and reliability may be affected.

1. Repetitive rating: pulse–width limited by maximum junction temperature.
2. I_{AS} = 18 A, V_{DD} = 50 V, R_G = 25 Ω, starting T_J = 25°C.
3. I_{SD} ≤ 47 A, di/dt ≤ 1200 A/μs, V_{DD} ≤ BV_{DSS}, starting T_J = 25°C.

THERMAL CHARACTERISTICS

| Symbol | Parameter | FCA47N60F | Unit |
|------------------|---|-----------|------|
| R _{θJC} | Thermal Resistance, Junction–to–Case, Max. | 0.3 | °C/W |
| R _{θJA} | Thermal Resistance, Junction–to–Ambient, Max. | 41.7 | °C/W |

FCA47N60F

ELECTRICAL CHARACTERISTICS (T_C = 25°C unless otherwise noted)

| Symbol | Parameter | Conditions | Min | Typ | Max | Unit |
|--------------------------------------|---|--|-----|-----|------|------|
| OFF CHARACTERISTICS | | | | | | |
| BV _{DSS} | Drain–Source Breakdown Voltage | V _{GS} = 0 V, I _D = 250 μA, T _J = 25°C | 600 | – | – | V |
| | | V _{GS} = 0 V, I _D = 250 μA, T _J = 150°C | – | 650 | – | |
| ΔBV _{DSS} / ΔT _J | Breakdown Voltage Temperature Coefficient | I _D = 250 μA, Referenced to 25°C | – | 0.6 | – | V/°C |
| BV _{DS} | Drain to Source Avalanche Breakdown Voltage | V _{GS} = 0 V, I _D = 47 A | – | 700 | – | V |
| I _{DSS} | Zero Gate Voltage Drain Current | V _{DS} = 600 V, V _{GS} = 0 V | – | – | 10 | μA |
| | | V _{DS} = 480 V, T _C = 125°C | – | – | 100 | |
| I _{GSSF} | Gate–Body Leakage Current, Forward | V _{GS} = 30 V, V _{DS} = 0 V | – | – | 100 | nA |
| I _{GSSR} | Gate–Body Leakage Current, Reverse | V _{GS} = –30 V, V _{DS} = 0 V | – | – | –100 | nA |

ON CHARACTERISTICS

| | | | | | | |
|---------------------|-----------------------------------|---|-----|-------|-------|---|
| V _{GS(th)} | Gate Threshold Voltage | V _{DS} = V _{GS} , I _D = 250 μA | 3.0 | – | 5.0 | V |
| R _{DS(on)} | Static Drain–Source On–Resistance | V _{GS} = 10 V, I _D = 23.5 A | – | 0.062 | 0.073 | Ω |
| g _{FS} | Forward Transconductance | V _{DS} = 20 V, I _D = 23.5 A | – | 40 | – | S |

DYNAMIC CHARACTERISTICS

| | | | | | | |
|------------------------|------------------------------|---|---|------|------|----|
| C _{iss} | Input Capacitance | V _{DS} = 25 V, V _{GS} = 0 V, f = 1 MHz | – | 5900 | 8000 | pF |
| C _{oss} | Output Capacitance | | – | 3200 | 4200 | pF |
| C _{rss} | Reverse Transfer Capacitance | | – | 250 | – | pF |
| C _{oss} | Output Capacitance | V _{DS} = 480 V, V _{GS} = 0 V, f = 1 MHz | – | 160 | – | pF |
| C _{oss(eff.)} | Effective Output Capacitance | V _{DS} = 0 to 400 V, V _{GS} = 0 V | – | 420 | – | pF |

SWITCHING CHARACTERISTICS

| | | | | | | |
|---------------------|---------------------|--|---|-----|------|----|
| t _{d(on)} | Turn–On Delay Time | V _{DD} = 300 V, I _D = 47 A, V _{GS} = 10 V, R _G = 25 Ω (Note 4) | – | 185 | 430 | ns |
| t _r | Turn–On Rise Time | | – | 210 | 450 | ns |
| t _{d(off)} | Turn–Off Delay Time | | – | 520 | 1100 | ns |
| t _f | Turn–Off Fall Time | | – | 75 | 160 | ns |
| Q _g | Total Gate Charge | V _{DS} = 480 V, I _D = 47 A, V _{GS} = 10 V (Note 4) | – | 210 | 270 | nC |
| Q _{gs} | Gate–Source Charge | | – | 38 | – | nC |
| Q _{gd} | Gate–Drain Charge | | – | 110 | – | nC |

DRAIN–SOURCE DIODE CHARACTERISTICS AND MAXIMUM RATINGS

| | | | | | | |
|-----------------|---|--|---|------|-----|----|
| I _S | Maximum Continuous Drain–Source Diode Forward Current | – | – | 47 | A | |
| I _{SM} | Maximum Pulsed Drain–Source Diode Forward Current | – | – | 141 | A | |
| V _{SD} | Drain–Source Diode Forward Voltage | V _{GS} = 0 V, I _S = 47 A | – | – | 1.4 | V |
| t _{rr} | Reverse Recovery Time | V _{GS} = 0 V, I _S = 47 A, dI _F /dt = 100 A/μs | – | 240 | – | ns |
| Q _{rr} | Reverse Recovery Charge | | – | 2.04 | – | μC |

Product parametric performance is indicated in the Electrical Characteristics for the listed test conditions, unless otherwise noted. Product performance may not be indicated by the Electrical Characteristics if operated under different conditions.

4. Essentially independent of operating temperature typical characteristics.

TYPICAL PERFORMANCE CHARACTERISTICS

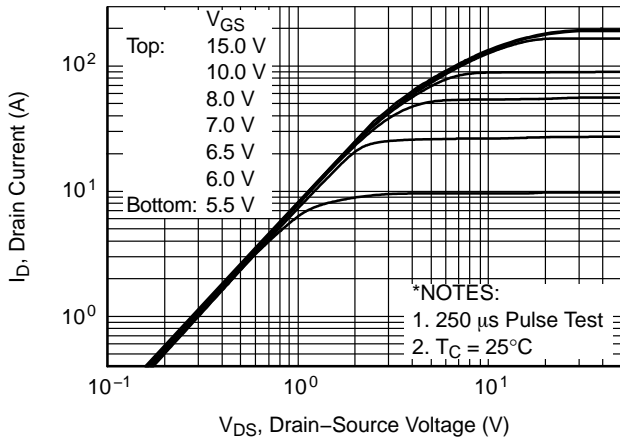

Figure 1. On-Region Characteristics

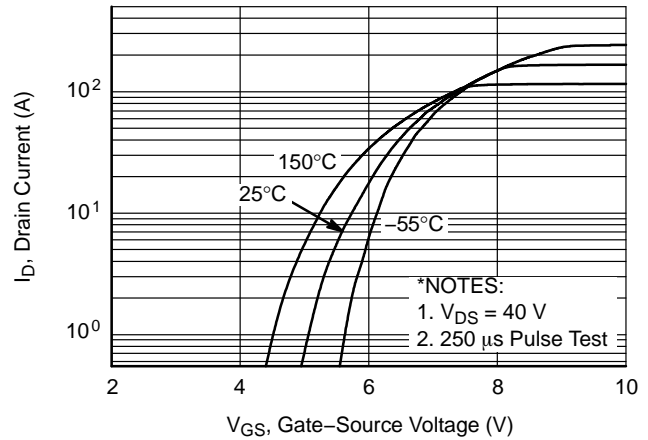

Figure 2. Transfer Characteristics

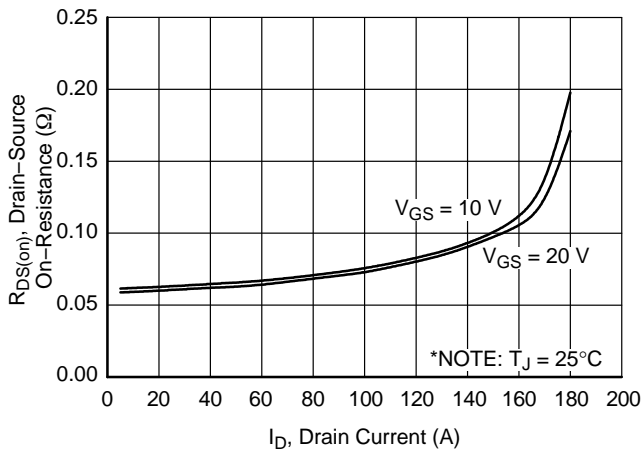

Figure 3. On-Resistance Variation vs. Drain Current and Gate Voltage

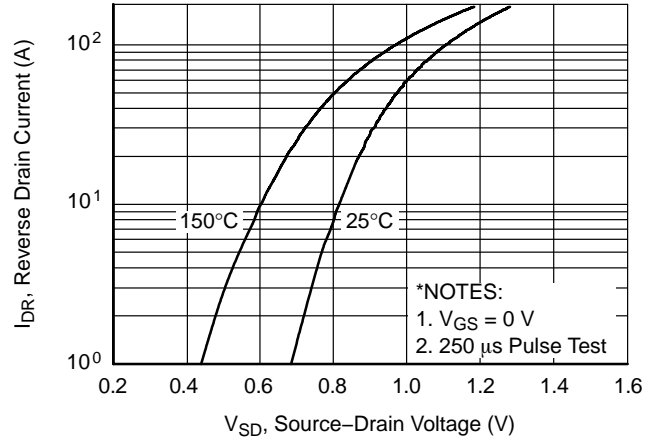

Figure 4. Body Diode Forward Voltage Variation vs. Source Current and Temperature

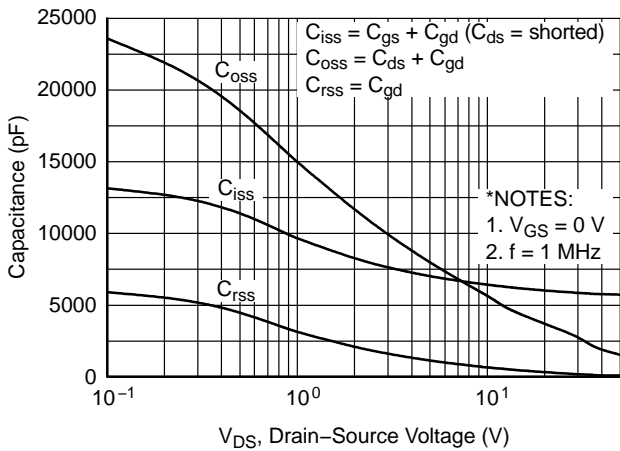

Figure 5. Capacitance Characteristics

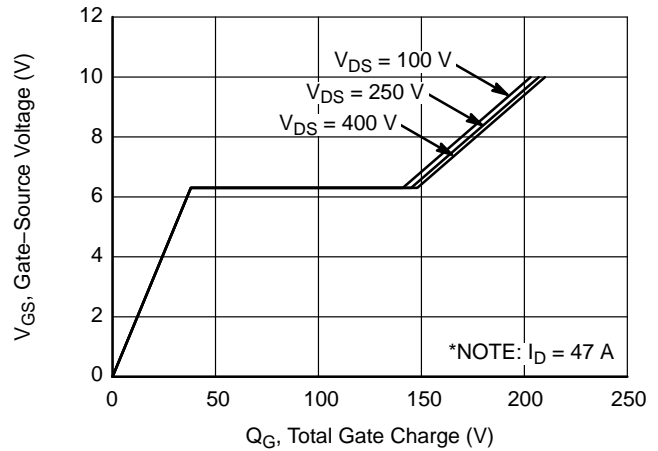

Figure 6. Gate Charge Characteristics

TYPICAL PERFORMANCE CHARACTERISTICS (CONTINUED)

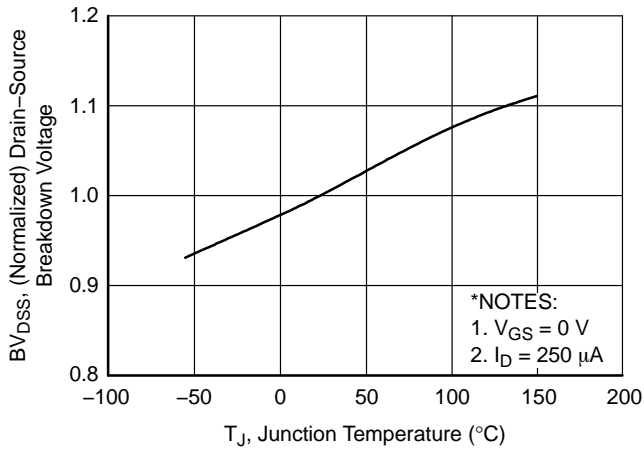

Figure 7. Breakdown Voltage Variation vs. Temperature

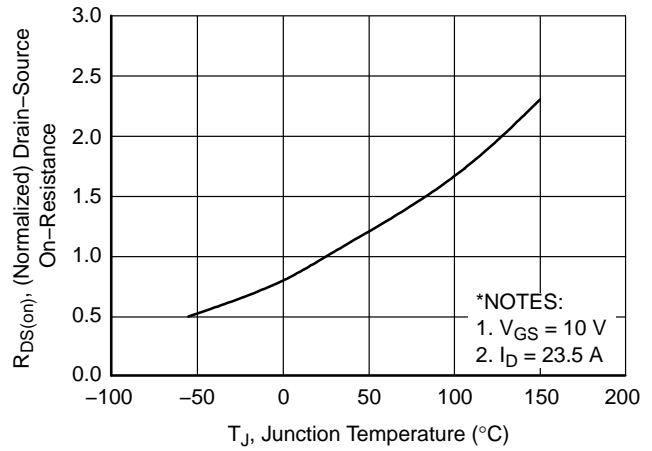

Figure 8. On-Resistance Variation vs. Temperature

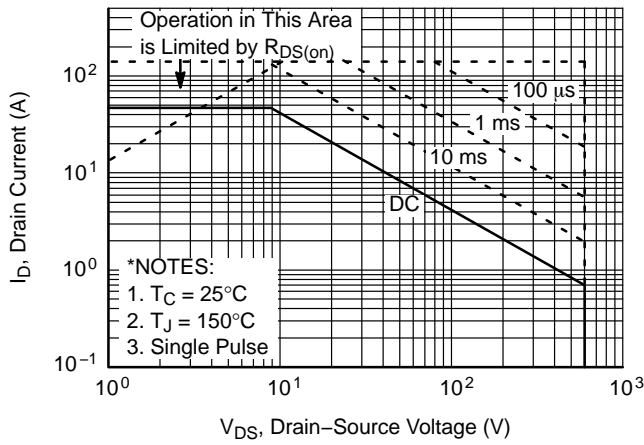

Figure 9. Safe Operating Area

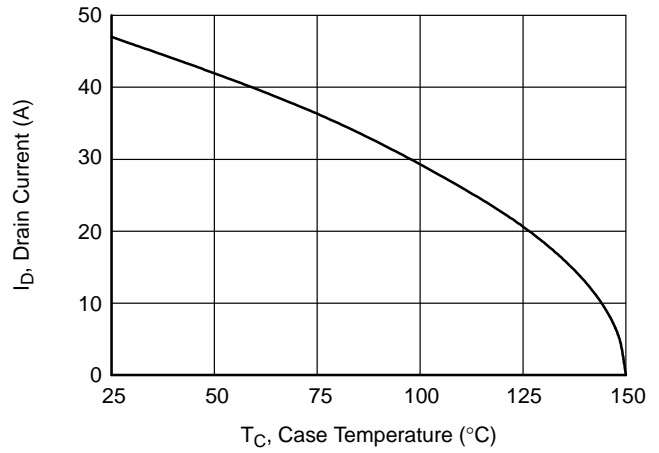

Figure 10. Maximum Drain Current vs. Case Temperature

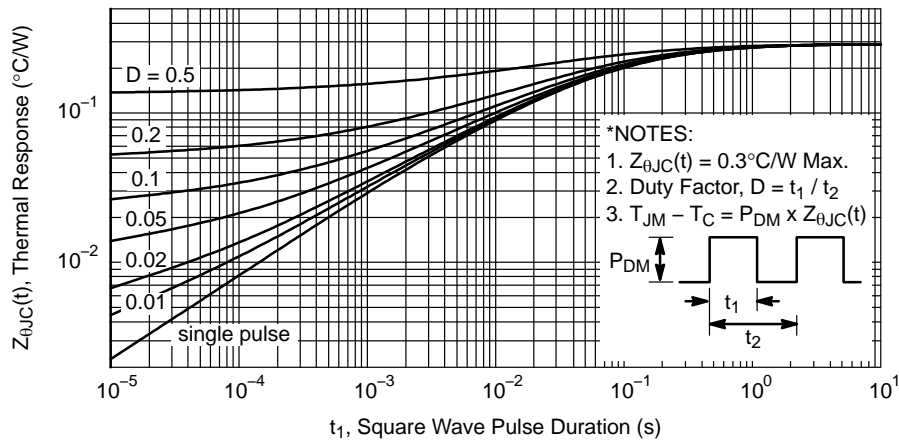

Figure 11. Transient Thermal Response Curve

FCA47N60F

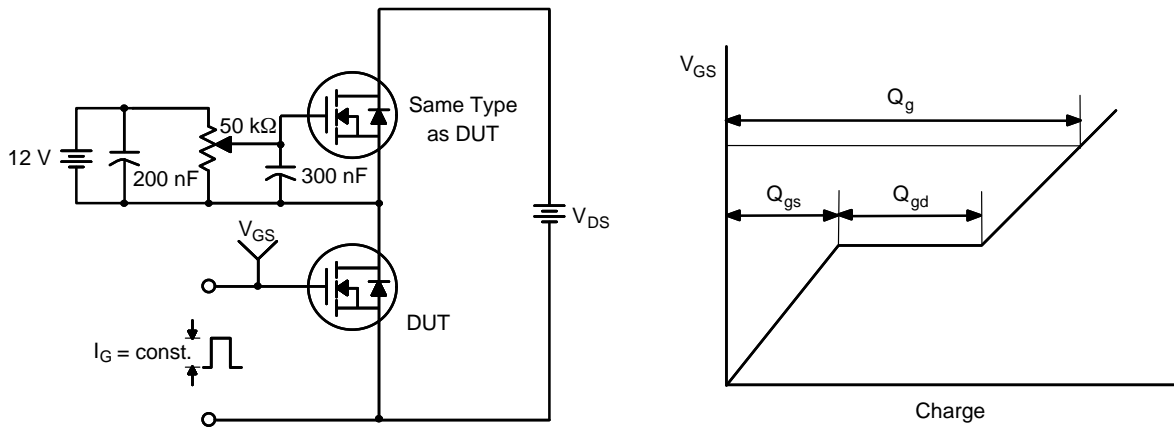

Figure 12. Gate Charge Test Circuit & Waveform

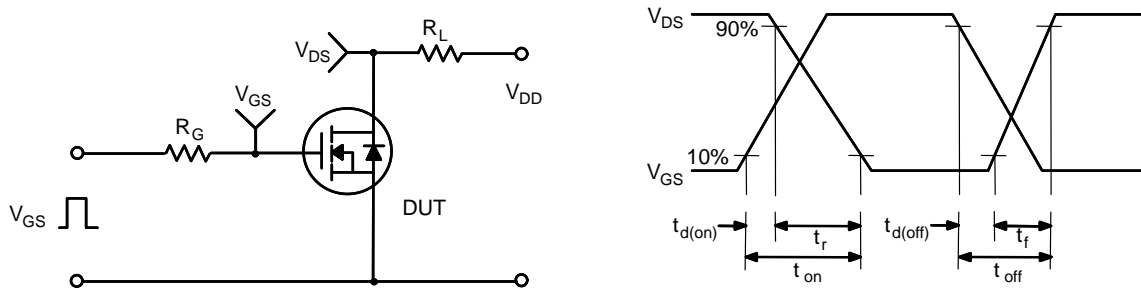

Figure 13. Resistive Switching Test Circuit & Waveforms

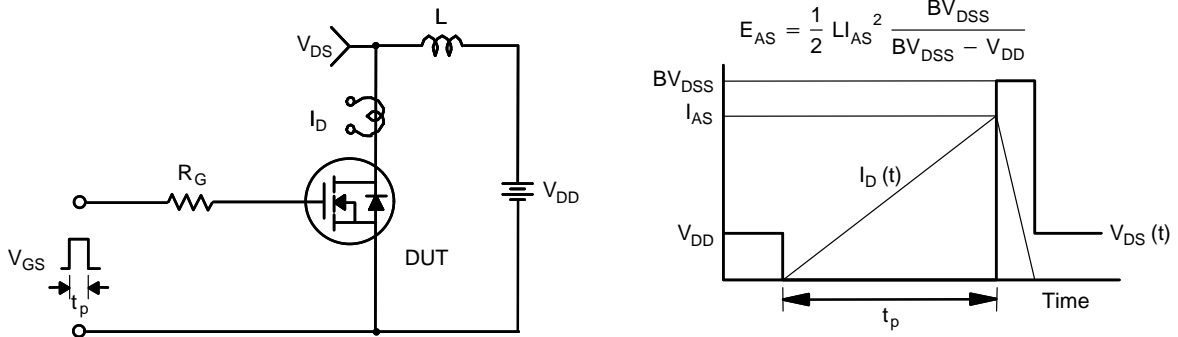

Figure 14. Unclamped Inductive Switching Test Circuit & Waveforms

FCA47N60F

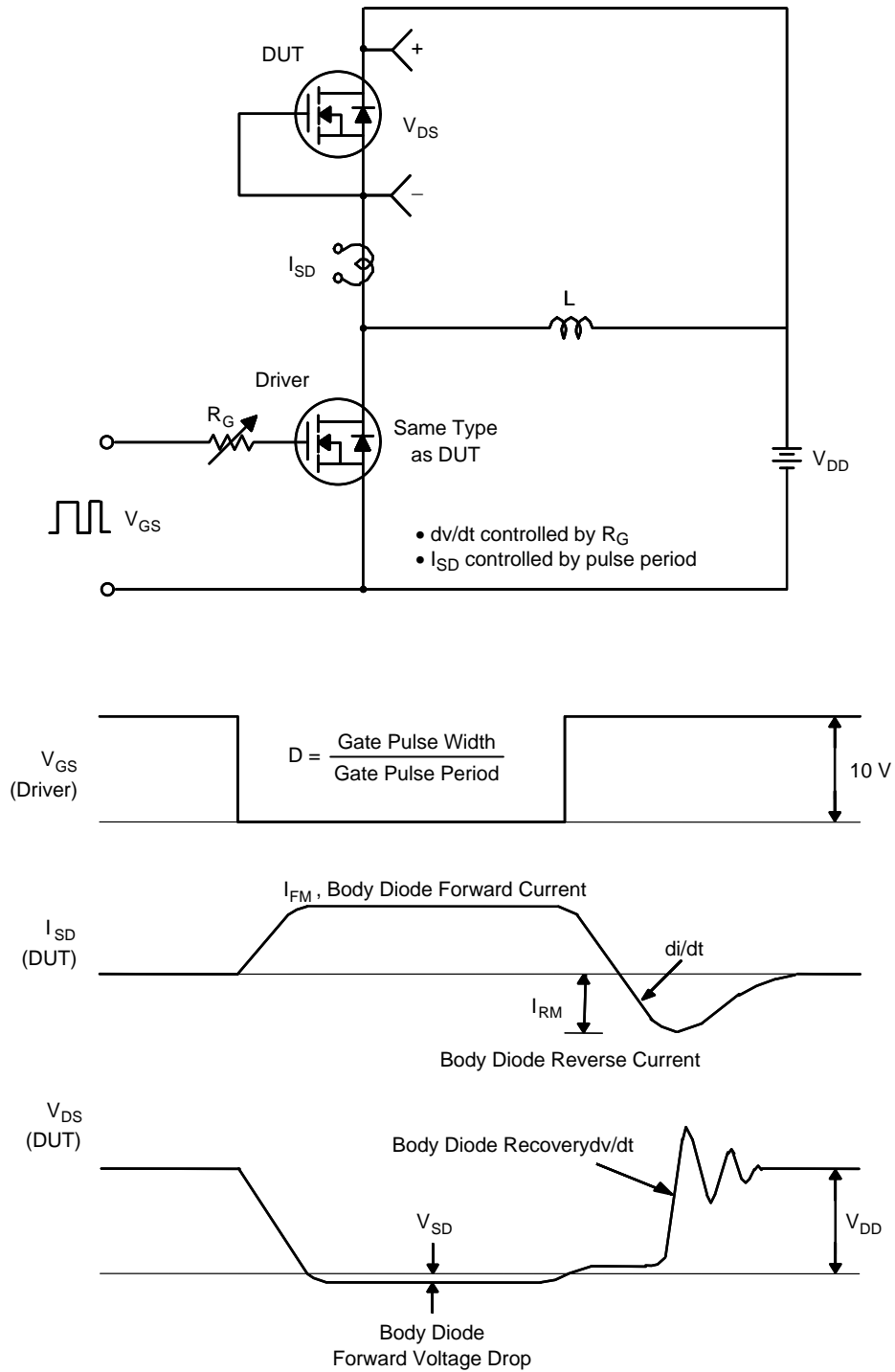
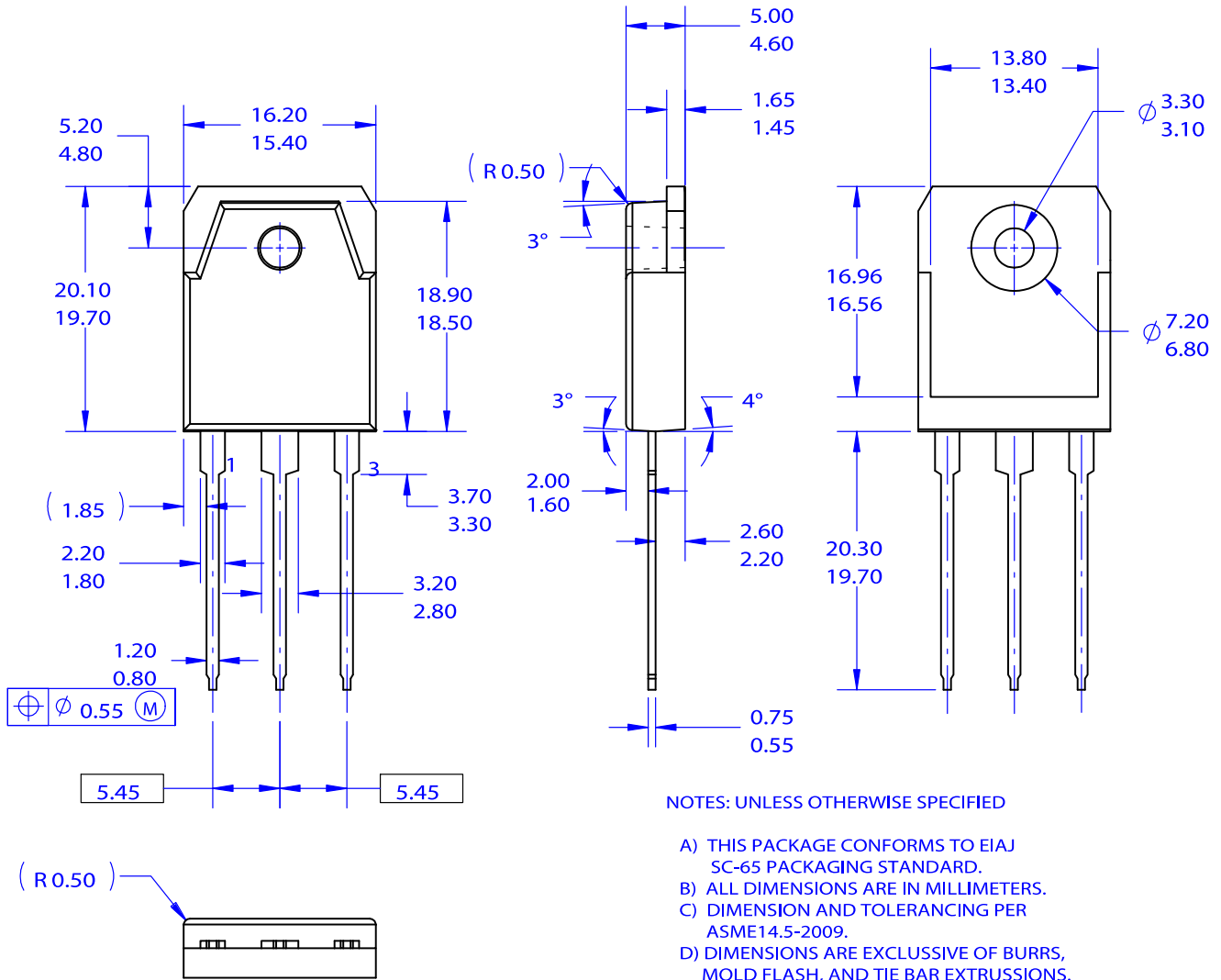

Figure 15. Peak Diode Recovery dv/dt Test Circuit & Waveforms

FRFET and SUPERFET are registered trademarks of Semiconductor Components Industries, LLC dba "onsemi" or its affiliates and/or subsidiaries in the United States and/or other countries.

TO-3P-3LD / EIAJ SC-65, ISOLATED
CASE 340BZ
ISSUE O

DATE 31 OCT 2016



| | | |
|-------------------------|---|--|
| DOCUMENT NUMBER: | 98AON13862G | Electronic versions are uncontrolled except when accessed directly from the Document Repository. Printed versions are uncontrolled except when stamped "CONTROLLED COPY" in red. |
| DESCRIPTION: | TO-3P-3LD / EIAJ SC-65, ISOLATED | PAGE 1 OF 1 |

onsemi and Onsemi are trademarks of Semiconductor Components Industries, LLC dba onsemi or its subsidiaries in the United States and/or other countries. onsemi reserves the right to make changes without further notice to any products herein. onsemi makes no warranty, representation or guarantee regarding the suitability of its products for any particular purpose, nor does onsemi assume any liability arising out of the application or use of any product or circuit, and specifically disclaims any and all liability, including without limitation special, consequential or incidental damages. onsemi does not convey any license under its patent rights nor the rights of others.

onsemi, **Onsemi**, and other names, marks, and brands are registered and/or common law trademarks of Semiconductor Components Industries, LLC dba "**onsemi**" or its affiliates and/or subsidiaries in the United States and/or other countries. **onsemi** owns the rights to a number of patents, trademarks, copyrights, trade secrets, and other intellectual property. A listing of **onsemi**'s product/patent coverage may be accessed at www.onsemi.com/site/pdf/Patent-Marking.pdf. **onsemi** reserves the right to make changes at any time to any products or information herein, without notice. The information herein is provided "as-is" and **onsemi** makes no warranty, representation or guarantee regarding the accuracy of the information, product features, availability, functionality, or suitability of its products for any particular purpose, nor does **onsemi** assume any liability arising out of the application or use of any product or circuit, and specifically disclaims any and all liability, including without limitation special, consequential or incidental damages. Buyer is responsible for its products and applications using **onsemi** products, including compliance with all laws, regulations and safety requirements or standards, regardless of any support or applications information provided by **onsemi**. "Typical" parameters which may be provided in **onsemi** data sheets and/or specifications can and do vary in different applications and actual performance may vary over time. All operating parameters, including "Typicals" must be validated for each customer application by customer's technical experts. **onsemi** does not convey any license under any of its intellectual property rights nor the rights of others. **onsemi** products are not designed, intended, or authorized for use as a critical component in life support systems or any FDA Class 3 medical devices or medical devices with a same or similar classification in a foreign jurisdiction or any devices intended for implantation in the human body. Should Buyer purchase or use **onsemi** products for any such unintended or unauthorized application, Buyer shall indemnify and hold **onsemi** and its officers, employees, subsidiaries, affiliates, and distributors harmless against all claims, costs, damages, and expenses, and reasonable attorney fees arising out of, directly or indirectly, any claim of personal injury or death associated with such unintended or unauthorized use, even if such claim alleges that **onsemi** was negligent regarding the design or manufacture of the part. **onsemi** is an Equal Opportunity/Affirmative Action Employer. This literature is subject to all applicable copyright laws and is not for resale in any manner.

ADDITIONAL INFORMATION

TECHNICAL PUBLICATIONS:

Technical Library: www.onsemi.com/design/resources/technical-documentation
onsemi Website: www.onsemi.com

ONLINE SUPPORT: www.onsemi.com/support

For additional information, please contact your local Sales Representative at www.onsemi.com/support/sales