

NCL30030GEVB



150 W High Performance LED Driver Evaluation Board User's Manual

ON Semiconductor®

www.onsemi.com

EVAL BOARD USER'S MANUAL

Overview

This manual covers the specification, theory of operation, testing and construction of the NCL30030GEVB evaluation board. The NCL30030 board demonstrates a 150 W high performance LED driver intended for commercial/ industrial applications. The NCL30030 combines a CrM PFC boost converter and a QR flyback converter in a single controller. An integrated HV start up is included in the NCL30030.

Table 1. SPECIFICATIONS

Parameter	Value	Comment
Input voltage (Class 2 Input, no ground)	90 – 305 V ac	
Line Frequency	50 Hz / 60 Hz	
Power Factor (Load > 50%)	0.9	
THD (Load > 30%)	20%	Max
Class 1 Output Mains Isolated		
Output Voltage Range	60 – 210 V dc	
“Off” Mode CV Output Voltage	50 V dc	
Output Current	710 mA dc	±2%
Output Ripple	50 mA P-P	
Efficiency	90%	Typical
Start Up Time	< 300 ms	Typical
EMI (conducted)	Class A	FCC/CISPR
Dimensions	55 mm × 220 mm × 33 mm	

Key Features

As illustrated, the key features of this evaluation board include:

- Wide Mains including Support for 277 V ac US Commercial Line Voltage
- Low THD across Line and Load
- High Power Factor across Wide Line and Load
- Remote On/Off (Mains Isolated)
- Integrated Auto-recovery Fault Protection (can be latched by Choice of Options)
 - ◆ On Board Over Temperature Shutdown via NCL30030 Fault Input Pin
 - ◆ LED Module Over Temperature Foldback Input (a remote PTC on LED Array)
 - ◆ Over Voltage
- CC/CV Modes
- Can be Configured for several Dimming Modes
 - ◆ 1 – 10 V dc
 - ◆ 0 – 5 V dc Analog
 - ◆ 0 – 5 V PWM
 - ◆ Bi-level



Figure 1. Evaluation Board Picture (Top View)

THEORY OF OPERATION

PFC

The boost topology is the most common converter type for high performance power factor correction. Since this boost converter operates in CrM, the peak to average input current is always a 2:1 ratio. The converter operates in peak current

control rather than on time control or average current control. CrM boost converters typically have fidelity issues near the zero crossing of the AC line. This is a natural consequence of parasitics in the power stage. See a typical CrM inductor current in Figure 2.

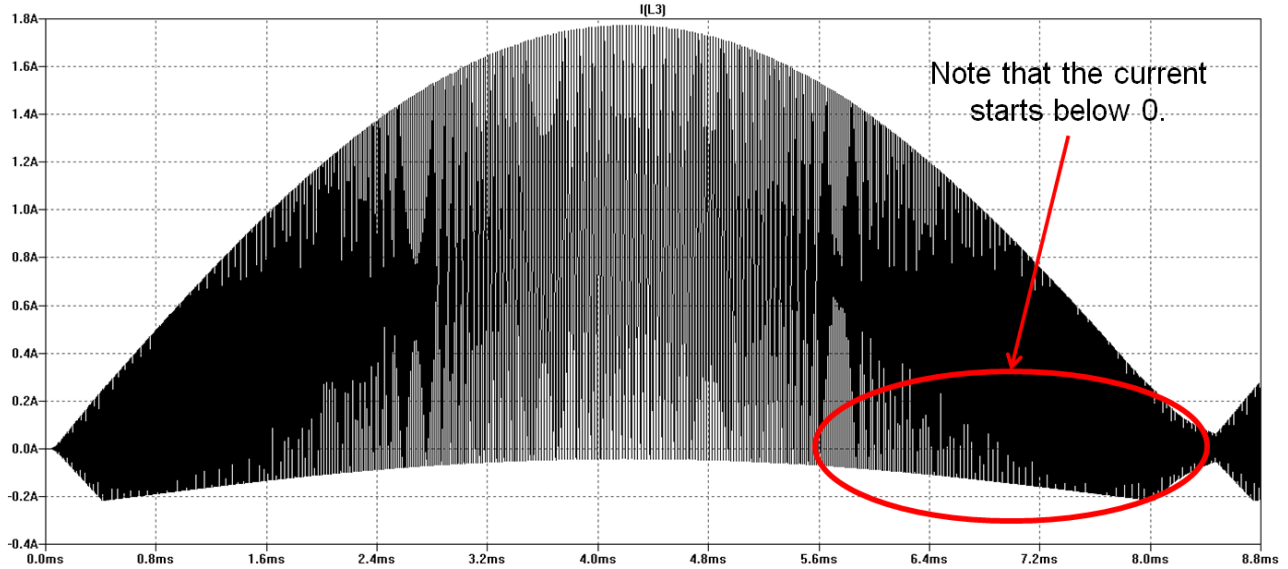

Figure 2. Inductor Current across a Line Cycle

Near the zero crossings, the current starts below zero current. This is a real effect of energy stored in the capacitance of the FET drain that does not get transferred to

the output capacitor. The consequence for on time controllers is that the target peak current is never reached in the on time which results in distortion at the zero crossing.

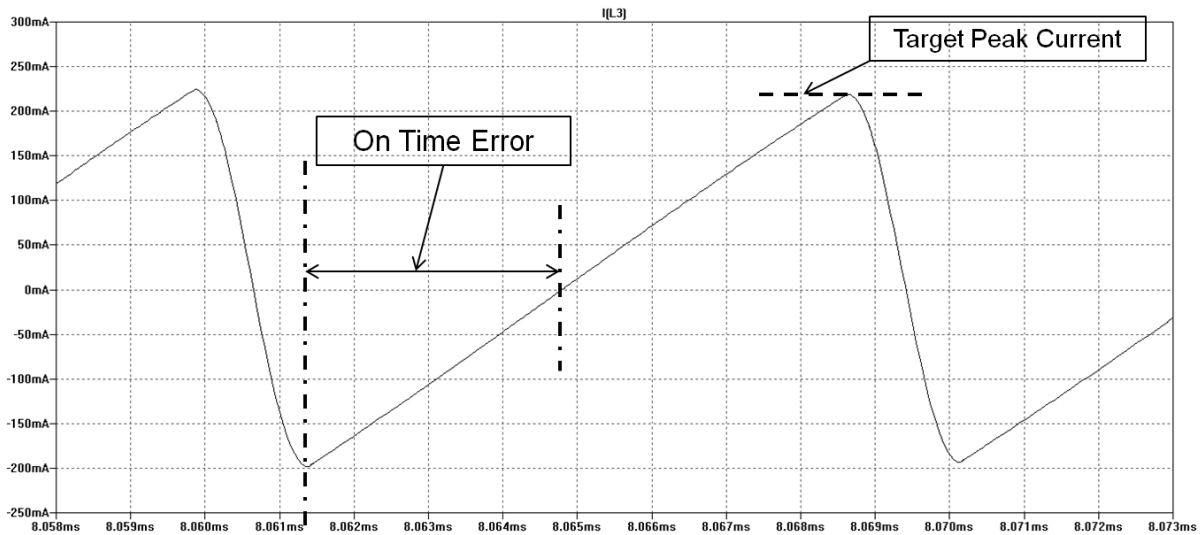

Figure 3. One Switching Cycle of Boost Inductor Current (simulated)

Peak current control corrects the on time error because the on time is dependent on the peak current. This will naturally increase on time at the zero crossing which reduces total harmonic distortion (THD).

multiplier output needs to be filtered to recover the scaled current threshold signal. The value of the filter capacitor is critical to obtain good THD over the entire line range. The filter capacitor must be large enough to filter the PWM carrier frequency but not so large as to cause excess phase lag which will degrade the THD.

The error amplifier adjusts the gain of a PWM multiplier to set the peak current threshold in the controller. The

Bi-Level Boost Follower

The HV pin provides start up current for the controller and sense the HVDC voltage. The boost output reference for the control loop is adjusted based on the input voltage. There are 3 options for this: 2:1, 1.77:1, and 1:1 (i.e. fixed output voltage). This allows the boost converter to operate most efficiently over a broad range of input voltages.

Current Sense and ZCD

The current sense and ZCD are combined on one pin as illustrated in Figure 5. During the switch on time, the peak current is sensed through R24. D11 blocks the negative voltage from the sense winding from affecting the current sense. During the off time, D11 forward biases and pull the pin high through R26. Collapsing voltage on the boost inductor signals that the current has gone to zero and starts a new switch cycle.

Flyback

The flyback converter isolates the output from the mains and provides power for the secondary side control. For this specific design given the high output voltage of the PFC Bus rail and the high voltage range of the output, a two switch flyback configuration was selected. The two switch operation for the flyback optimizes efficiency because the leakage energy is recycled back to the primary energy storage. One limitation of the two switch flyback is that the reflected output voltage must be less than the input voltage otherwise all of the stored energy in the transformer will be returned to the input energy storage. Since the turns ratio is 1:1 and the maximum output voltage is 210 V, that condition is satisfied.

The converter operates in quasi-resonant mode. At heavy loads, the turn on edge is timed to the first valley like CrM mode. At progressively lighter loads, the controller moves the turn on edge to progressively higher order valleys. The voltage on the control determines the valley of operation. There are several important benefits of this technique.

1. The frequency is more stable over the load range
2. The peak current remains higher across load as the switching frequency is reduced. This keeps the signal-to-noise ratio high on the CS pin.

Feedback Control

The NCL30030 has no internal error amplifier for the flyback control. The feedback pin directly programs the peak current and sets the valley selection. There is a current source that pulls up the FB pin. Consequently, the control is setup for secondary side feedback only.

Connections to the Evaluation Board

There are several connections necessary to operate the evaluation board.

- AC Input – J1 3 Pin Connector
 1. AC Line
 2. nc
 3. AC Neutral
- LED Output – J2 3 Pin Connector
 1. LED +
 2. nc
 3. LED–
- Control – J3 7 Pin Connector
 1. 10 V
 2. 1–10 V Dimming
 3. 0–5 V Analog or Digital PWM Dimming
 4. Lamp TCO
 5. Bi-level Dimming
 6. On–Off
 7. Common

Control Connections

10V

This connection provides a current limited 10 V source which can be used to power the dimming interface. Current is limited to 10 mA through a 1 k Ω resistor.

LED Lamp TCO

The LED assembly may have a PTC that “opens” when the LED assembly exceeds a safe temperature. The cold value of the PTC should be approximately 470 Ω and the transition resistance should be greater than 5 k Ω . The action of the TCO folds back the output current to maintain the temperature at a safe level but does not turn the LEDs completely off.

NOTE: Connect the Lamp TCO connection to common if a TCO is not used.

On–Off

The driver can be turned “off” from the secondary side. An open on the on–off connection defaults to “off”. Connect the on–off connection to common to turn on the driver. Off mode operates the output in a low voltage (50 V) CV mode such that the output voltage is below the LED operational voltage.

Dimming Control Mode Setup

The evaluation board can be configured to support numerous dimming configurations; only one type of dimming is supported at a time. In addition to a 1–10 V Dimming interface, analog, digital and bi-level options are supported. Bi-level can be used in conjunction with motion sensors or timers to provide two light output levels depending on the use case.

Table 2. CONFIGURING THE BOARD FOR DIMMING CONTROL

Connection	Mode			
	1 – 10 V	0 – 5 V Analog	0 – 5 V Digital	Bi-Level
1 – 10 V	1 – 10 V Analog Voltage	Open		Open
0 – 5 V Analog	Open	0 – 5 Analog Voltage	N/A	Open
0 – 5 V Digital		N/A	0 – 5 V Digital Input Freq > 400 Hz	Open
Bi-level	Open	Open		Open = High Current GND = Low Current

Modifications

It is possible for the user to select different operating conditions for the evaluation board such as output current, over voltage threshold, and over temperature threshold.

Output Current

R9 and R44 set the output current. R44 is a trim resistor to make fine adjustments to the current set point. The reference voltage for U2 is 62.5 mV. I_{output} is calculated as follows:

$$I_{output} = \frac{62.5 \text{ mV} \times (R9 + R44)}{R9 \times R44}$$

The low reference voltage makes even the copper PCB trace resistance important in setting the output current. There are limitations to setting the current without making major component changes. Generally the current can be adjusted from 0.5 A – 1.0 A.

CV Regulation

As illustrated in Figure 7, the NCP4328A (U2) also serves as the CV regulator loop control. R12, R13, R14, and R28 set the CV output. As built, the evaluation board CV point is 210 V dc. The reference voltage for the CV loop is 1.25 V. R13 and R28 are in parallel. Their equivalent resistance is:

$$R_{eq} = \frac{R13 \times R28}{R13 + R28}$$

CV regulation is calculated as follows:

$$CV = \frac{R13 + R_{eq} + R14}{R_{eq}} \times 1.25 \text{ V}$$

Over Voltage Protection

Zener D19 is used to set the primary side over voltage fault protection level. As built, the CV loop will prevent an OV fault under normal circumstances. D19 pulls up the fault pin on U1 to trigger a fault. The fault shuts down U1 for 4 seconds and then recycles the fault latch. A non-resetting latch is an option for U1. The set point for the trip point is calculated as follows:

$$OV = \frac{V_{d19}}{30\%}$$

D19 must be replaced to change the OV threshold.

Thermal Protection

The evaluation board has an onboard thermal shutdown utilizing the NTC R3 connected to the fault pin of U1. As R3 heats, the output current will shut off until the NTC cools down. R3 can be replaced with a fixed resistor if no thermal protection is desired.

NCL30030GEVB

SCHEMATIC

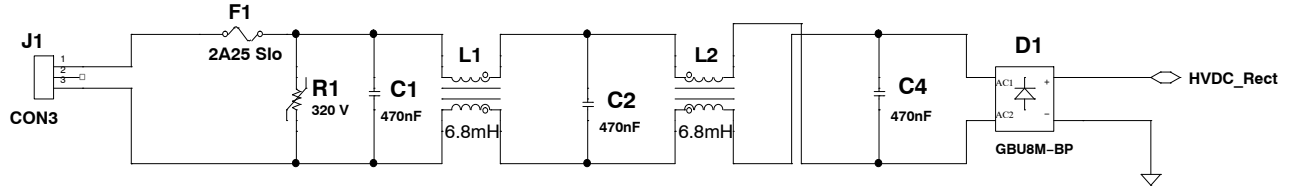

Figure 4. Input Circuit

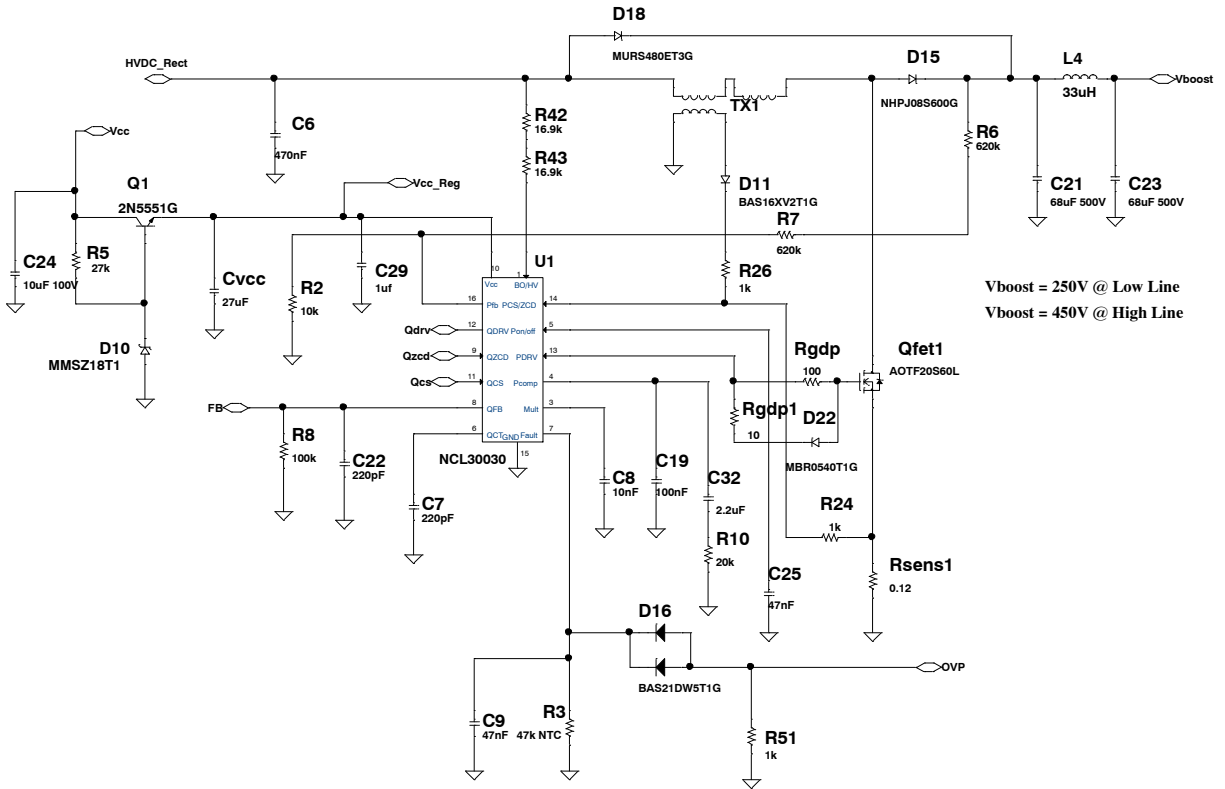

Figure 5. PFC Schematic

NCL30030GEVB

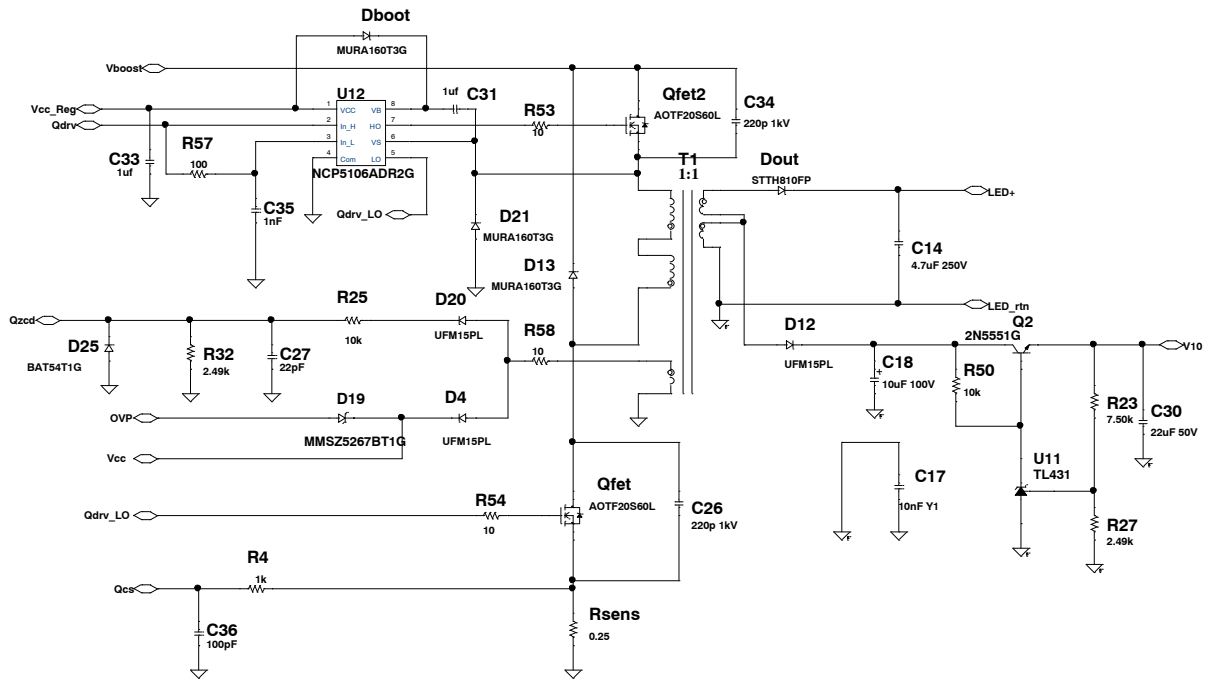

Figure 6. Flyback Schematic

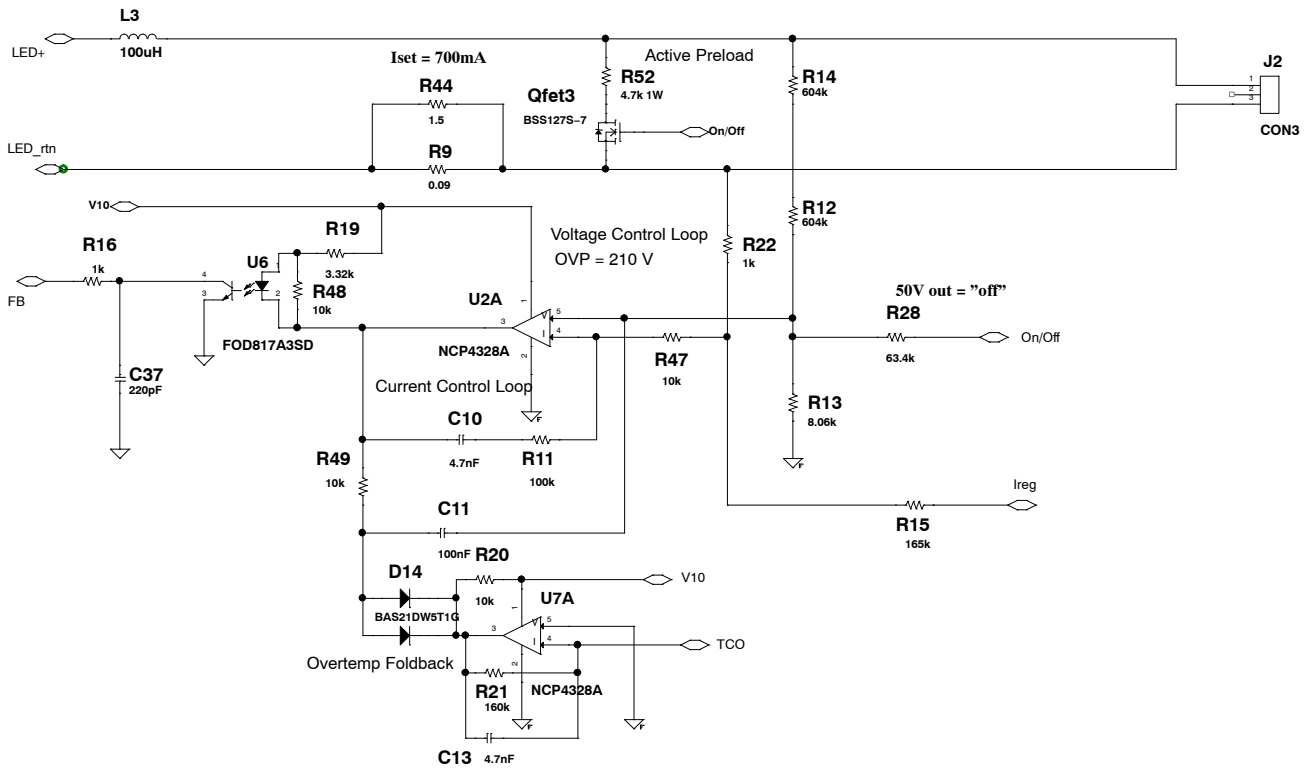

Figure 7. Control Schematic

NCL30030GEVB

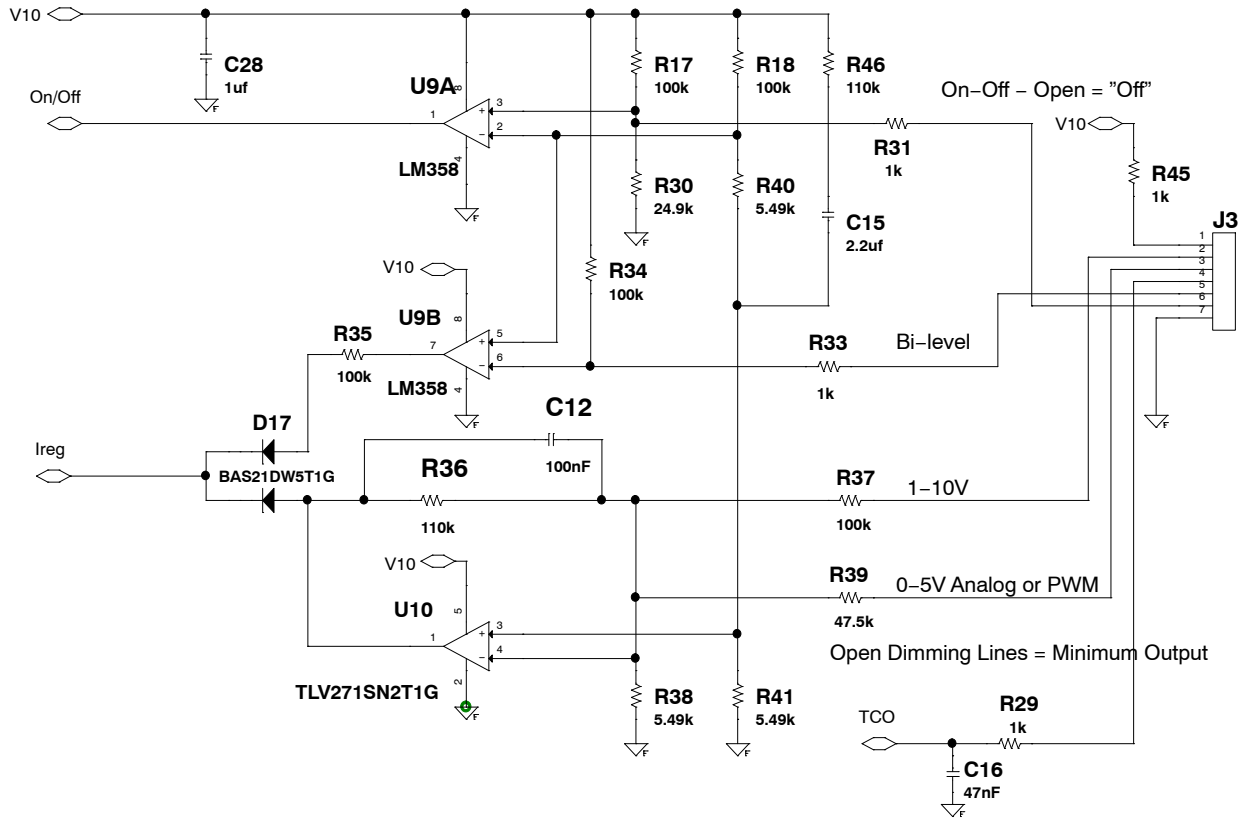

Figure 8. Dimming Interface

BILL OF MATERIAL

Table 3. BILL OF MATERIAL*

Qty	Reference	Part	Manufacturer	Mfr_PN	PCB Footprint	Substitutions Allowed
1	Cvcc	27uF	Panasonic	EEU-FC1E270	CAP_AL_5X11	Yes
4	C1,C2,C4, C6	470nF	Epcos	B32923C3474K	CAP-BOX-LS22M5-26MX7M	Yes
3	C7,C22, C37	220pF	Yageo	CC0805JRNPO9BN221	805	Yes
1	C8	10nF	AVX	0805YA103JAT2A	805	Yes
3	C9,C16, C25	47nF	Yageo	CC0805KRX7R9BB473	805	Yes
2	C10,C13	4.7nF	Yageo	CC0805KRX7R9BB472	805	Yes
3	C11,C12, C19	100nF	Yageo	CC0805KRX7R9BB104	805	Yes
1	C14	4.7uF 250V	Panasonic	ECQ-E2475KB	CAP-BOX-LS175-8M5X18	Yes
1	C15	2.2uf	Taiyo Yuden	UMK212BB7225KG-T	805	Yes
1	C17	10nF Y1	Vishay	440LS10-R	Cap_disc_20mm	Yes
2	C18,C24	10uF 100V	Rubycon	100PK10MEFC5X11	CAP_AL_5X11	Yes
1	C21	68uF 500V	Nichicon	UCY2H680MHD	CAP-ALEL-18X42-HOR-REV	Yes
1	C23	68uF 500V	Nichicon	UCY2H680MHD	CAP-ALEL-18X42-HOR	Yes
2	C26,C34	220p 1kV	Kemet	R76QD0220SE00J	CAP-BOX-LS5-3M5X7M2	Yes
1	C27	22pF	Yageo	CC0805JRNPO9BN220	805	Yes
4	C28,C29, C31,C33	1uF	Yageo	CC0805KKX7R8BB105	805	Yes
1	C30	22uF 50V	Rubycon	50YXM22MEFC5X11	CAP_AL_5X11	Yes
1	C32	2.2uF	Yageo	CC0805KKX7R6BB225	805	Yes

*All Components to be RoHS Compliant

NCL30030GEVB

Table 3. BILL OF MATERIAL*

Qty	Reference	Part	Manufacturer	Mfr_PN	PCB Footprint	Substitutions Allowed
1	C35	1nF	Yageo	CC0805JRNPO9BN102	805	Yes
1	C36	100pF	Yageo	CC0805JRNPO9BN101	805	Yes
3	D13,D21, Dboot	MURA160T3G	ON Semiconductor	MURA160T3G	SMA	No
1	Dout	STTH810FP	ST	STTH810FP	TO-220-2_vert	Yes
1	D1	GBU8M-BP	MCC	GBU8M-BP	4P_inline	Yes
3	D4,D12, D20	UFM15PL	MCC	UFM15PL	SOD123FL	Yes
1	D10	MMSZ18T1	ON Semiconductor	MMSZ18T1	SOD123FL	No
1	D11	BAS16XV2T1G	ON Semiconductor	BAS16XV2T1G	SOD523	No
3	D14,D16, D17	BAS21DW5T1G	ON Semiconductor	BAS21DW5T1G	SC-88A	No
1	D15	NHPJ08S600G	ON Semiconductor	NHPJ08S600G	TO-220-UP	No
1	D18	MURS480ET3G	ON Semiconductor	MURS480ET3G	SMC	No
1	D19	MMSZ5267BT1G	ON Semiconductor	MMSZ5267BT1G	SOD123FL	No
1	D22	MBR0540T1G	ON Semiconductor	MBR0540T1G	SOD123FL	No
1	D25	BAT54T1G	ON Semiconductor	BAT54T1G	SOD123FL	No
1	F1	2A25 Slo	Littelfuse	02092.25MXEP	15mm_axial	Yes
2	J1,J2	CON3	Würth	6.91E+11	Conn_3P_Scrmnt	Yes
1	J3	CON7	On Shore	OSTTA074163	Conn_7P_Scrmnt	Yes
2	L1,L2	6.8mH	Würth	7.5E+08	HOR-4P-19X10	Yes
1	L3	100uH	Würth	7.45E+08	Rad_Ind_LS5	Yes
1	L4	33uH	Würth	7.45E+08	Rad_Ind_LS5	Yes
3	Qfet1,Qfet2, Qfet	AOTF20S60L	AOS	AOTF20S60L	TO-220-3-Vert	Yes
1	Qfet3	BSS127S-7	Diodes	BSS127S-7	SOT23	Yes
2	Q1,Q2	2N5551G	ON Semiconductor	2N5551G	TO92	No
2	R57,Rgdp	100	Yaego	RC0805FR-07100RL	805	Yes
4	Rgdp1,R53, R54,R58	10	Yaego	RC0805FR-0710RL	805	Yes
1	Rsens	0.25	Vishay	WSL2512R2500FEA	2512	Yes
1	Rsens1	0.12	Yaego	RL2512FK-070R12L	2512	Yes
1	R1	320 V	Epcos	S20K320E2	MOV_20mm_disc	Yes
6	R2,R20, R25,R47, R48,R49	10k	Yaego	RC0805FR-0710KL	805	Yes
1	R3	47k NTC	Epcos	B57431V2473J62	805	Yes
10	R4,R16,R22,R24, R26,R29, R31,R33, R45,R51	1k	Yaego	RC0805FR-071KL	805	Yes
1	R5	27k	Yaego	RC0805FR-0727KL	805	Yes
2	R6,R7	620k	Yageo	RC1206FR-07620KL	1206	Yes
7	R8,R11, R17,R18, R34,R35, R37	100k	Yaego	RC0805FR-07100KL	805	Yes
1	R9	0.09	Vishay	WSL1206R0900FEA	1206	Yes
1	R10	20k	Yaego	RC0805FR-0720KL	805	Yes
2	R12,R14	604k	Yageo	RC1206FR-07604KL	1206	Yes
1	R13	8.06k	Yaego	RC0805FR-078K06L	805	Yes
1	R15	165k	Yaego	RC0805FR-07165KL	805	Yes
1	R19	3.32k	Yaego	RC0805FR-073K32L	805	Yes
1	R21	160k	Yaego	RC0805FR-07160KL	805	Yes
1	R23	7.50k	Yaego	RC0805FR-077K5L	805	Yes
2	R27,R32	2.49k	Yaego	RC0805FR-072K49L	805	Yes

*All Components to be RoHS Compliant

NCL30030GEVB

Table 3. BILL OF MATERIAL*

Qty	Reference	Part	Manufacturer	Mfr_PN	PCB Footprint	Substitutions Allowed
1	R28	63.4k	Yaego	RC0805FR-0763K4L	805	Yes
1	R30	24.9k	Yaego	RC0805FR-0724k9L	805	Yes
2	R36,R46	110k	Yaego	RC0805FR-07110KL	805	Yes
3	R38,R40, R41	5.49k	Yaego	RC0805FR-075K49L	805	Yes
1	R39	47.5k	Yaego	RC0805FR-0747K5L	805	Yes
2	R42,R43	16.9k	Yaego	RC1206FR-0716K9L	1206	Yes
1	R44	1.5	Yaego	RC1206FR-071R5L	1206	Yes
1	R50	10k	Yaego	RC1206FR-0710KL	1206	Yes
1	R52	4.7k 1W	Yaego	RSF100JB-73-4K7	15MM_Axial	Yes
1	TX1	XFRM_LINEAR	Würth	7.5E+08	PQ2625-X12	Yes
1	T1	XFRM_LINEAR	Würth	750314657 Rev3	ER2817	Yes
1	U1	NCL30030	ON Semiconductor	NCL30030B1DR2G	SO16-P2	No
2	U2,U7	NCP4328A	ON Semiconductor	NCP4328A	TSOP-5	No
1	U6	FOD817A3SD	Fairchild	FOD817A3SD	4SMD	Yes
1	U9	LM358	ON Semiconductor	LM358DR2G	SO8M1	No
1	U10	TLV271SN2T1G	ON Semiconductor	TLV271SN2T1G	SOT23-5	No
1	U11	TL431	ON Semiconductor	TL431ACLPRAG	TO92	No
1	U12	NCP5106ADR2G	ON Semiconductor	NCP5106ADR2G	SO8M1	No

*All Components to be RoHS Compliant

NCL30030GEVB

GERBER VIEWS

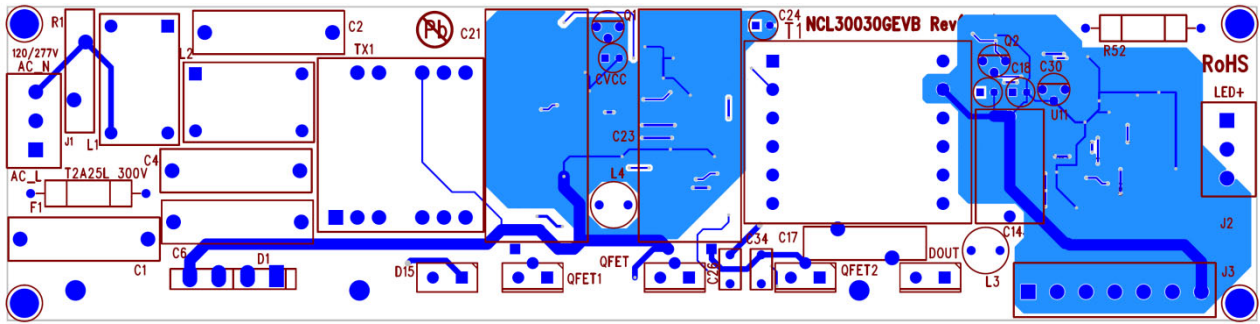

Figure 9. Top Side PCB

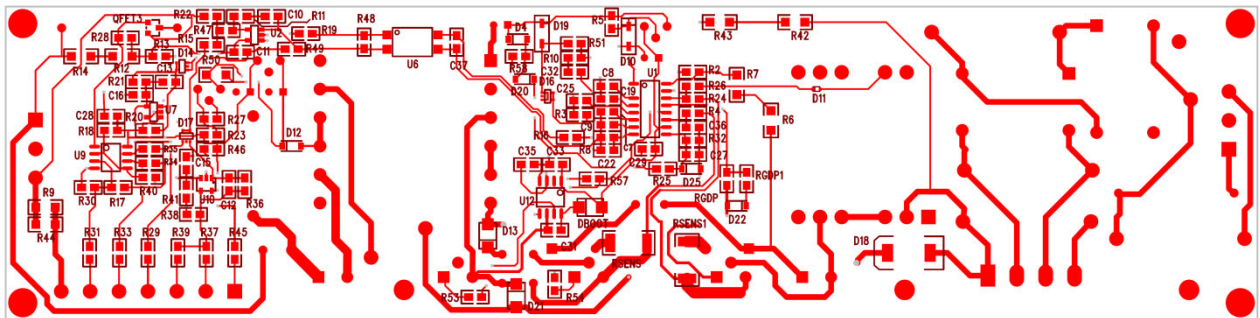

Figure 10. Bottom Side PCB

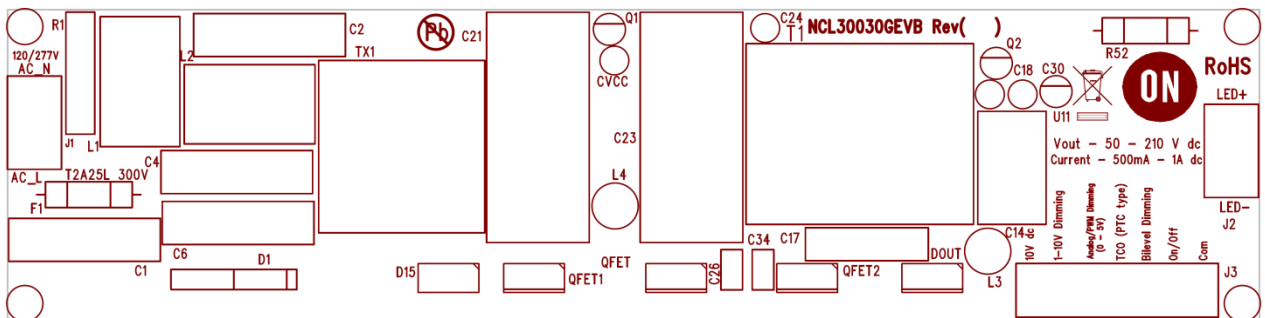

Figure 11. Top Silkscreen

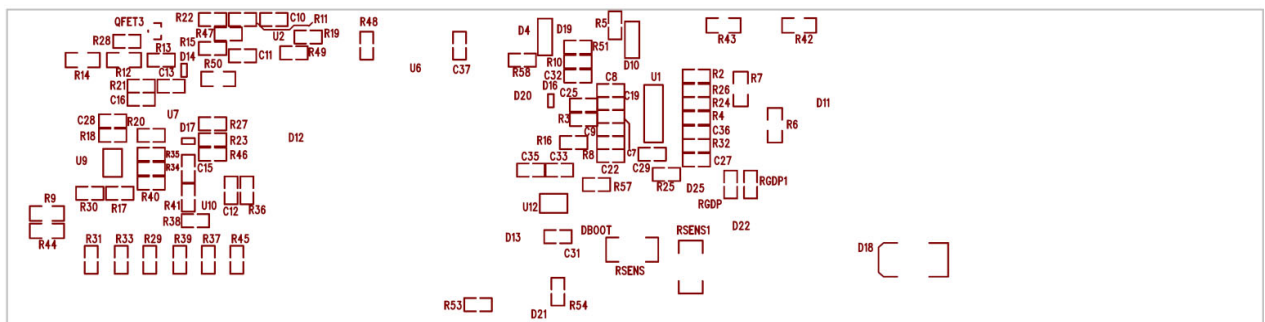



Figure 12. Bottom Silkscreen

CIRCUIT BOARD FABRICATION NOTES

1. Fabricate per IPC-6011 and IPC6012. Inspect to IPA-A-600 Class 2 or updated standard.
2. Printed Circuit Board is defined by files listed in fileset.
3. Modification to copper within the PCB outline is not allowed without permission, except where noted otherwise. The manufacturer may make adjustments to compensate for manufacturing process, but the final PCB is required to reflect the associated gerber file design ± 0.001 in. for etched features within the PCB outline.
4. Material in accordance with IPC-4101/21, FR4, Tg 125°C min.
5. Layer to layer registration shall not exceed ± 0.004 in.
6. External finished copper conductor thickness shall be 0.0026 in. min. (ie 2oz)
7. Copper plating thickness for through holes shall be 0.0013 in. min. (ie 1oz)
8. All holes sizes are finished hole size.
9. Finished PCB thickness 0.062 in.
10. All un-dimensioned holes to be drilled using the NC drill data.
11. Size tolerance of plated holes: ± 0.003 in. : non-plated holes ± 0.002 in.
12. All holes shall be ± 0.003 in. of their true position U.D.S.
13. Construction to be SMOBC, using liquid photo image (LPI) solder mask in accordance with IPC-SM-B40C, Type B, Class 2, and be green in color.
14. Solder mask mis-registration ± 0.004 in. max.
15. Silkscreen shall be permanent non-conductive white ink.
16. The fabrication process shall be UL approved and the PCB shall have a flammability rating of UL94V0 to be marked on the solder side in silkscreen with date, manufactures approved logo, and type designation.
17. Warp and twist of the PCB shall not exceed 0.0075 in. per in.
18. 100% electrical verification required.
19. Surface finish: electroless nickel immersion gold (ENIG)
20. RoHS compliance required.

NCL30030GEVB

FLYBACK TRANSFORMER SPECIFICATION

CUSTOMER TERMINAL	RoHS	LEAD(Pb)-FREE	
Sn96%, Ag4%	Yes	Yes	

PART MUST INSERT FULLY TO SURFACE A IN RECOMMENDED GRID

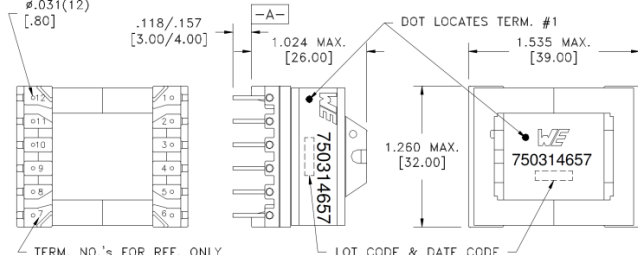

TERM. NO.'s FOR REF. ONLY

LOT CODE & DATE CODE

ALTERNATE MARKING DETAIL

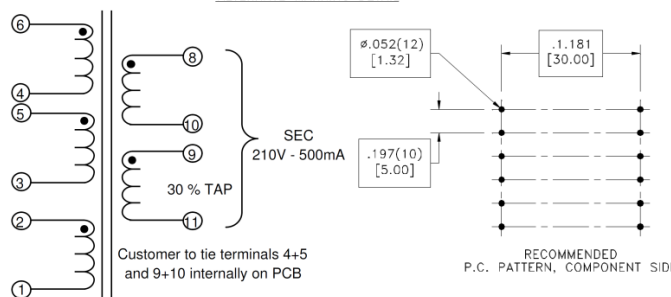

PRI
250-450V
100kHz

AUX

SEC
210V - 500mA

30% TAP

Customer to tie terminals 4+5 and 9+10 internally on PCB

RECOMMENDED P.C. PATTERN, COMPONENT SIDE

ELECTRICAL SPECIFICATIONS @ 25°C unless otherwise noted:

D.C. RESISTANCE (@20°C):

- 1-2, 0.160 Ohms ±10%.
- 3-6 (tie 4+5), 0.170 Ohms ±10%.
- 8-11 (tie 9+10), 0.130 Ohms ±10%.
- 9-11, 0.045 Ohms ±20%.

DIELECTRIC RATING:

- 3000VAC, 1 minute tested by applying 3750VAC for 1 second between pins 1-11(tie 2+3+4, 9+10).
- 500VAC, 1 minute tested by applying 625VAC for 1 second between pins 1-6(tie 4+5).

INDUCTANCE:

- 425 µH ±10%, 10kHz, 100mVAC, 0mADC, 3-6(tie 4+5), Ls.

SATURATION CURRENT:

- 3.3A saturating current that causes 20% rolloff from initial inductance.

LEAKAGE INDUCTANCE:

- 8µH typ, 15µH max, 100kHz, 100mVAC, 3-6(tie 4+5, 8+9+10+11), Ls.

URNS RATIO:

- (6-4):(5-3), (1):(1.00), ±1%.
- (6-3):(2-1), (3.29):(1.00), tie(4+5), ±1%.
- (6-3):(9-11), (3.29):(1.00), tie(4+5), ±1%.
- (6-3):(8-11), (1):(1.00), tie(4+5, 9+10), ±1%.

Designed to comply with the following requirements as defined by IEC60950-1, EN60950-1, UL60950-1/CSA60950-1 and AS/NZS60950.1:

- Reinforced insulation for a primary circuit at a working voltage of 450VDC.



OPERATING TEMPERATURE RANGE: -40°C to 125°C including temp. rise.

Wire insulation & RoHS status not affected by wire color. Wire insulation color may vary depending on availability.

Wurth Electronics Midcom Inc. Watertown, SD USA Toll Free: 800-643-2661 Fax: 605-886-4486	Unless otherwise specified, tolerances are as follows: Angles: ±1° Fractions: ±1/64 Decimals: ±.005(-.127mm) Footprint: ±.001(.03mm)	more than you expect	
	Drawing Title <h3 style="margin: 0;">Transformer</h3>	Drawing Number <h3 style="margin: 0;">750314657</h3>	Rev. <h3 style="margin: 0;">03</h3>
This drawing is dual dimensioned. Dimensions is brackets are in millimeters	Revisions: See Sheet 1	Scale ----	Spec Sheet 1 of 1
Engineer: LJG		05/30/2014	

NCL30030GEVB

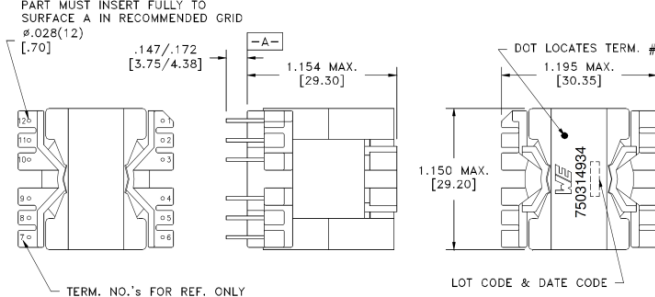
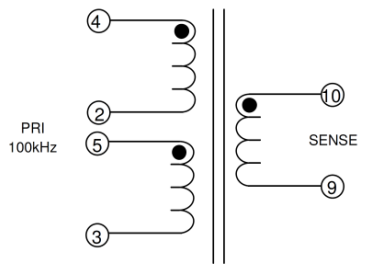
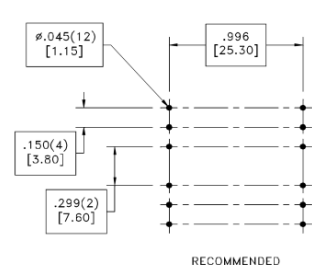
PFC INDUCTOR SPECIFICATION

CUSTOMER TERMINAL Sn96%, Ag4%	RoHS Yes	LEAD(Pb)-FREE Yes	
<p style="font-size: small;">PART MUST INSERT FULLY TO SURFACE A IN RECOMMENDED GRID</p>  <p style="font-size: small;">TERM. NO.'s FOR REF. ONLY</p> <p style="font-size: small;">LOT CODE & DATE CODE</p>			
		 <p style="font-size: x-small; text-align: center;">RECOMMENDED P.C. PATTERN, COMPONENT SIDE</p>	
<p>ELECTRICAL SPECIFICATIONS @ 25°C unless otherwise noted:</p> <p>D.C. RESISTANCE (@20°C): 2-5 (tie 3+4), 0.183 Ohms ±10%. 9-10, 0.026 Ohms ±20%.</p> <p>DIELECTRIC RATING: 500VAC, 1 minute tested by applying 625VAC for 1 second between pins 2-10 (tie3+4).</p> <p>INDUCTANCE: 350µH ±10%, 10kHz, 100mVAC, 0mADC, 2-5(3+4), Ls.</p> <p>SATURATION CURRENT: 8.4A saturating current that causes 20% rolloff from initial inductance.</p> <p>LEAKAGE INDUCTANCE: 35µH max., 100kHz, 100mVAC, 2-5(tie 3+4, 9+10), Ls.</p> <p>TURNS RATIO: (5-3):(4-2), (2.33):(1.00), ±1%. (5-2):(10-9), (15):(1.00), (tie 3+4), ±1%.</p>			
<p>OPERATING TEMPERATURE RANGE: -40°C to 125°C including temp. rise.</p> <p>Wire insulation & RoHS status not affected by wire color. Wire insulation color may vary depending on availability.</p>			
Wurth Electronics Midcom Inc. Watertown, SD USA Toll Free: 800-643-2661 Fax: 605-886-4486	Unless otherwise specified, tolerances are as follows: Angles: ±1° Fractions: ±1/64 Decimals: ±.005(.127mm) Footprint: ±.001(.03mm)		
	Drawing Title <h3 style="margin: 0;">Inductor</h3>		
This drawing is dual dimensioned. Dimensions is brackets are in millimeters		Revisions: See Sheet 1	Scale ---- Spec Sheet 1 of 1
Engineer:LJG			07/17/2014

NCL30030GEVB

ECA PICTURES

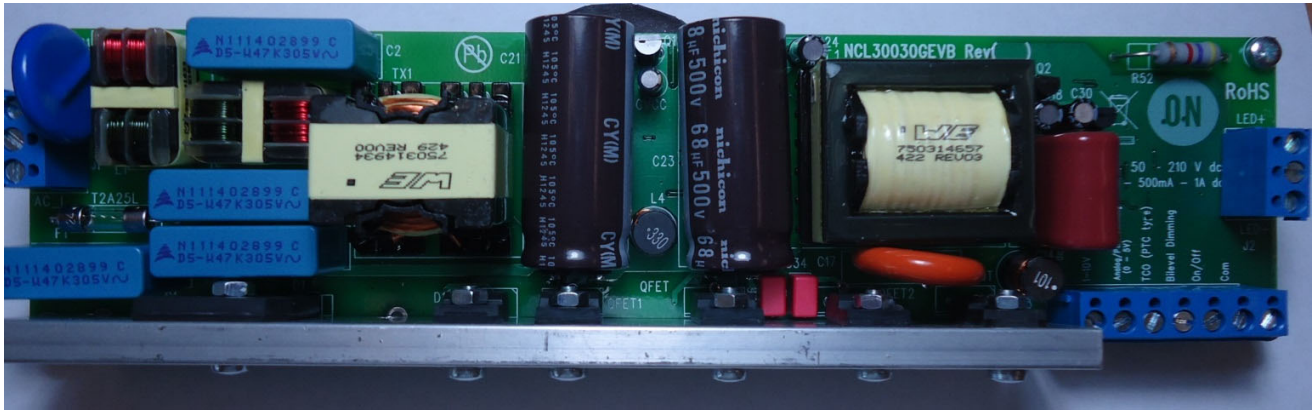

Figure 13. Top View

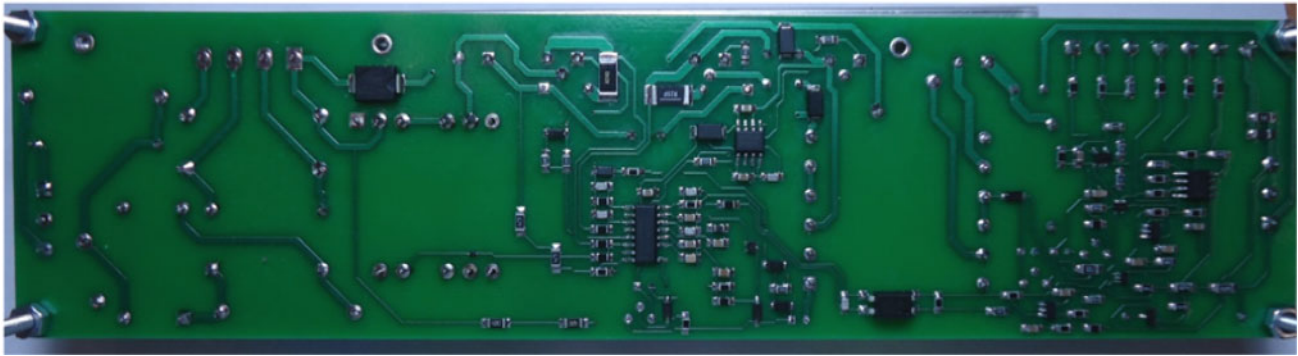

Figure 14. Bottom View

NCL30030GEVB

Material - 6063/61 Al
Break sharp edges

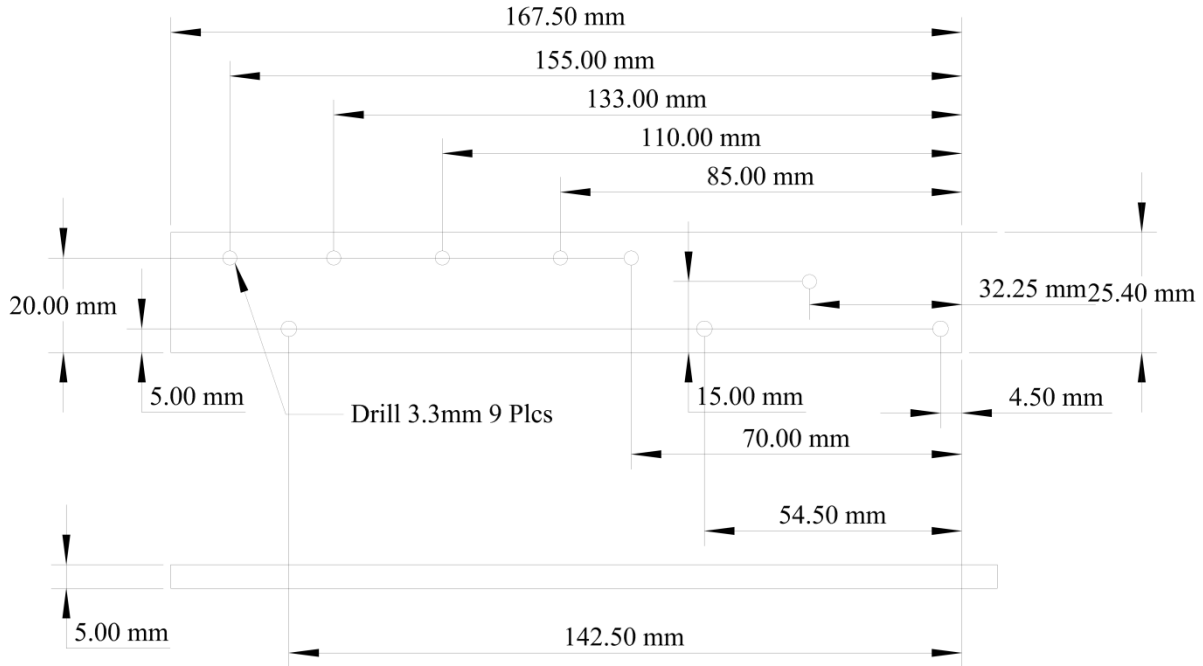

Figure 15. NCL30030 Heatspreader

TEST PROCEDURE

Equipment Needed

- AC Source – 90 to 305 V ac 50/60 Hz Minimum 500 W capability
- AC Wattmeter – 300 W Minimum, True RMS Input Voltage, Current, Power Factor, and THD 0.2% accuracy or better
- DC Voltmeter – 300 V dc minimum 0.1% accuracy or better
- DC Ammeter – 1 A dc minimum 0.1% accuracy or better
- LED Load – 50 V – 210 V @ 1 A

Test Connections

1. Connect the LED Load to J2 through the ammeter shown in Figure 16.

WARNING: Observe the correct polarity or the load may be damaged.

2. Connect the AC power card to J1 and connect the other end to the AC wattmeter shown in Figure 16.
3. Connect a Switch between J3-6 and J3-7. This switch will provide on/off control.
4. Short J3-4 to J3-7. This replaces the external TCO.
5. Connect a 100k Potentiometer to J3 as follows: high side to J3-1, wiper to J3-2, low side to J3-7.
6. Connect the DC voltmeter as shown in Figure 16.

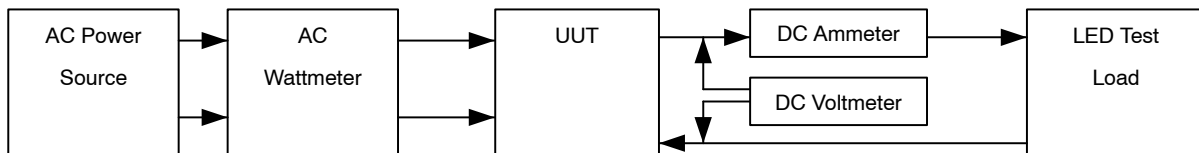

NOTE: Unless otherwise specified, all voltage measurements are taken at the terminals of the UUT.

Figure 16. Test Set Up

NCL30030GEVB

Functional Test Procedure

1. Set the potentiometer to about 50% of its rotation.

NOTE: The on-off switch should be in the open state until instructed otherwise.

2. Set the LED Load for 60 V output.

3. Set the input power to 120 V 60 Hz.

WARNING: Do not touch the ECA once it is energized because there are hazardous voltages present.

4. Close the On/off switch.

LINE AND LOAD REGULATION

Table 4. 120 V / MAX LOAD

Set the potentiometer fully CW (i.e. maximum output)

	Output Current 710 mA ± 14 mA	Output Power	Power Factor	THD < 20%
60 V				
120 V				
210 V				

Table 5. 120 V / MIN LOAD

Set the potentiometer fully CCW (i.e. minimum output)

	Output Current 70 mA Max	Output Power	Power Factor	
60 V				
120 V				
210 V				

Table 6. 277 V / MAX LOAD

Set the potentiometer fully CW (i.e. maximum output)

	Output Current 710 mA ± 14 mA	Output Power	Power Factor	THD < 20%
60 V				
120 V				
210 V				

Table 7. 277 V / MIN LOAD

Set the potentiometer fully CCW (i.e. minimum output)

	Output Current 70 mA Max	Output Power	Power Factor	
60 V				
120 V				
210 V				

$$\text{Efficiency} = \frac{V_{\text{out}} \times I_{\text{out}}}{P_{\text{in}}} \times 100\%$$

NCL30030GEVB

TEST DATA

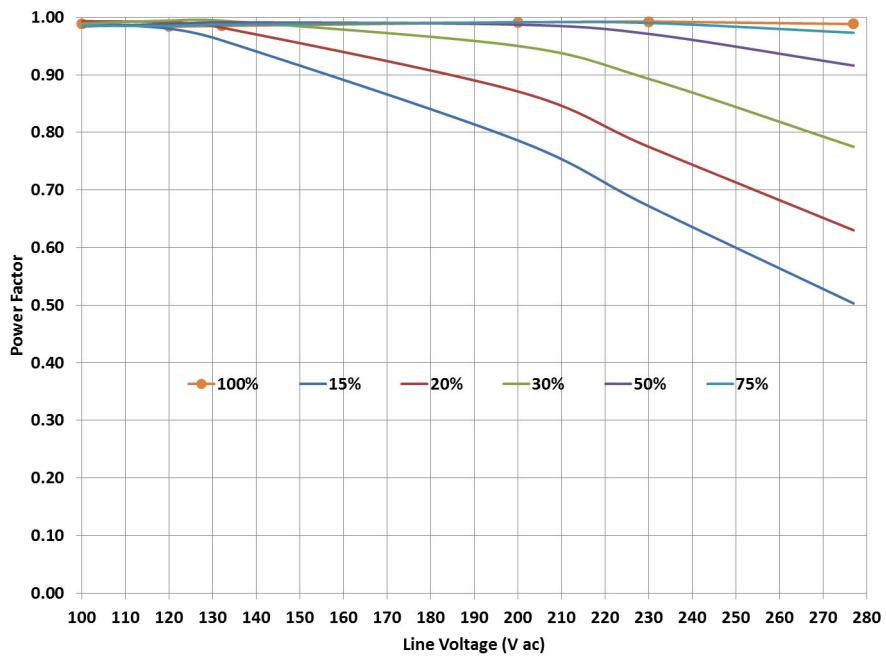

Figure 17. Power Factor over Line and Load

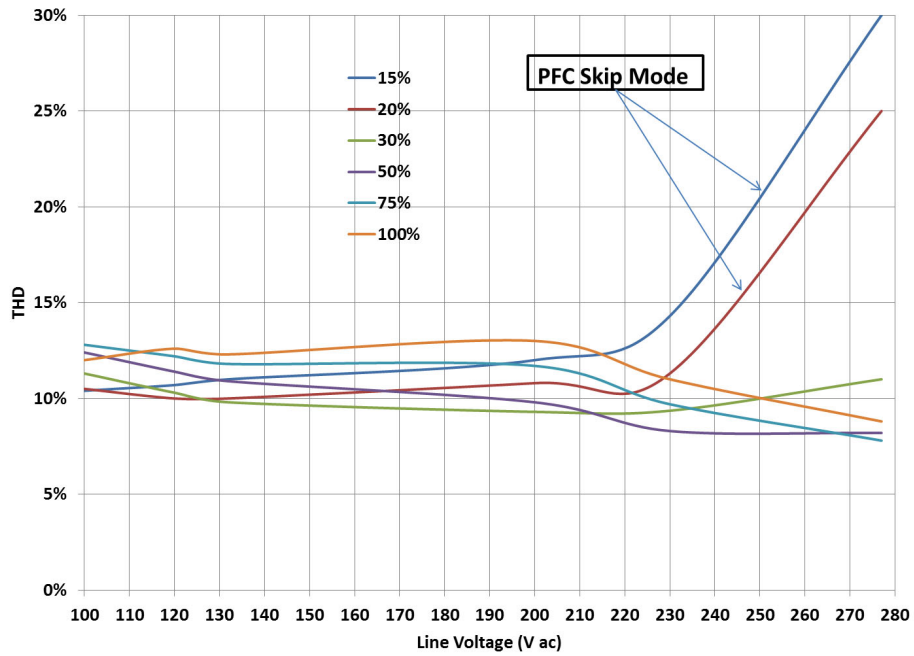

Figure 18. THD over Line and Load

NCL30030GEVB

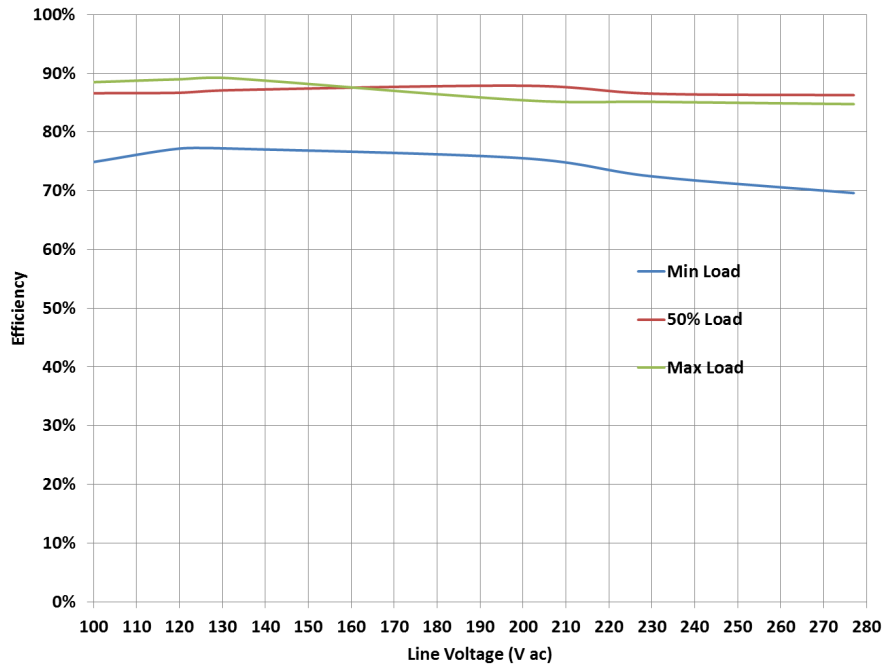

Figure 19. Efficiency over Line and Load @ 60 V dc Output

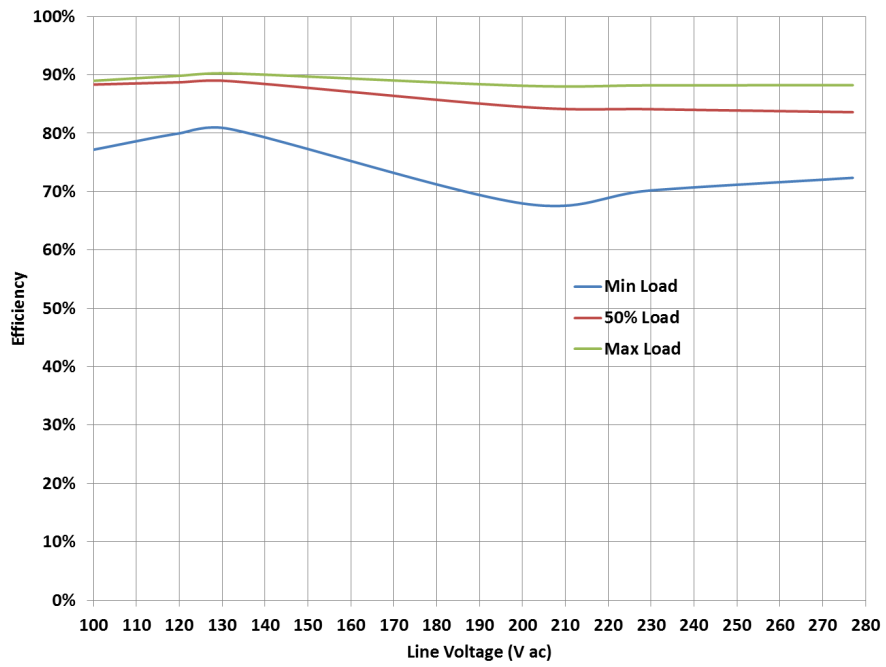

Figure 20. Efficiency over Line and Load @ 120 V dc Output

NCL30030GEVB

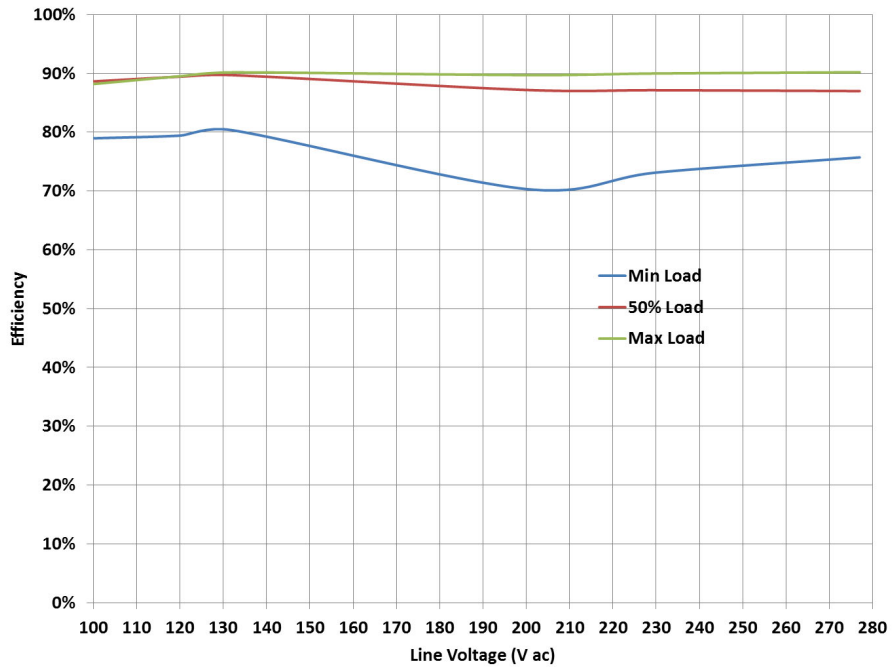

Figure 21. Efficiency over Line and Load @ 210 V dc Output

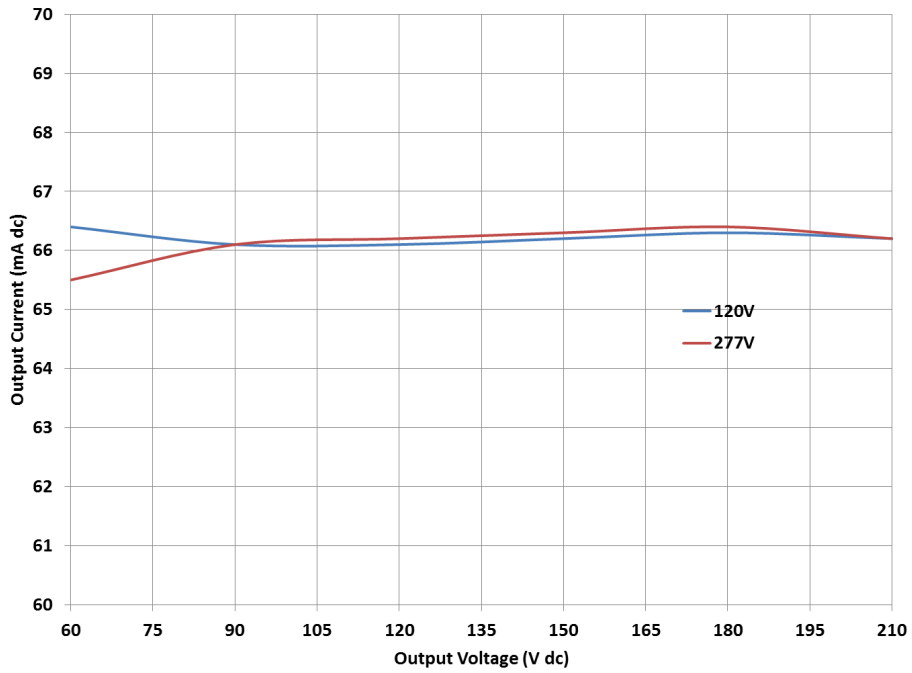

Figure 22. Minimum Load Regulation over Line

NCL30030GEVB

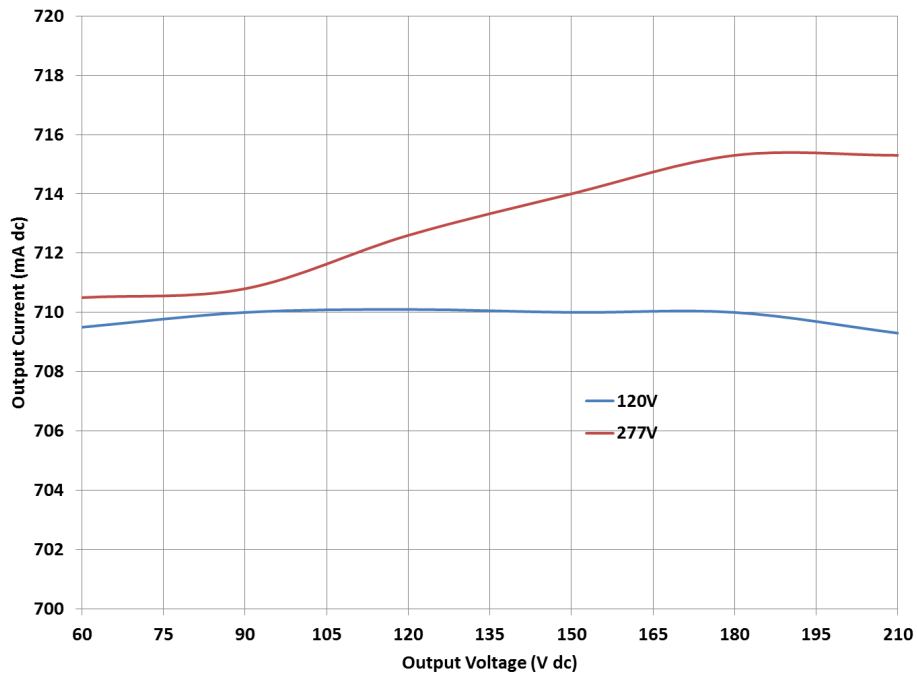

Figure 23. Maximum Load Regulation over Line

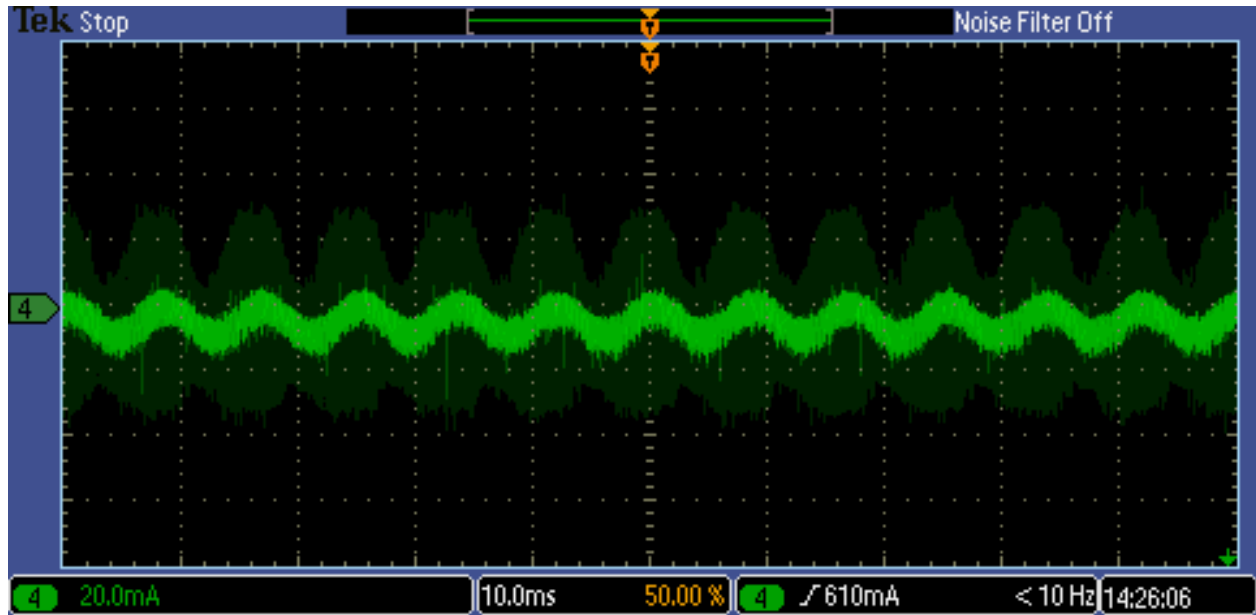

Figure 24. Ripple Current at 120 V ac Maximum Load

NCL30030GEVB

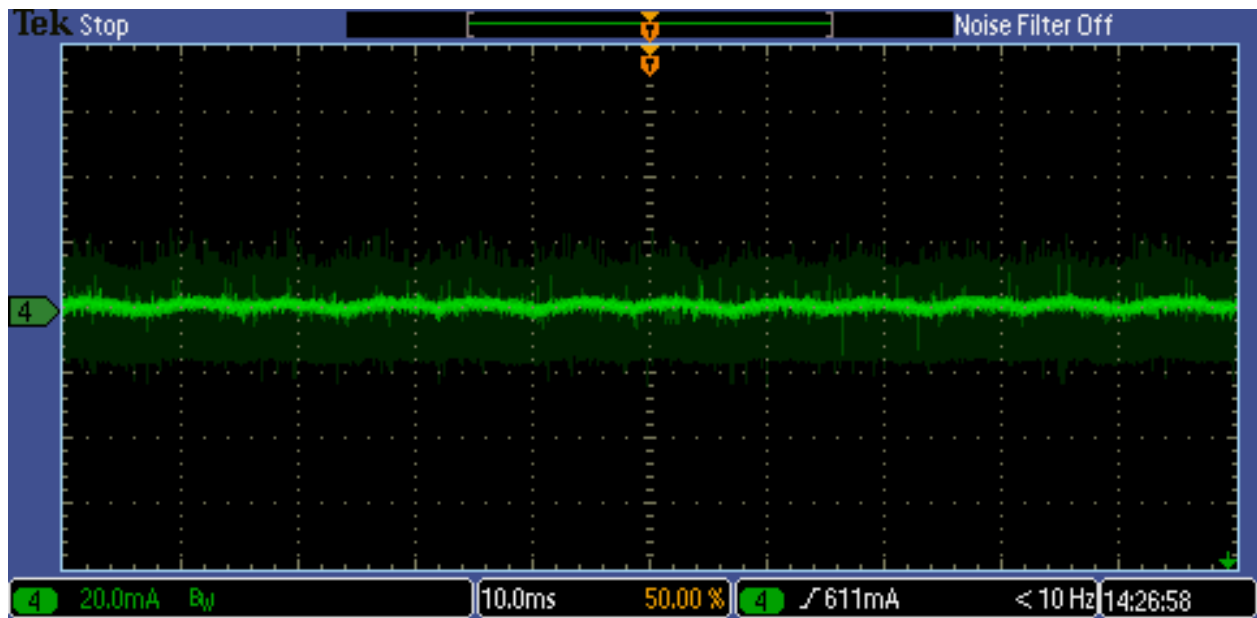

Figure 25. Ripple Current at 277 V ac Maximum Load

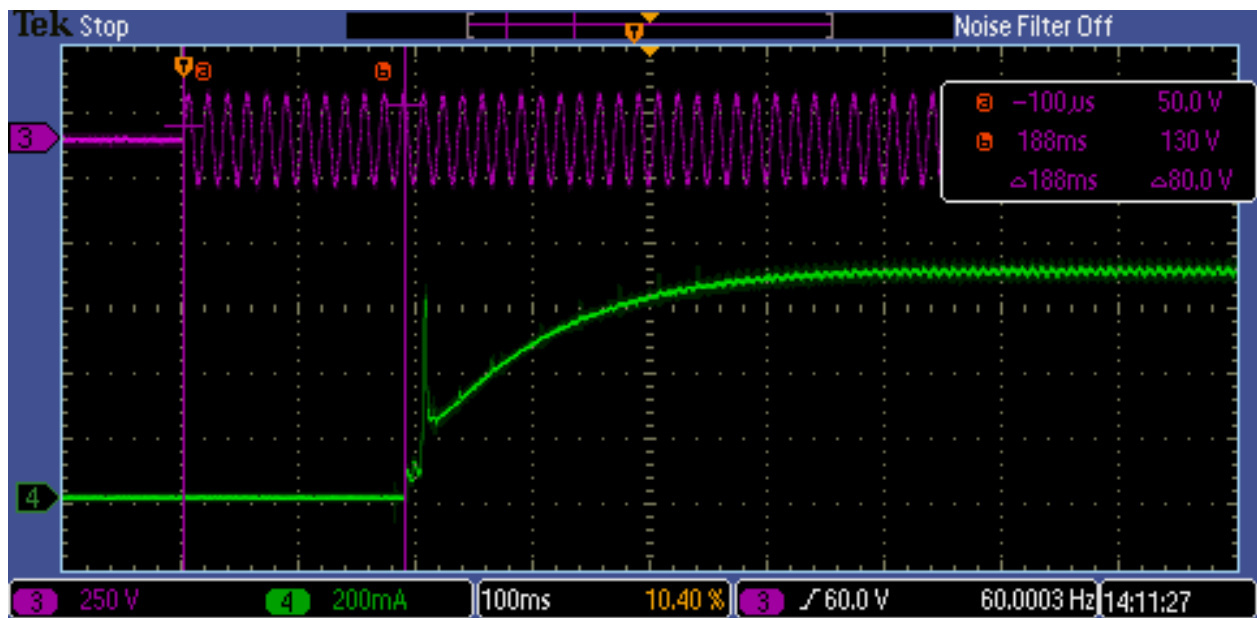

Figure 26. Start Up with AC Applied 120 V Maximum Load

NCL30030GEVB

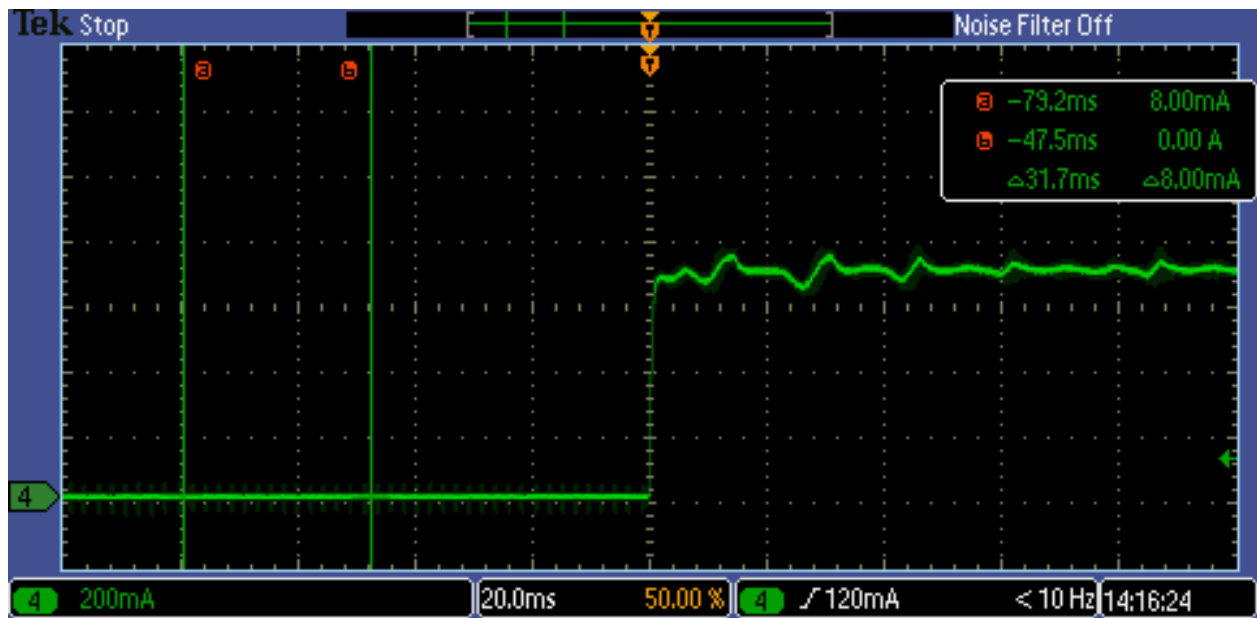

Figure 27. Start Up with On/Off 120 V Maximum Load

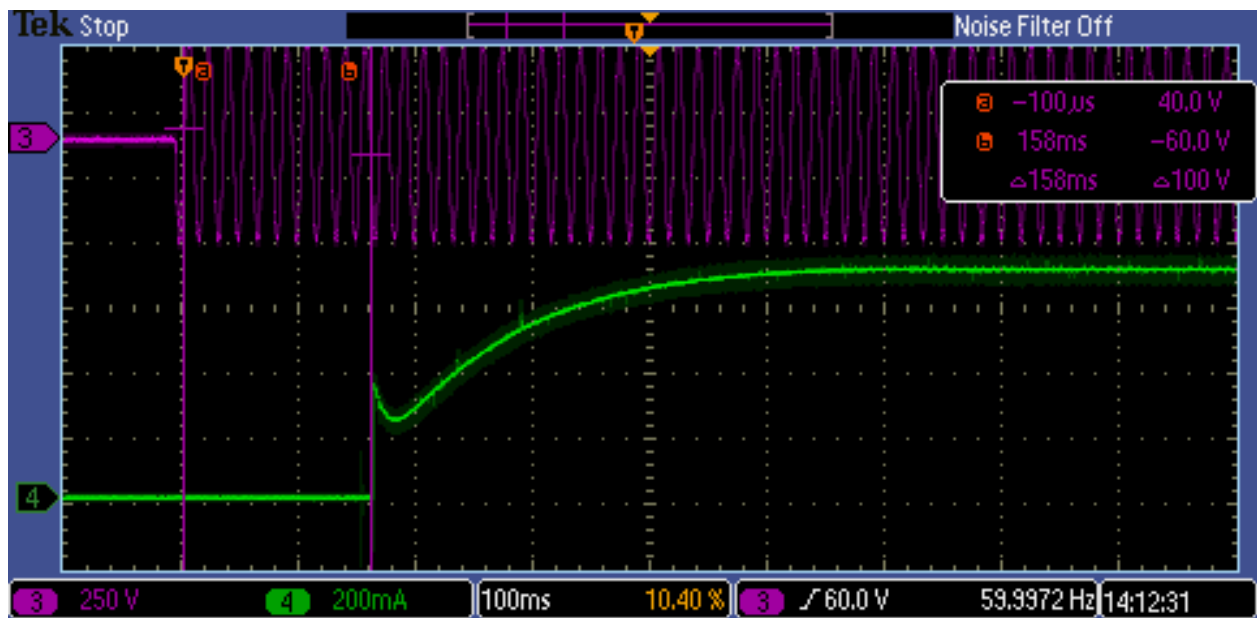

Figure 28. Start Up with AC Applied 277 V Maximum Load

NCL30030GEVB

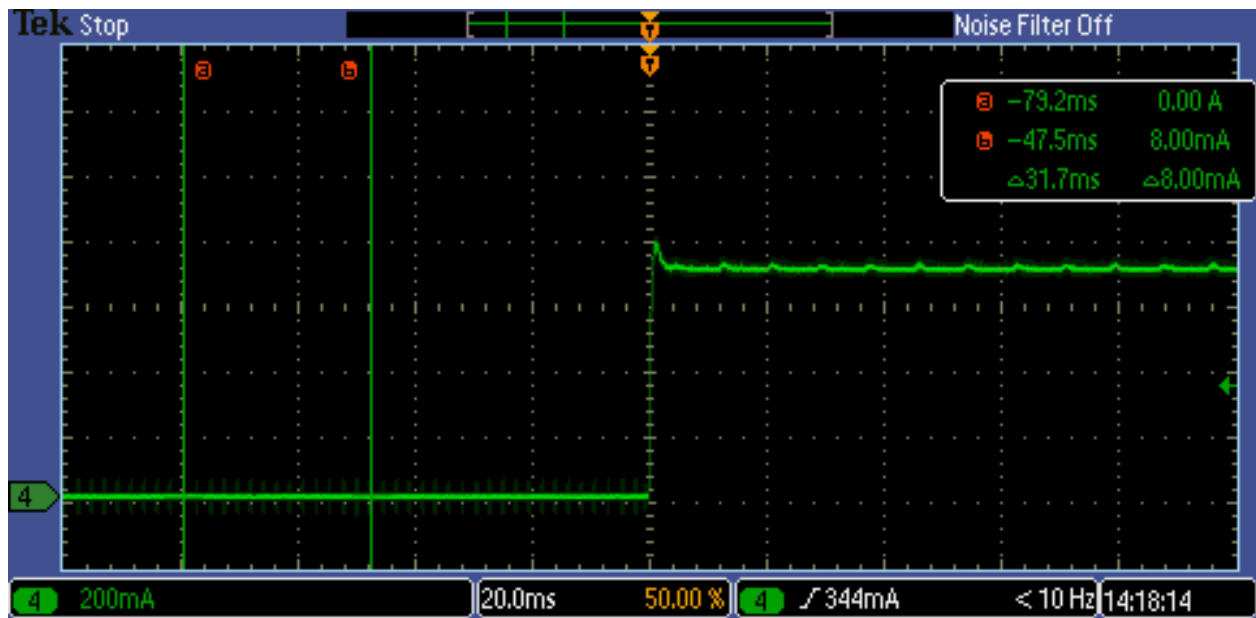

Figure 29. Start Up with AC Applied 277 V Maximum Load

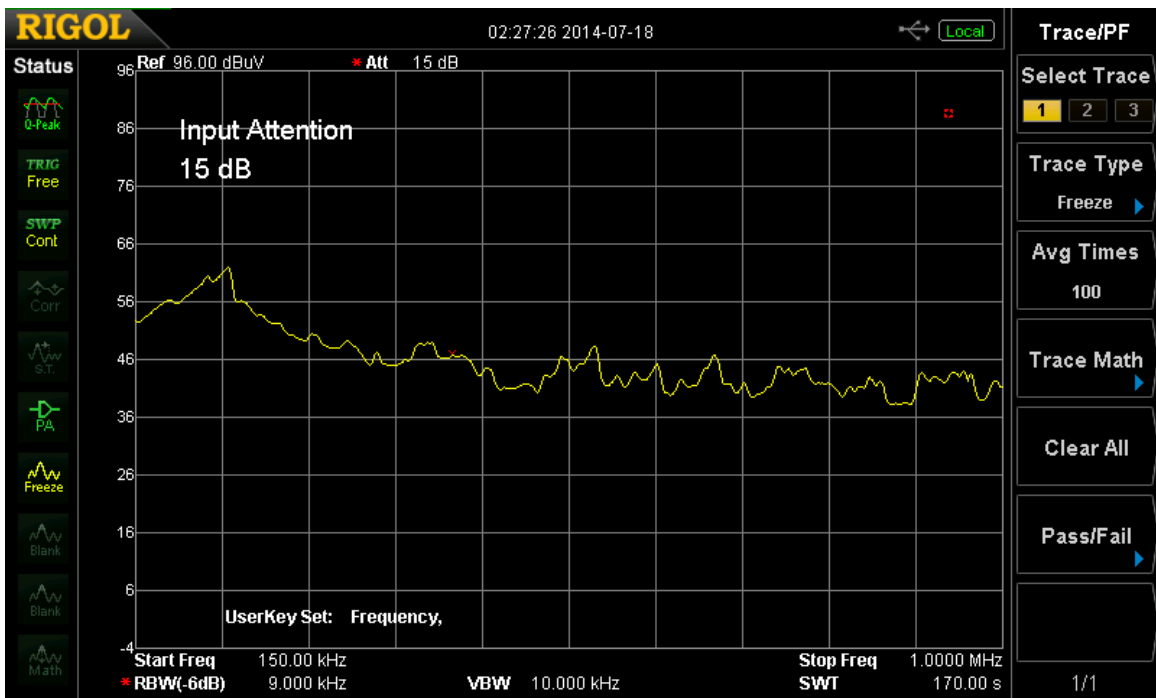

Figure 30. Conducted EMI Pre-compliance QP Data 150 kHz – 1 MHz

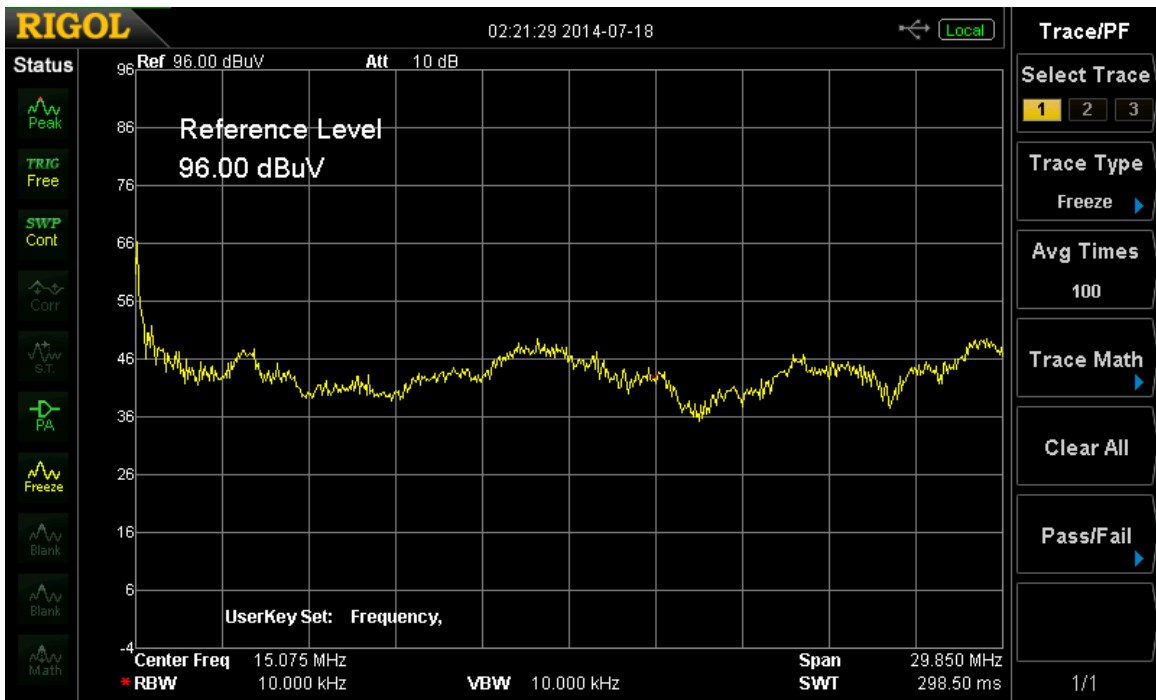

Figure 31. Conducted EMI Pre-compliance Peak Data 150 kHz – 30 MHz

NCL30030GEVB

Product: NCL30030_04		Serial No. N/A		18-Jul-2014 3:27:03PM				
Description: 277Vac 50% Load		Page: 1 of 1						
Voltech Pre-Compliance IEC61000-3-2 Windows Software			Test Date: 18th Jul 2014 15:22:56 PM					
Type of Test: IEC61000-3-2:2005 with Interharmonics to EN61000-4-7:2002			- Worst Case Table					
Power Analyzer: Voltech,PM1000+,100008202290,Ver.4.25			AC Source: Mains / AC Source					
Notes:		Overall Result PASS		Class: Class C,>25W				
				Class Multiplier: 1				
Supply Voltage outside permitted limits. Voltage Crest Factor outside permitted limits.								
<L1 : Reading is below limit 1. <L2 : Reading is below limit 2. *x: Where Class D test has failed mA/W. <L2 (A) Reading is below 200% Class A Only. N/A : Harmonic current below 0.6% of rated current or 5mA, whichever is greater Or where the test is not applicable.								
Harm	Limit1	Limit2	Avg Rdg	<L1	<L2	Max Rdg	<L2(A)	PassFail
2	8.03mA	12.045mA	392.51uA	N/A	N/A	439.74uA	N/A	Pass
3	109.13mA	163.70mA	35.320mA	√	√	35.413mA	N/A	Pass
4	N/A	N/A	N/A	N/A	N/A	N/A	N/A	N/A
5	40.15mA	60.225mA	5.8642mA	√	√	6.0307mA	N/A	Pass
6	N/A	N/A	N/A	N/A	N/A	N/A	N/A	N/A
7	28.105mA	42.157mA	2.8301mA	N/A	N/A	2.9105mA	N/A	Pass
8	N/A	N/A	N/A	N/A	N/A	N/A	N/A	N/A
9	20.075mA	30.112mA	4.4183mA	N/A	N/A	4.5284mA	N/A	Pass
10	N/A	N/A	N/A	N/A	N/A	N/A	N/A	N/A
11	12.045mA	18.067mA	4.2518mA	N/A	N/A	4.3112mA	N/A	Pass
12	N/A	N/A	N/A	N/A	N/A	N/A	N/A	N/A
13	12.045mA	18.067mA	4.4052mA	N/A	N/A	4.4703mA	N/A	Pass
14	N/A	N/A	N/A	N/A	N/A	N/A	N/A	N/A
15	12.045mA	18.067mA	5.2873mA	√	√	5.3438mA	N/A	Pass
16	N/A	N/A	N/A	N/A	N/A	N/A	N/A	N/A
17	12.045mA	18.067mA	6.2557mA	√	√	6.3697mA	N/A	Pass
18	N/A	N/A	N/A	N/A	N/A	N/A	N/A	N/A
19	12.045mA	18.067mA	6.9573mA	√	√	7.044mA	N/A	Pass
20	N/A	N/A	N/A	N/A	N/A	N/A	N/A	N/A
21	12.045mA	18.067mA	6.8674mA	√	√	6.9895mA	N/A	Pass
22	N/A	N/A	N/A	N/A	N/A	N/A	N/A	N/A
23	12.045mA	18.067mA	5.1907mA	√	√	5.2708mA	N/A	Pass
24	N/A	N/A	N/A	N/A	N/A	N/A	N/A	N/A
25	12.045mA	18.067mA	3.9413mA	N/A	N/A	4.0163mA	N/A	Pass
26	N/A	N/A	N/A	N/A	N/A	N/A	N/A	N/A
27	12.045mA	18.067mA	1.9888mA	N/A	N/A	2.0764mA	N/A	Pass
28	N/A	N/A	N/A	N/A	N/A	N/A	N/A	N/A
29	12.045mA	18.067mA	1.5153mA	N/A	N/A	1.5804mA	N/A	Pass
30	N/A	N/A	N/A	N/A	N/A	N/A	N/A	N/A
31	12.045mA	18.067mA	918.62uA	N/A	N/A	970.26uA	N/A	Pass
32	N/A	N/A	N/A	N/A	N/A	N/A	N/A	N/A
33	12.045mA	18.067mA	852.27uA	N/A	N/A	921.39uA	N/A	Pass
34	N/A	N/A	N/A	N/A	N/A	N/A	N/A	N/A
35	12.045mA	18.067mA	875.08uA	N/A	N/A	943.05uA	N/A	Pass
36	N/A	N/A	N/A	N/A	N/A	N/A	N/A	N/A
37	12.045mA	18.067mA	741.90uA	N/A	N/A	800.19uA	N/A	Pass
38	N/A	N/A	N/A	N/A	N/A	N/A	N/A	N/A
39	12.045mA	18.067mA	842.32uA	N/A	N/A	1.0056mA	N/A	Pass
40	N/A	N/A	N/A	N/A	N/A	N/A	N/A	N/A

Figure 32. IEC61000-3-2 Report 277 V 50% Load 60 Hz

onsemi, **Onsemi**, and other names, marks, and brands are registered and/or common law trademarks of Semiconductor Components Industries, LLC dba "**onsemi**" or its affiliates and/or subsidiaries in the United States and/or other countries. **onsemi** owns the rights to a number of patents, trademarks, copyrights, trade secrets, and other intellectual property. A listing of **onsemi**'s product/patent coverage may be accessed at www.onsemi.com/site/pdf/Patent-Marking.pdf. **onsemi** is an Equal Opportunity/Affirmative Action Employer. This literature is subject to all applicable copyright laws and is not for resale in any manner.

The evaluation board/kit (research and development board/kit) (hereinafter the "board") is not a finished product and is not available for sale to consumers. The board is only intended for research, development, demonstration and evaluation purposes and will only be used in laboratory/development areas by persons with an engineering/technical training and familiar with the risks associated with handling electrical/mechanical components, systems and subsystems. This person assumes full responsibility/liability for proper and safe handling. Any other use, resale or redistribution for any other purpose is strictly prohibited.

THE BOARD IS PROVIDED BY ONSEMI TO YOU "AS IS" AND WITHOUT ANY REPRESENTATIONS OR WARRANTIES WHATSOEVER. WITHOUT LIMITING THE FOREGOING, ONSEMI (AND ITS LICENSORS/SUPPLIERS) HEREBY DISCLAIMS ANY AND ALL REPRESENTATIONS AND WARRANTIES IN RELATION TO THE BOARD, ANY MODIFICATIONS, OR THIS AGREEMENT, WHETHER EXPRESS, IMPLIED, STATUTORY OR OTHERWISE, INCLUDING WITHOUT LIMITATION ANY AND ALL REPRESENTATIONS AND WARRANTIES OF MERCHANTABILITY, FITNESS FOR A PARTICULAR PURPOSE, TITLE, NON-INFRINGEMENT, AND THOSE ARISING FROM A COURSE OF DEALING, TRADE USAGE, TRADE CUSTOM OR TRADE PRACTICE.

onsemi reserves the right to make changes without further notice to any board.

You are responsible for determining whether the board will be suitable for your intended use or application or will achieve your intended results. Prior to using or distributing any systems that have been evaluated, designed or tested using the board, you agree to test and validate your design to confirm the functionality for your application. Any technical, applications or design information or advice, quality characterization, reliability data or other services provided by **onsemi** shall not constitute any representation or warranty by **onsemi**, and no additional obligations or liabilities shall arise from **onsemi** having provided such information or services.

onsemi products including the boards are not designed, intended, or authorized for use in life support systems, or any FDA Class 3 medical devices or medical devices with a similar or equivalent classification in a foreign jurisdiction, or any devices intended for implantation in the human body. You agree to indemnify, defend and hold harmless **onsemi**, its directors, officers, employees, representatives, agents, subsidiaries, affiliates, distributors, and assigns, against any and all liabilities, losses, costs, damages, judgments, and expenses, arising out of any claim, demand, investigation, lawsuit, regulatory action or cause of action arising out of or associated with any unauthorized use, even if such claim alleges that **onsemi** was negligent regarding the design or manufacture of any products and/or the board.

This evaluation board/kit does not fall within the scope of the European Union directives regarding electromagnetic compatibility, restricted substances (RoHS), recycling (WEEE), FCC, CE or UL, and may not meet the technical requirements of these or other related directives.

FCC WARNING – This evaluation board/kit is intended for use for engineering development, demonstration, or evaluation purposes only and is not considered by **onsemi** to be a finished end product fit for general consumer use. It may generate, use, or radiate radio frequency energy and has not been tested for compliance with the limits of computing devices pursuant to part 15 of FCC rules, which are designed to provide reasonable protection against radio frequency interference. Operation of this equipment may cause interference with radio communications, in which case the user shall be responsible, at its expense, to take whatever measures may be required to correct this interference.

onsemi does not convey any license under its patent rights nor the rights of others.

LIMITATIONS OF LIABILITY: **onsemi** shall not be liable for any special, consequential, incidental, indirect or punitive damages, including, but not limited to the costs of requalification, delay, loss of profits or goodwill, arising out of or in connection with the board, even if **onsemi** is advised of the possibility of such damages. In no event shall **onsemi**'s aggregate liability from any obligation arising out of or in connection with the board, under any theory of liability, exceed the purchase price paid for the board, if any.

The board is provided to you subject to the license and other terms per **onsemi**'s standard terms and conditions of sale. For more information and documentation, please visit www.onsemi.com.

ADDITIONAL INFORMATION

TECHNICAL PUBLICATIONS:

Technical Library: www.onsemi.com/design/resources/technical-documentation
onsemi Website: www.onsemi.com

ONLINE SUPPORT: www.onsemi.com/support

For additional information, please contact your local Sales Representative at www.onsemi.com/support/sales