

NCV8871BSTGEVB

NCV8871 Automotive Grade Boost Controller Audio Amplifier Evaluation Board User's Manual



ON Semiconductor®

www.onsemi.com

EVAL BOARD USER'S MANUAL

Description

The NCV8871BST evaluation board provides an opportunity to evaluate the NCV887100 in an audio amplifier power supply type application. The board supplies an 18 V output with 9 A of output current from as low as a 6 V input. The enable pin can also be used to synchronize the supply to an external clock.

Key Features

- 18 V Output Voltage
- 9 A Output Current
- Fixed Frequency Operation at 170 kHz
- Regulates Fully Loaded From as Low as 6 V Input
- Survives 40 V Load Dump
- External Clock Synchronization up to 340 kHz
- Automotive Grade



Figure 1. NCV8871BSTGEVB Evaluation Board

NCV8871BSTGEVB

Table 1. EVALUATION BOARD TERMINAL DESCRIPTIONS

Terminal	Function
VIN	Positive dc input voltage.
GND	Common dc return.
VOUT	Dc output voltage.
EN/SYNC	Dc enable voltage and external clock synchronization. A dc logic low disables the device.

Table 2. ABSOLUTE MAXIMUM RATINGS (Voltages are with respect to GND)

Rating	Value	Unit
Dc Supply Voltage (VIN)	-0.3 to 40	V
Dc Supply Voltage (EN/SYNC)	-0.3 to 6	V
Ambient Temperature	-40 to 85	°C

Stresses exceeding those listed in the Maximum Ratings table may damage the device. If any of these limits are exceeded, device functionality should not be assumed, damage may occur and reliability may be affected.

Table 3. ELECTRICAL CHARACTERISTICS

(TA = 25°C, 4.5 ≤ VIN ≤ 18 V, IOUT ≤ 2 A, unless otherwise specified)

Characteristic	Conditions	Typical Value	Unit
OUTPUT VOLTAGE			
Output Voltage		18.00	V
Voltage Accuracy	-40 ≤ TA ≤ 85	4	%
Soft-start Time		7.4	ms
SWITCHING REGULATOR			
Switching Frequency		170	kHz
SYNC Frequency		170 to 340	kHz
Duty Cycle Range		2 to 88	%
Current Limit			
Cycle-by-cycle current limit		50	A
General			
Input Undervoltage Lockout (UVLO)	VIN increasing	3.8	V
Efficiency	VIN = 13.2 V, IOUT = 5 A	85	%
Thermal Shutdown		170	°C

NCV8871BSTGEVB

TYPICAL WAVEFORMS

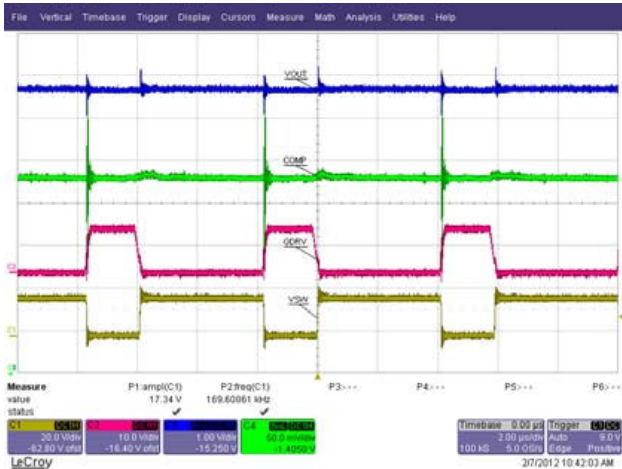

Figure 2. Normal Operation

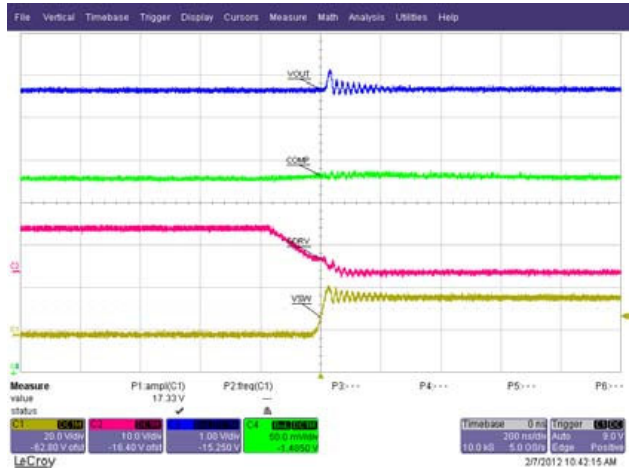

Figure 3. Gate Drive Falling Edge

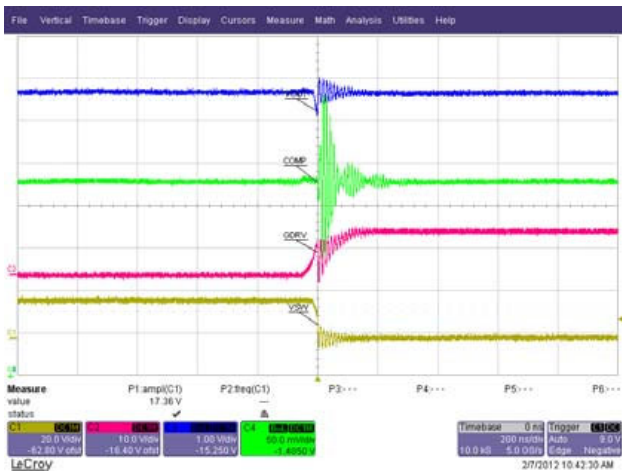

Figure 4. Gate Drive Rising Edge

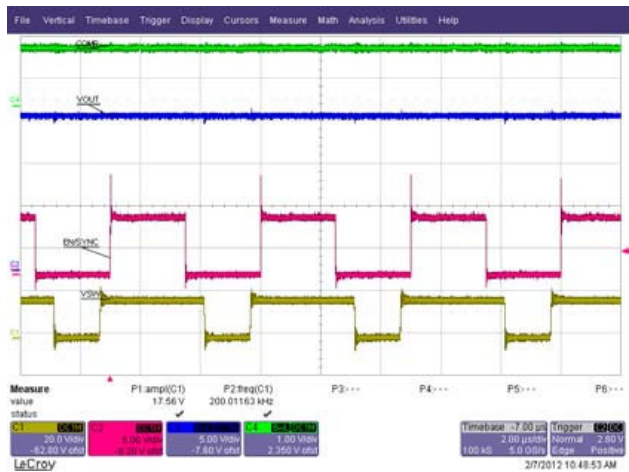

Figure 5. Synchronization

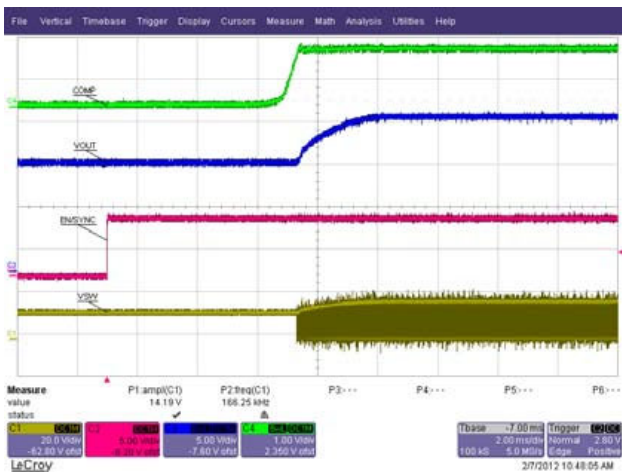

Figure 6. Soft Start with Load

NCV8871BSTGEVB

SCHEMATIC

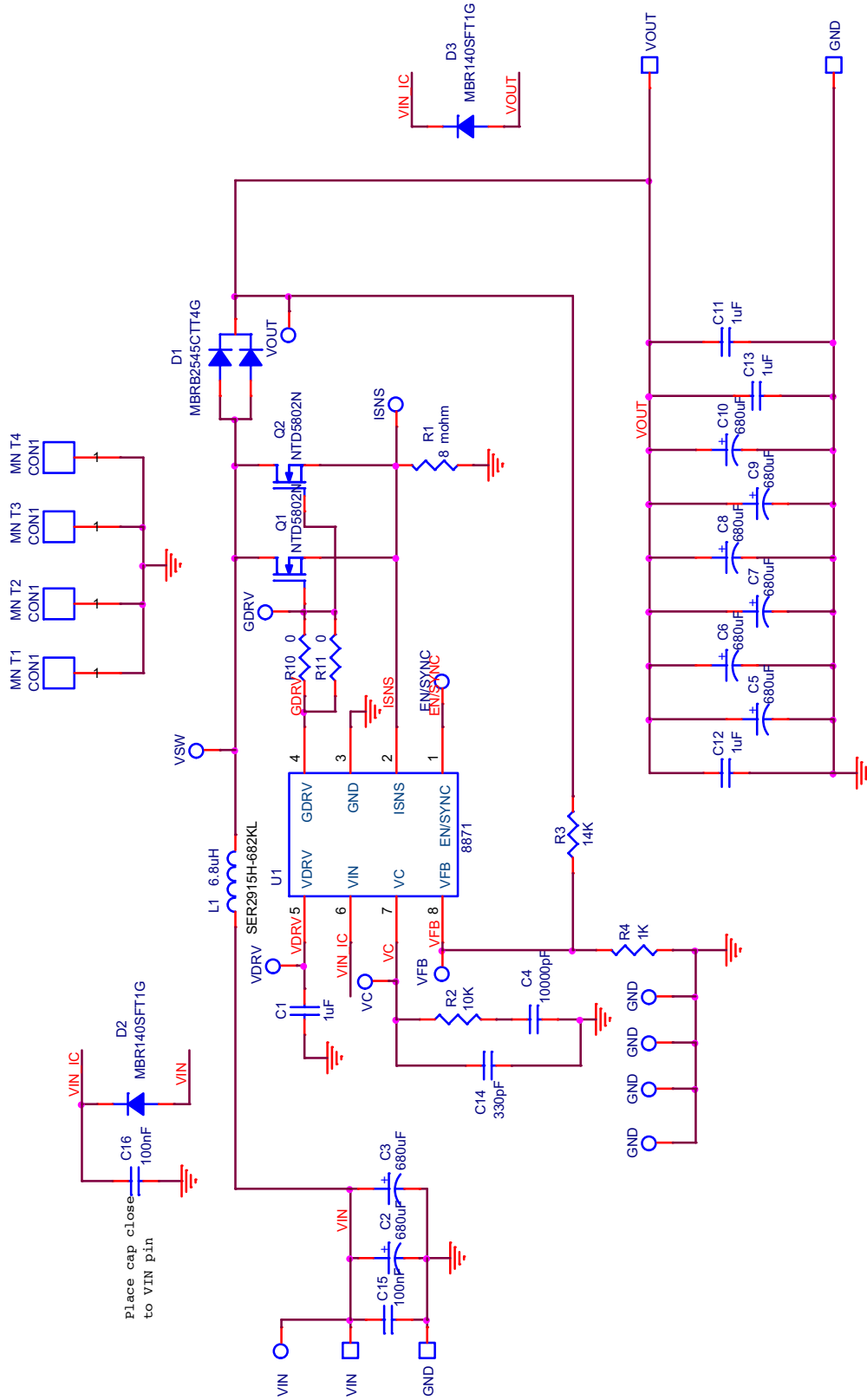

Figure 7. NCV8871BSTGEVB Evaluation Board Schematic

NCV8871BSTGEVB

PCB Layout

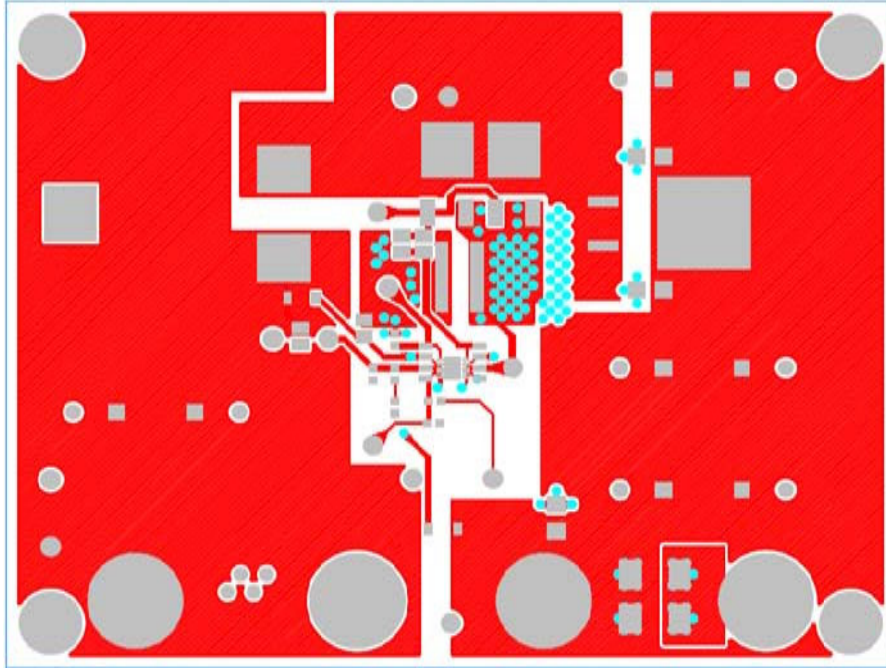

Figure 8. Top Layout

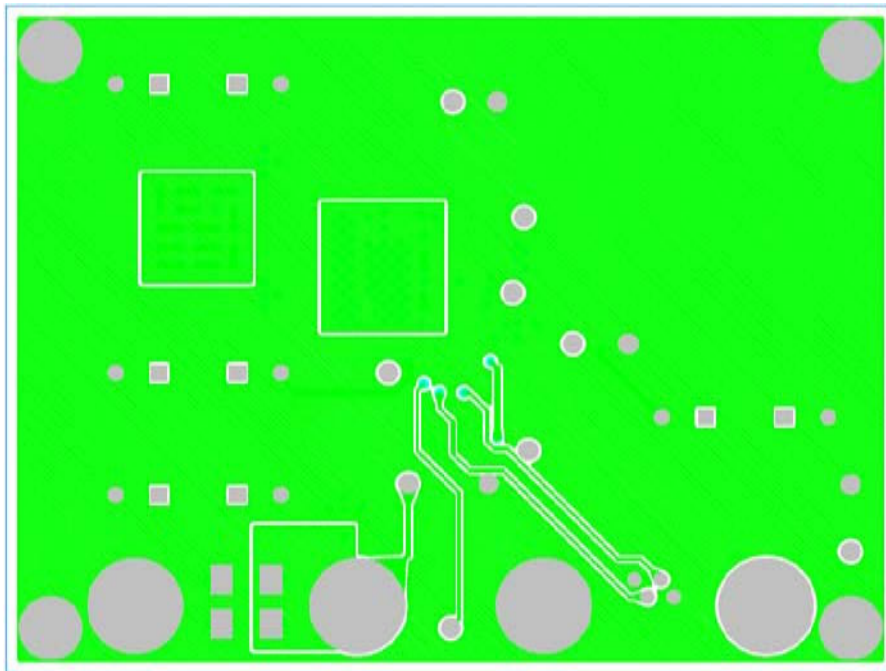

Figure 9. Bottom Layout

NCV8871BSTGEVB

Table 4. BILL OF MATERIALS

Reference Designator(s)	QTY	Description	Value	Tolerance	Footprint	Manufacturer	Manufacturer's Part Number	Substitution Allowed	RoHS Compliant
C1	1	CAP CER 1UF 16V X7R 0603	1 uF	10%	603	Murata Electronics North America	GRM188R71C105KA12D	Yes	Yes
C2, C3	2	CAP ELECT 1000UF 50V FK SMD	1000 uF	20%	FKV_CAP	Panasonic - ECG	EEE-FK1H102AM	No	Yes
C4	1	CAP CER 33000PF 50V X7R 0603	33000 pF	10%	603	Murata Electronics North America	GRM188R71H333KA61D	No	Yes
C5 thru C10, C18 thru C20	9	CAP 180UF 50V ELECT FM RADIAL	180 uF	20%	CAP_8P0	Murata Electronics North America	EEU-FM1H181L	No	Yes
C11, C12, C13	3	CAP CER 1UF 50V X7R 1206	1 uF	10%	1206	Murata Electronics North America	GCM31MR71H105KA55L	Yes	Yes
C14	1	CAP CER 2700PF 100V 10% X7R 0603	2700 pF	10%	603	Murata Electronics North America	GRM188R72A272KA01D	No	Yes
C15, C16	2	CAP CER .1UF 50V 10% X7R 0805	100 nF	10%	805	Murata Electronics North America	GRM21BR71H104KA01L	Yes	Yes
C17	1	Do Not Populate			603			Yes	Yes
D1	1	45V, 30A D2PAK Schottky Rectifier	45 V / 30 A	N/A	D2PAK_3	ON Semiconductor	MBRB2545CTT4G	No	Yes
D2, D3	2	DIODE SCHOTTKY 40V 1A SOD123FL	40 V / 1 A	N/A	SOD_123	ON Semiconductor	MBR140SFT1G	No	Yes
J1	1	CONN HEADER 4POS R/A 1.5MM TIN	N/A	N/A	4PINCONN	Coilcraft Inc	292206-4	No	Yes
L1	1	High Temp SMT Power Inductor 6.8uH	6.8 uH	30A	SER2900	Coilcraft Inc	SER2915H-682KL	No	Yes
Q1, Q2	2	MOSFET N-CH 40V 101A DPAK	40 V / 101 A	N/A	DPAK3_DMD	ON Semiconductor	NTD5802NT4G	No	Yes
R1	1	RES 0.008 OHM 3W 1% 3015 SMD	0.008	1%	3015	Susumu	KRL7638-C-R008-F-T1	No	Yes
R2	1	RES 6.34K OHM 1/10W 1% 0603 SMD	6.34 K	1%	603	Vishay/Dale	CRCW06036K34FKEA	Yes	Yes
R3	1	RES 14.0K OHM 1/10W 1% 0603 SMD	14.0 K	1%	603	Vishay/Dale	CRCW060314K0FKEA	Yes	Yes
R4	1	RES 1.00K OHM 1/10W 1% 0603 SMD	1.00 K	1%	603	Vishay/Dale	CRCW06031K00FKEA	Yes	Yes
R10, R11	2	RES 0.0 OHM 1/8W 0805 SMD	0	5%	805	Vishay/Dale	CRCW08050000Z0EA	Yes	Yes
TP1 thru 6, 7, 9, 14 thru 17, 20	13	PIN INBOARD .042" HOLE 1000/PKG	N/A	N/A	TP	Vector Electronics	K24C/M	Yes	Yes
TP10, 11, 12, 13	4	CONN JACK BANANA UNINS PANEL MOU	N/A	N/A	BANANA	Emerson Network Power Conn Solutions	108-0740-001	No	Yes
U1	1	Automotive Non-Sync Boost Controller	N/A	N/A	SOIC8_N_ADJ	ON Semiconductor	NCV8871_00	No	Yes
U2	1	Automotive Non-Sync Boost Controller	N/A	N/A	10PINDFNP5	ON Semiconductor	NCV8872_00	No	Yes
MNT1, 2, 3, 4	4	Hex Spacer 4-40 1/2" Zinc Plated Steel	N/A	N/A	MOUN-THOLE125	McMaster-Carr	93620A432	Yes	Yes
	4	Hex Nut 4-40 1/4" Zinc Plated Steel	N/A	N/A	MOUN-THOLE125	McMaster-Carr	90480A005	Yes	Yes

onsemi, **Onsemi**, and other names, marks, and brands are registered and/or common law trademarks of Semiconductor Components Industries, LLC dba "**onsemi**" or its affiliates and/or subsidiaries in the United States and/or other countries. **onsemi** owns the rights to a number of patents, trademarks, copyrights, trade secrets, and other intellectual property. A listing of **onsemi**'s product/patent coverage may be accessed at www.onsemi.com/site/pdf/Patent-Marking.pdf. **onsemi** is an Equal Opportunity/Affirmative Action Employer. This literature is subject to all applicable copyright laws and is not for resale in any manner.

The evaluation board/kit (research and development board/kit) (hereinafter the "board") is not a finished product and is not available for sale to consumers. The board is only intended for research, development, demonstration and evaluation purposes and will only be used in laboratory/development areas by persons with an engineering/technical training and familiar with the risks associated with handling electrical/mechanical components, systems and subsystems. This person assumes full responsibility/liability for proper and safe handling. Any other use, resale or redistribution for any other purpose is strictly prohibited.

THE BOARD IS PROVIDED BY ONSEMI TO YOU "AS IS" AND WITHOUT ANY REPRESENTATIONS OR WARRANTIES WHATSOEVER. WITHOUT LIMITING THE FOREGOING, ONSEMI (AND ITS LICENSORS/SUPPLIERS) HEREBY DISCLAIMS ANY AND ALL REPRESENTATIONS AND WARRANTIES IN RELATION TO THE BOARD, ANY MODIFICATIONS, OR THIS AGREEMENT, WHETHER EXPRESS, IMPLIED, STATUTORY OR OTHERWISE, INCLUDING WITHOUT LIMITATION ANY AND ALL REPRESENTATIONS AND WARRANTIES OF MERCHANTABILITY, FITNESS FOR A PARTICULAR PURPOSE, TITLE, NON-INFRINGEMENT, AND THOSE ARISING FROM A COURSE OF DEALING, TRADE USAGE, TRADE CUSTOM OR TRADE PRACTICE.

onsemi reserves the right to make changes without further notice to any board.

You are responsible for determining whether the board will be suitable for your intended use or application or will achieve your intended results. Prior to using or distributing any systems that have been evaluated, designed or tested using the board, you agree to test and validate your design to confirm the functionality for your application. Any technical, applications or design information or advice, quality characterization, reliability data or other services provided by **onsemi** shall not constitute any representation or warranty by **onsemi**, and no additional obligations or liabilities shall arise from **onsemi** having provided such information or services.

onsemi products including the boards are not designed, intended, or authorized for use in life support systems, or any FDA Class 3 medical devices or medical devices with a similar or equivalent classification in a foreign jurisdiction, or any devices intended for implantation in the human body. You agree to indemnify, defend and hold harmless **onsemi**, its directors, officers, employees, representatives, agents, subsidiaries, affiliates, distributors, and assigns, against any and all liabilities, losses, costs, damages, judgments, and expenses, arising out of any claim, demand, investigation, lawsuit, regulatory action or cause of action arising out of or associated with any unauthorized use, even if such claim alleges that **onsemi** was negligent regarding the design or manufacture of any products and/or the board.

This evaluation board/kit does not fall within the scope of the European Union directives regarding electromagnetic compatibility, restricted substances (RoHS), recycling (WEEE), FCC, CE or UL, and may not meet the technical requirements of these or other related directives.

FCC WARNING – This evaluation board/kit is intended for use for engineering development, demonstration, or evaluation purposes only and is not considered by **onsemi** to be a finished end product fit for general consumer use. It may generate, use, or radiate radio frequency energy and has not been tested for compliance with the limits of computing devices pursuant to part 15 of FCC rules, which are designed to provide reasonable protection against radio frequency interference. Operation of this equipment may cause interference with radio communications, in which case the user shall be responsible, at its expense, to take whatever measures may be required to correct this interference.

onsemi does not convey any license under its patent rights nor the rights of others.

LIMITATIONS OF LIABILITY: **onsemi** shall not be liable for any special, consequential, incidental, indirect or punitive damages, including, but not limited to the costs of requalification, delay, loss of profits or goodwill, arising out of or in connection with the board, even if **onsemi** is advised of the possibility of such damages. In no event shall **onsemi**'s aggregate liability from any obligation arising out of or in connection with the board, under any theory of liability, exceed the purchase price paid for the board, if any.

The board is provided to you subject to the license and other terms per **onsemi**'s standard terms and conditions of sale. For more information and documentation, please visit www.onsemi.com.

ADDITIONAL INFORMATION

TECHNICAL PUBLICATIONS:

Technical Library: www.onsemi.com/design/resources/technical-documentation
onsemi Website: www.onsemi.com

ONLINE SUPPORT: www.onsemi.com/support

For additional information, please contact your local Sales Representative at www.onsemi.com/support/sales