

# ON Semiconductor

## Is Now

# onsemi™

To learn more about onsemi™, please visit our website at  
[www.onsemi.com](http://www.onsemi.com)

---

**onsemi** and **onsemi** and other names, marks, and brands are registered and/or common law trademarks of Semiconductor Components Industries, LLC dba "**onsemi**" or its affiliates and/or subsidiaries in the United States and/or other countries. **onsemi** owns the rights to a number of patents, trademarks, copyrights, trade secrets, and other intellectual property. A listing of **onsemi** product/patent coverage may be accessed at [www.onsemi.com/site/pdf/Patent-Marking.pdf](http://www.onsemi.com/site/pdf/Patent-Marking.pdf). **onsemi** reserves the right to make changes at any time to any products or information herein, without notice. The information herein is provided "as-is" and **onsemi** makes no warranty, representation or guarantee regarding the accuracy of the information, product features, availability, functionality, or suitability of its products for any particular purpose, nor does **onsemi** assume any liability arising out of the application or use of any product or circuit, and specifically disclaims any and all liability, including without limitation special, consequential or incidental damages. Buyer is responsible for its products and applications using **onsemi** products, including compliance with all laws, regulations and safety requirements or standards, regardless of any support or applications information provided by **onsemi**. "Typical" parameters which may be provided in **onsemi** data sheets and/or specifications can and do vary in different applications and actual performance may vary over time. All operating parameters, including "Typicals" must be validated for each customer application by customer's technical experts. **onsemi** does not convey any license under any of its intellectual property rights nor the rights of others. **onsemi** products are not designed, intended, or authorized for use as a critical component in life support systems or any FDA Class 3 medical devices or medical devices with a same or similar classification in a foreign jurisdiction or any devices intended for implantation in the human body. Should Buyer purchase or use **onsemi** products for any such unintended or unauthorized application, Buyer shall indemnify and hold **onsemi** and its officers, employees, subsidiaries, affiliates, and distributors harmless against all claims, costs, damages, and expenses, and reasonable attorney fees arising out of, directly or indirectly, any claim of personal injury or death associated with such unintended or unauthorized use, even if such claim alleges that **onsemi** was negligent regarding the design or manufacture of the part. **onsemi** is an Equal Opportunity/Affirmative Action Employer. This literature is subject to all applicable copyright laws and is not for resale in any manner. Other names and brands may be claimed as the property of others.



## Universal AC Input, Non-isolated 6 W E-meter Buck Power Supply

### DESIGN NOTE

**Table 1. DEVICE DETAILS**

Device	Application	Input Voltage	Output Power	Topology	I/O Isolation
NCP1219B, NCP431, NDD05N50	Smart Meters, Electric Meters	60 to 300 Vac	6 W Nominal	Buck Converter	Non-isolated

Characteristic	Output Specification
Output Voltage	12 Vdc ±1%
Ripple	100 mV p/p @ Full Load
Nominal Current	500 mA Continuous
Max Current	1.0 A Maximum (10 Second Surge)
Min Current	Zero

PFC (Yes/No)	No, (Pout < 25 W)
Efficiency	77% at Nominal Load @ 120 Vac
Inrush Limiting/Fuse	Inrush Resistor (R1)
Operating Temp. Range	0 to +60°C
Cooling Method/Supply Orientation	Convection
Signal Level Control	None

#### Circuit Description

This design note describes a simple, low power, off-line, extended universal AC input buck power supply intended for powering utility electric meters or similar industrial equipment or white goods where isolation from the AC mains is not required and low cost and circuit simplicity is essential.

The featured power supply is a simple buck regulator topology utilizing ON Semiconductor's NCP1219B current mode PWM controller driving an external DPAK MOSFET (Q1). The controller circuitry is ground referenced to the freewheel diode's cathode terminal which is a switched node. This allows for simple half-wave input rectification and a common AC input to dc output node. Because the NCP1219 controller and its associated circuitry are at a switched node, optocoupler feedback from the NCP431 output sensing amplifier is utilized to avoid regulation inaccuracies typically caused by charge pump and/or bootstrap type sensing schemes. Diode D4 also powers the control circuitry from the output voltage once the converter has started.

The half-wave input rectifier section utilizes a pi-network, split bulk capacitor scheme which provides for both high input transient protection (with optional TVS1) and effective conducted EMI attenuation. The choice of the total bulk capacitance can be selected for the desired output hold-up time during line cycle outages or extreme brownout conditions. Hold-up time along with efficiency and output ripple plots are shown below.

#### Key Features

- Extended Universal AC Input Range (60–300 Vac) with up to 10 W Peak Output
- Bulk Pi-network Filter for Conducted EMI Attenuation and Input Transient Protection
- AC Input to DC Output Common Node
- Inherent Over-current Protection and Optional Z1 Over-voltage Protection Clamp
- Simple, Low Cost Circuitry with Off-the-Shelf Output Inductor (L2)

CIRCUIT SCHEMATIC

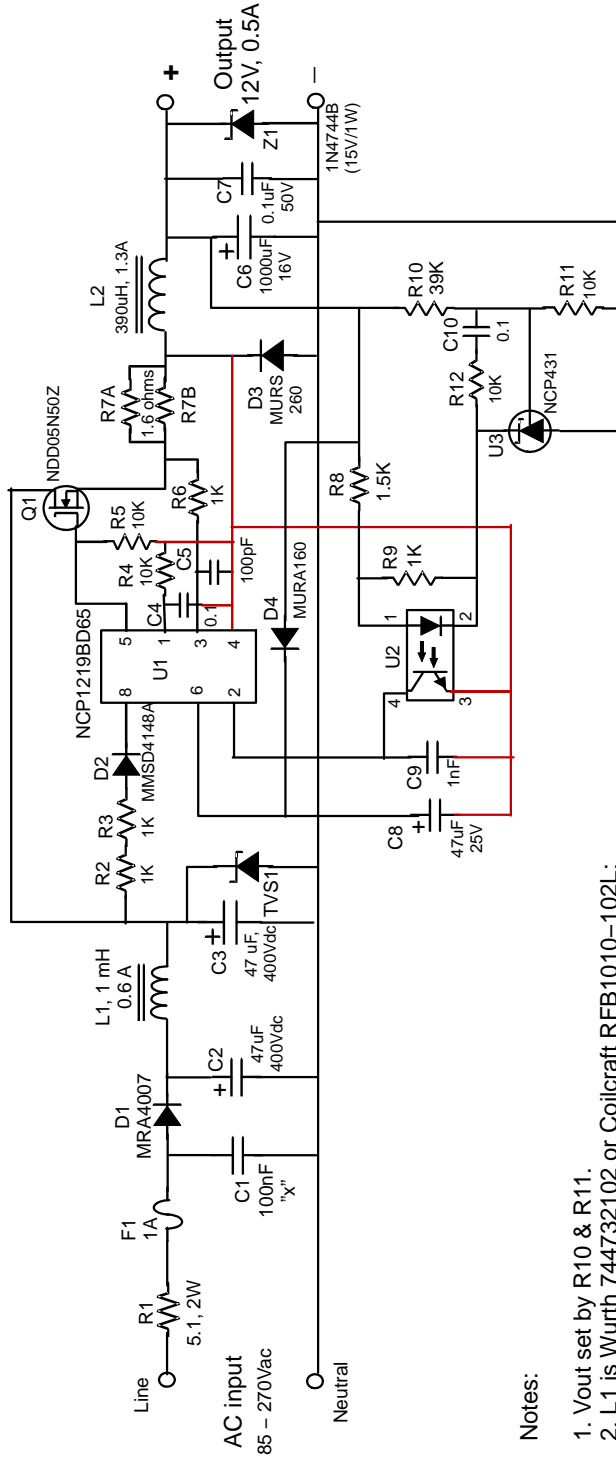

Notes:

1. Vout set by R10 & R11.
2. L1 is Wurth 744732102 or Coilcraft RFB1010-102L;  
L2 is Coilcraft PCX-45X-394LT.
3. Red lines indicate areas/traces that should be minimized for capacitance.
4. D3 should be heatsunk via ground tab to as large as possible copper clad area.
5. D3 should have large pad areas for heatsinking.
6. R1 should be wire wound or carbon composition for high joule rating.
7. Z2 is optional output OVP zener.
8. Crossed schematic lines are not connected.
9. U2 is NEC PS2561L-1 optocoupler or similar (CTR > 0.5)
10. TVS1 is optional transient suppressor

6W Off-Line Buck Converter Using NCP1219B65  
With Optocoupler Voltage Sensing (Rev 5)

# DN05014/D

## Efficiency vs Load (NCP1219 Buck)

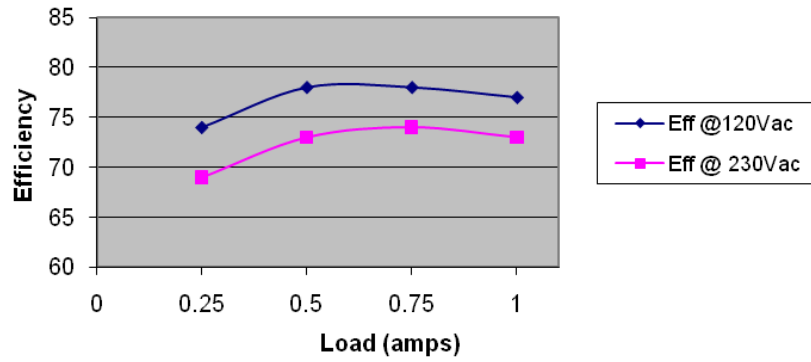

Figure 1. Efficiency Plots at 120 Vac and 230 Vac

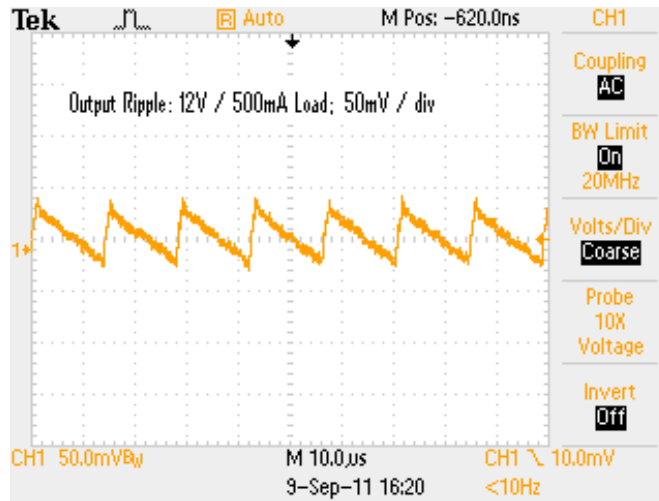

Figure 2. Full Load Output Ripple

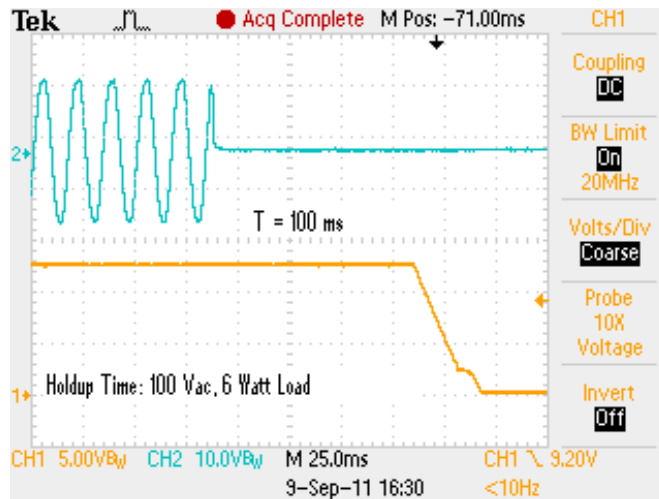

Figure 3. Hold-up Time at 100 Vac with  $C_{bulk} = 94 \mu F$

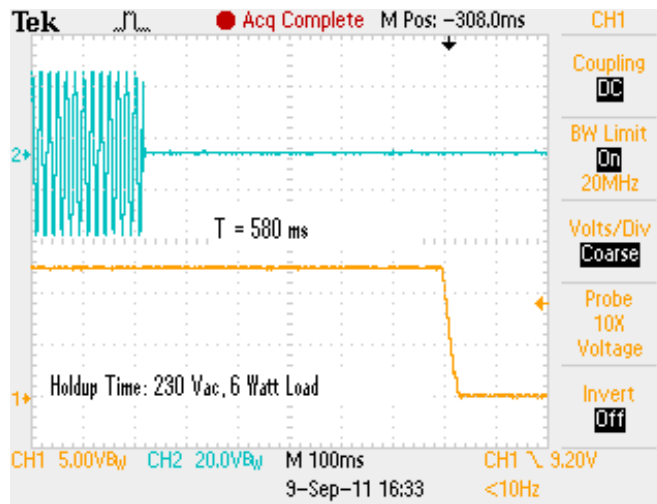
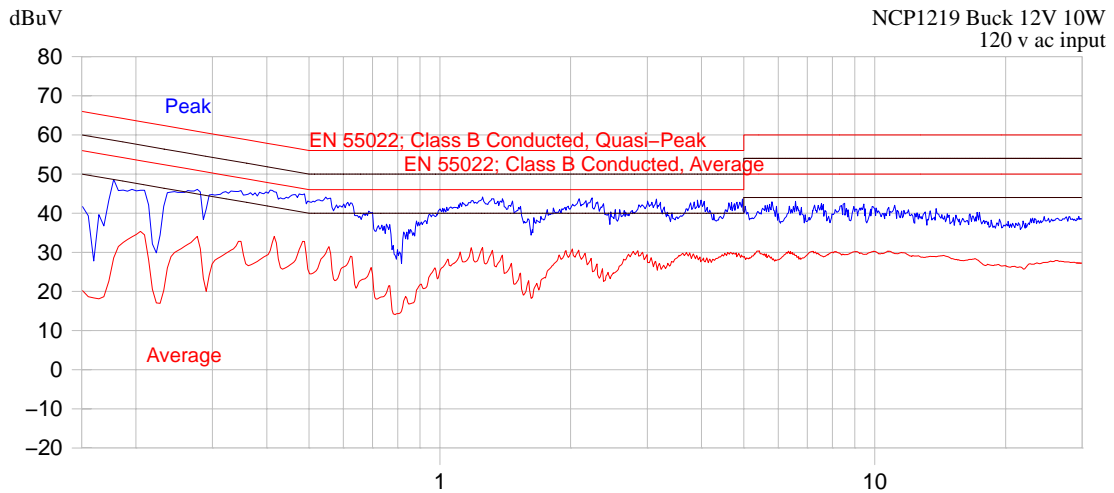

Figure 4. Hold-up Time at 230 Vac with  $C_{bulk} = 94 \mu F$



9/14/2011 8:00:53 AM

(Start = 0.15, Stop = 30.00) MHz

Figure 5. EMI Profile – Peak (Blue) and Average (Red) Plots

# DN05014/D

## BILL OF MATERIALS

**Table 2. BILL OF MATERIALS FOR 12 Vout, 6 W NCP1219 OFF-LINE BUCK CONVERTER**

Designator	Qty	Description	Value	Tolerance	Footprint	Manufacturer	Manufacturer Part Number	Substitution Allowed
Q1	1	Mosfet – NDD05N50Z	5 A, 500 V		DPAK	ON Semiconductor	NDD05N50Z	No
D1	1	Diode – 60 Hz,	1 A, 1 kV		SMA	ON Semiconductor	MRA4007	No
D3	1	Diode – Ultra Fast Recov	2 A, 600 V		SMC	ON Semiconductor	MURS260	No
D4	1	Diode – Ultra Fast Recov	1 A, 600 V		SMA	ON Semiconductor	MURA160T3	
D2	1	Signal Diode	100 mA, 100 V		SOD-123	ON Semiconductor	MMSD4148A	No
Z1	1	Zener Diode – 15V	1 W, 15 V		Axial Lead	TBD	1N4744A	
U3	1	Programmable Zener	2.5 V		SOIC8/SOT23	ON Semiconductor	NCP431A	No
U2	1	Optocoupler	CTR >= 0.5		4-pin	Vishay or NEC	SFH6156A-4 or PS2561L-1	Yes
U1	1	Controller – NCP1219BD65	65 kHz		SOIC8	ON Semiconductor	NCP1219BD65	No
TVS1	1	Voltage Suppressor	TBD (optional)		Axial Lead; LS = 0.8", Fat Leads	ON Semiconductor	TBD – optional	
C1	1	"X" Cap, Box Type	100 nF, X2		LS = 15 mm	Rifa, Wima	TBD	Yes
C2, C3	2	Electrolytic Cap	47 µF, 400 V	10%	LS = 7.5 mm, D = 16 mm	UCC, Panasonic	TBD	Yes
C9	1	Ceramic Cap, Monolithic	1 nF, 50 V	10%	1206	AVX, Murata	TBD	Yes
C4, C7, C10	3	Ceramic Cap, Monolithic	100 nF, 50 V	10%	1206	AVX, Murata	TBD	Yes
C5	1	Ceramic Cap, Monolithic	100 pF, 50 V	10%	1206	AVX, Murata	TBD	Yes
C8	1	Electrolytic Cap	47 µF, 25 Vdc	10%	LS = 2.5 mm, D = 6.3 mm	UCC, Panasonic	TBD	Yes
C6	1	Electrolytic Cap	1000 µF, 16 V	10%	LS = 5 mm, D = 12.5 mm	UCC, Panasonic	TBD	Yes
R1	1	Resistor, 5 W, Wire Wound	5.1 Ω, 5 W	10%	LS = 7.5 mm, D = 7 mm	Ohmite, Dale	TBD	Yes
R4, R5, R11, R12	4	Resistor, 1/4 W SMD	10 kΩ	1%	SMD 1206	AVX, Vishay, Dale	TBD	
R7A, R7B	2	Resistor, 1/4 W SMD	1.6 Ω	1%	SMD 1206	AVX, Vishay, Dale	TBD	Yes
R2, R3, R6, R9	4	Resistor, 1/4 W SMD	1 kΩ	5%	SMD 1206	AVX, Vishay, Dale	TBD	Yes
R8	1	Resistor, 1/4 W SMD	1.5 kΩ	5%	SMD 1206	AVX, Vishay, Dale	TBD	Yes
R10	1	Resistor, 1/4 W SMD	39 kΩ	1%	SMD 1206	AVX, Vishay, Dale	TBD	
F1	1	Fuse, TR-5 Style	1 A		TR-5, LS = 5 mm	Minifuse		Yes
L1	1	Inductor (EMI Choke)	1 mH, 600 mA		Dia = 11 mm, LS = 5 mm	Coilcraft	RFB1010-102L	Yes
L2	1	Buck Inductor – 390 µH	390 µH, 1.3 A		Axial Lead LS=26mm, Dia=11mm	Coilcraft	PCH-45X-394LT	
J1, J2	2	Screw Terminal			LS = 0.2"	DigiKey	#281-1435-ND	Yes

# DN05014/D

## REFERENCES

- [1] ON Semiconductor data sheet for [NCP1219](#) controller in SOIC8 package.
- [2] ON Semiconductor Design Notes [DN06011/D](#), [DN06037/D](#), [DN06066/D](#).
- [3] ON Semiconductor Application Note [AND8318/D](#).

ON Semiconductor and the  are registered trademarks of Semiconductor Components Industries, LLC (SCILLC) or its subsidiaries in the United States and/or other countries. SCILLC owns the rights to a number of patents, trademarks, copyrights, trade secrets, and other intellectual property. A listing of SCILLC's product/patent coverage may be accessed at [www.onsemi.com/site/pdf/Patent-Marking.pdf](http://www.onsemi.com/site/pdf/Patent-Marking.pdf). SCILLC reserves the right to make changes without further notice to any products herein. SCILLC makes no warranty, representation or guarantee regarding the suitability of its products for any particular purpose, nor does SCILLC assume any liability arising out of the application or use of any product or circuit, and specifically disclaims any and all liability, including without limitation special, consequential or incidental damages. "Typical" parameters which may be provided in SCILLC data sheets and/or specifications can and do vary in different applications and actual performance may vary over time. All operating parameters, including "Typicals" must be validated for each customer application by customer's technical experts. SCILLC does not convey any license under its patent rights nor the rights of others. SCILLC products are not designed, intended, or authorized for use as components in systems intended for surgical implant into the body, or other applications intended to support or sustain life, or for any other application in which the failure of the SCILLC product could create a situation where personal injury or death may occur. Should Buyer purchase or use SCILLC products for any such unintended or unauthorized application, Buyer shall indemnify and hold SCILLC and its officers, employees, subsidiaries, affiliates, and distributors harmless against all claims, costs, damages, and expenses, and reasonable attorney fees arising out of, directly or indirectly, any claim of personal injury or death associated with such unintended or unauthorized use, even if such claim alleges that SCILLC was negligent regarding the design or manufacture of the part. SCILLC is an Equal Opportunity/Affirmative Action Employer. This literature is subject to all applicable copyright laws and is not for resale in any manner.

## PUBLICATION ORDERING INFORMATION

### LITERATURE FULFILLMENT:

Literature Distribution Center for ON Semiconductor  
P.O. Box 5163, Denver, Colorado 80217 USA  
**Phone:** 303-675-2175 or 800-344-3860 Toll Free USA/Canada  
**Fax:** 303-675-2176 or 800-344-3867 Toll Free USA/Canada  
**Email:** [orderlit@onsemi.com](mailto:orderlit@onsemi.com)

**N. American Technical Support:** 800-282-9855 Toll Free  
USA/Canada  
**Europe, Middle East and Africa Technical Support:**  
Phone: 421 33 790 2910  
**Japan Customer Focus Center**  
Phone: 81-3-5817-1050

**ON Semiconductor Website:** [www.onsemi.com](http://www.onsemi.com)

**Order Literature:** <http://www.onsemi.com/orderlit>

For additional information, please contact your local Sales Representative