

BUH50G

Switch-mode NPN Silicon Planar Power Transistor

The BUH50G has an application specific state-of-art die designed for use in 50 W HALOGEN electronic transformers and switch-mode applications.

Features

- Improved Efficiency Due to Low Base Drive Requirements:
High and Flat DC Current Gain h_{FE}
Fast Switching
- ON Semiconductor Six Sigma Philosophy Provides Tight and Reproducible Parametric Distributions
- Specified Dynamic Saturation Data
- Full Characterization at 125°C
- These Devices are Pb-Free and are RoHS Compliant*

MAXIMUM RATINGS

Rating	Symbol	Value	Unit
Collector-Emitter Sustaining Voltage	V_{CEO}	500	Vdc
Collector-Base Breakdown Voltage	V_{CBO}	800	Vdc
Collector-Emitter Breakdown Voltage	V_{CES}	800	Vdc
Emitter-Base Voltage	V_{EBO}	9	Vdc
Collector Current – Continuous	I_C	4	Adc
Collector Current – Peak (Note 1)	I_{CM}	8	Adc
Base Current – Continuous	I_B	2	Adc
Base Current – Peak (Note 1)	I_{BM}	4	Adc
Total Device Dissipation @ $T_C = 25^\circ\text{C}$ Derate above 25°C	P_D	50 0.4	W W/°C
Operating and Storage Temperature	T_J, T_{stg}	-65 to 150	°C

Stresses exceeding those listed in the Maximum Ratings table may damage the device. If any of these limits are exceeded, device functionality should not be assumed, damage may occur and reliability may be affected.

1. Pulse Test: Pulse Width = 5 ms, Duty Cycle $\leq 10\%$.

THERMAL CHARACTERISTICS

Characteristics	Symbol	Max	Unit
Thermal Resistance, Junction-to-Case	$R_{\theta JC}$	2.5	°C/W
Thermal Resistance, Junction-to-Ambient	$R_{\theta JA}$	62.5	°C/W
Maximum Lead Temperature for Soldering Purposes 1/8" from Case for 5 Seconds	T_L	260	°C

*For additional information on our Pb-Free strategy and soldering details, please download the ON Semiconductor Soldering and Mounting Techniques Reference Manual, SOLDERRM/D.



ON Semiconductor®

www.onsemi.com

**POWER TRANSISTOR
4 AMPERES
800 VOLTS, 50 WATTS**

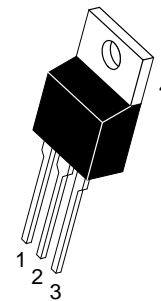
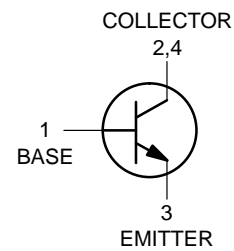

TO-220
CASE 221A
STYLE 1

MARKING DIAGRAM



BUH50 = Device Code
A = Assembly Location
Y = Year
WW = Work Week
G = Pb-Free Package

ORDERING INFORMATION

Device	Package	Shipping
BUH50G	TO-220 (Pb-Free)	50 Units / Rail

BUH50G

ELECTRICAL CHARACTERISTICS (T_C = 25°C unless otherwise noted)

Characteristic	Symbol	Min	Typ	Max	Unit
----------------	--------	-----	-----	-----	------

OFF CHARACTERISTICS

Collector-Emitter Sustaining Voltage (I _C = 100 mA, L = 25 mH)	V _{CEO(sus)}	500			Vdc
Collector Cutoff Current (V _{CE} = Rated V _{CEO} , I _B = 0)	I _{CEO}			100	μAdc
Collector Cutoff Current @ T _C = 25°C (V _{CE} = Rated V _{CES} , V _{EB} = 0) @ T _C = 125°C	I _{CES}			100 1000	μAdc
Emitter-Cutoff Current (V _{EB} = 9 Vdc, I _C = 0)	I _{EBO}			100	μAdc

ON CHARACTERISTICS

Base-Emitter Saturation Voltage (I _C = 1 Adc, I _B = 0.33 Adc) (I _C = 2 Adc, I _B = 0.66 Adc) 25°C (I _C = 2 Adc, I _B = 0.66 Adc) 100°C	V _{BE(sat)}		0.86 0.94 0.85	1.2 1.6 1.5	Vdc
Collector-Emitter Saturation Voltage (I _C = 1 Adc, I _B = 0.33 Adc) (I _C = 2 Adc, I _B = 0.66 Adc) (I _C = 3 Adc, I _B = 1 Adc)	V _{CE(sat)}	@ T _C = 25°C @ T _C = 25°C @ T _C = 125°C @ T _C = 25°C	0.2 0.32 0.29 0.5	0.5 0.6 0.7 1	Vdc
DC Current Gain (I _C = 1 Adc, V _{CE} = 5 Vdc) (I _C = 2 Adc, V _{CE} = 5 Vdc)	h _{FE}	@ T _C = 25°C @ T _C = 25°C	7 5	13 10	- -

DYNAMIC CHARACTERISTICS

Current Gain Bandwidth (I _C = 0.5 Adc, V _{CE} = 10 Vdc, f = 1 MHz)	f _T	4			MHz
Output Capacitance (V _{CB} = 10 Vdc, I _E = 0, f = 1 MHz)	C _{ob}		50	100	pF
Input Capacitance (V _{EB} = 8 Vdc)	C _{ib}		850	1200	pF

DYNAMIC SATURATION VOLTAGE

Dynamic Saturation Voltage: Determined 1 μs and 3 μs respectively after rising I _{B1} reaches 90% of final I _{B1}	I _C = 1 A I _{B1} = 0.33 A V _{CC} = 300 V	@ 1 μs	@ T _C = 25°C @ T _C = 125°C	V _{CE(dsat)}	1.75 5		V
		@ 3 μs	@ T _C = 25°C @ T _C = 125°C		0.3 0.5		V
	I _C = 2 A I _{B1} = 0.66 A V _{CC} = 300 V	@ 1 μs	@ T _C = 25°C @ T _C = 125°C		6 14		V
		@ 3 μs	@ T _C = 25°C @ T _C = 125°C		0.75 4		V

SWITCHING CHARACTERISTICS: Resistive Load (D.C. ≤ 10%, Pulse Width = 20 μs)

Turn-on Time	I _C = 2 Adc, I _{B1} = 0.4 Adc I _{B2} = 0.4 Adc V _{CC} = 125 Vdc	@ T _C = 25°C	t _{on}	95	250	ns
Turn-off Time		@ T _C = 25°C	t _{off}	2.5	3.5	μs
Turn-on Time	I _C = 2 Adc, I _{B1} = 0.4 Adc I _{B2} = 1 Adc V _{CC} = 125 Vdc	@ T _C = 25°C	t _{on}	110	250	ns
Turn-off Time		@ T _C = 25°C	t _{off}	0.95	2	μs
Turn-on Time	I _C = 1 Adc, I _{B1} = 0.3 Adc I _{B2} = 0.3 Adc V _{CC} = 125 Vdc	@ T _C = 25°C	t _{on}	100	200	ns
Turn-off Time		@ T _C = 25°C	t _{off}	2.9	3.5	μs

SWITCHING CHARACTERISTICS: Inductive Load (V_{clamp} = 300 V, V_{CC} = 15 V, L = 200 μH)

Fall Time	I _C = 2 Adc I _{B1} = 0.4 Adc I _{B2} = 1 Adc	@ T _C = 25°C @ T _C = 125°C	t _f	80 95	150	ns
Storage Time		@ T _C = 25°C @ T _C = 125°C	t _s	1.2 1.7	2.5	μs
Crossover Time		@ T _C = 25°C @ T _C = 125°C	t _c	150 180	300	ns
Fall Time	I _C = 2 Adc I _{B1} = 0.66 Adc I _{B2} = 1 Adc	@ T _C = 25°C @ T _C = 125°C	t _f	90 100	150	ns
Storage Time		@ T _C = 25°C @ T _C = 125°C	t _s	1.7 2.5	2.75	μs
Crossover Time		@ T _C = 25°C @ T _C = 125°C	t _c	190 220	350	ns

Product parametric performance is indicated in the Electrical Characteristics for the listed test conditions, unless otherwise noted. Product performance may not be indicated by the Electrical Characteristics if operated under different conditions.

TYPICAL STATIC CHARACTERISTICS

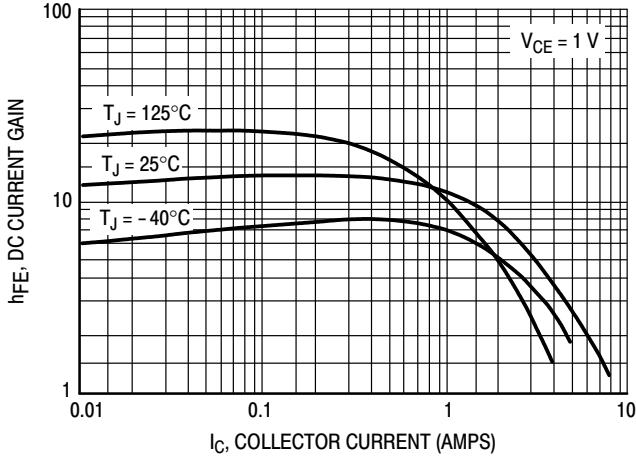

Figure 1. DC Current Gain @ 1 Volt

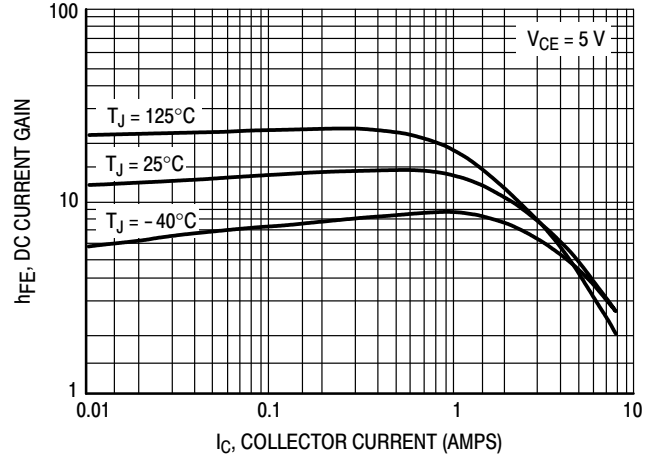

Figure 2. DC Current Gain @ 5 Volt

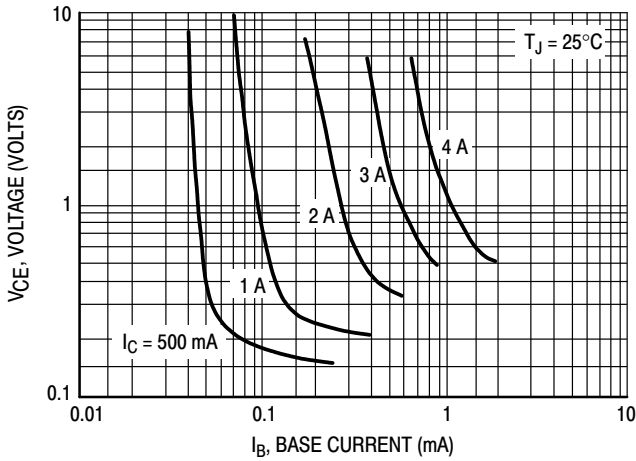

Figure 3. Collector Saturation Region

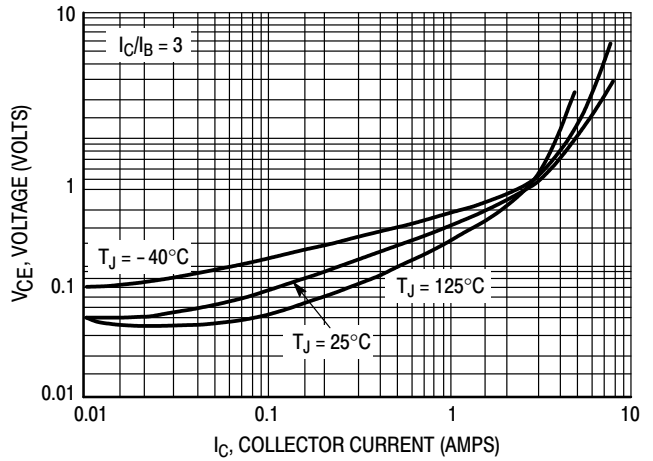

Figure 4. Collector-Emitter Saturation Voltage

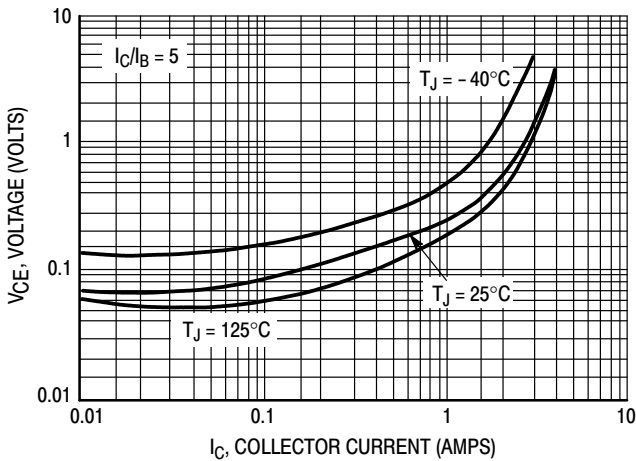

Figure 5. Collector-Emitter Saturation Voltage

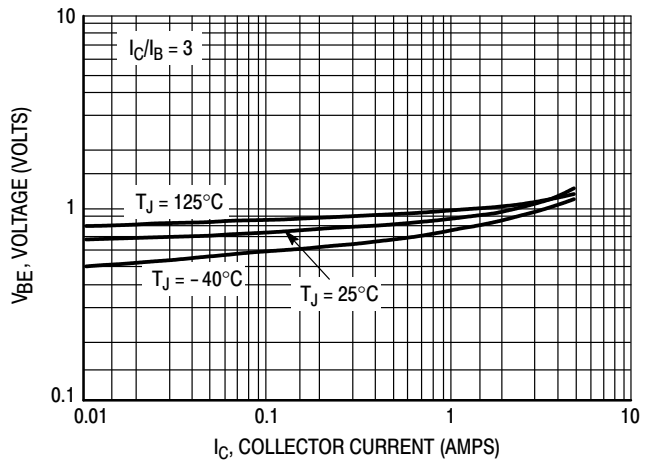

Figure 6. Base-Emitter Saturation Region

BUH50G

TYPICAL STATIC CHARACTERISTICS

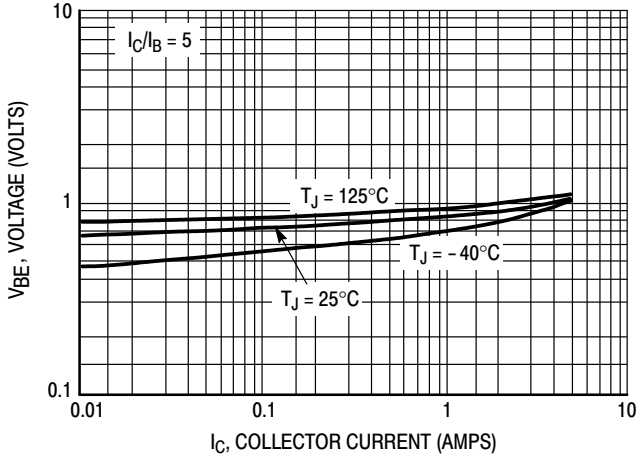

Figure 7. Base-Emitter Saturation Region

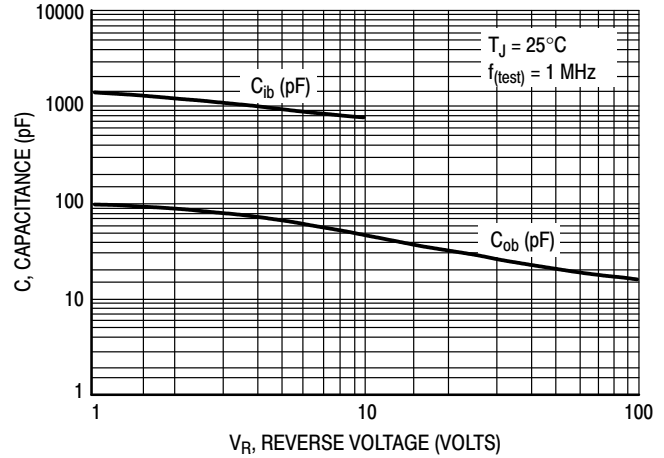

Figure 8. Capacitance

TYPICAL SWITCHING CHARACTERISTICS

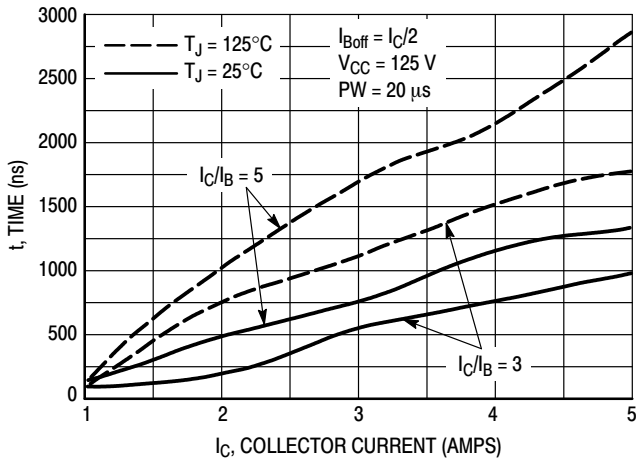

Figure 9. Resistive Switching, t_{on}

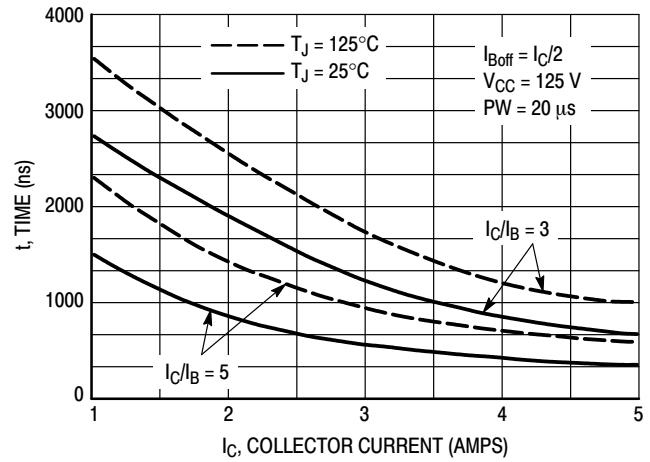

Figure 10. Resistive Switch Time, t_{off}

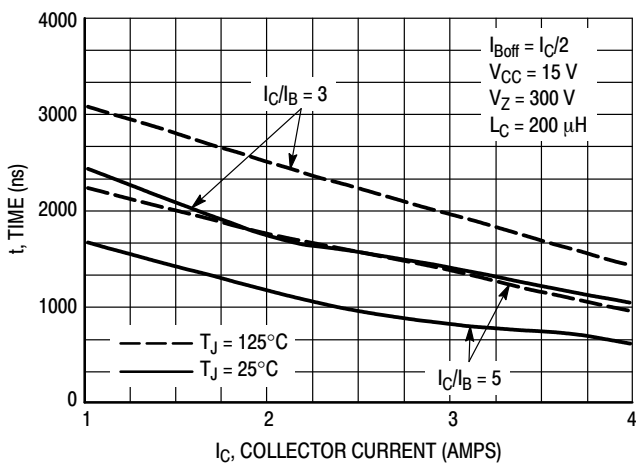

Figure 11. Inductive Storage Time, t_{si}

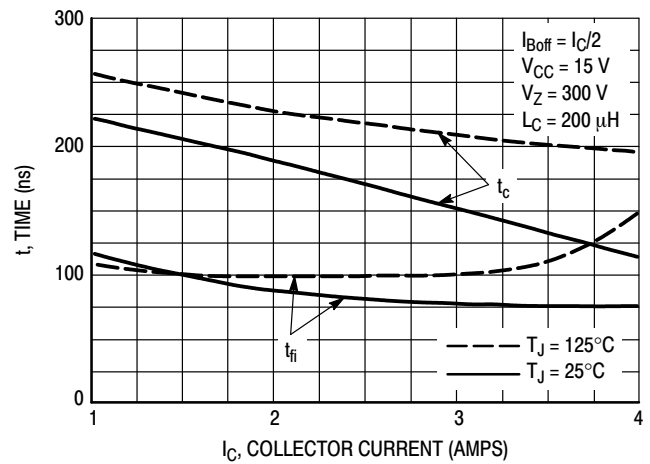

Figure 12. Inductive Storage Time, t_c & t_{fi} @ $I_C/I_B = 3$

BUH50G

TYPICAL CHARACTERISTICS

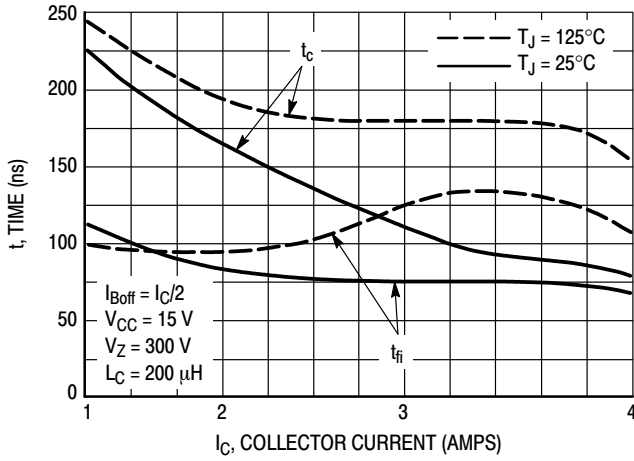

Figure 13. Inductive Switching, t_c & t_{fi} @ $I_C/I_B = 5$

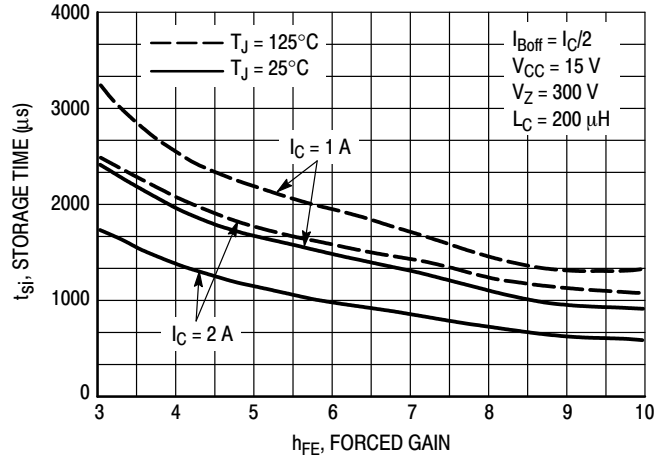

Figure 14. Inductive Storage Time

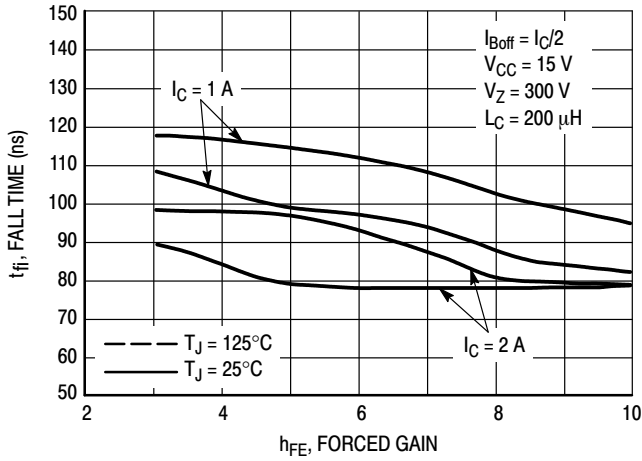

Figure 15. Inductive Fall Time

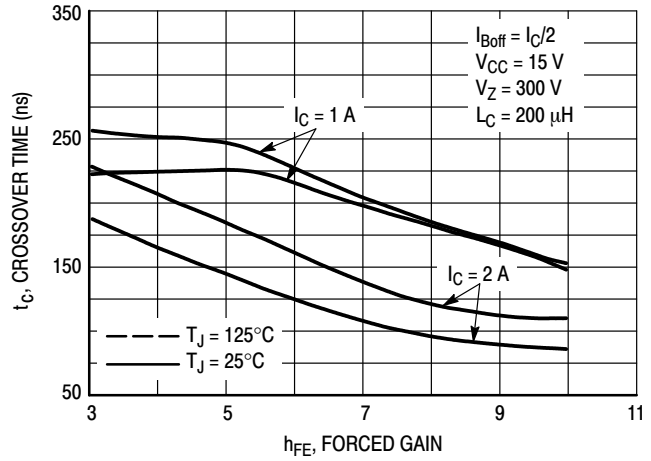

Figure 16. Inductive Crossover Time

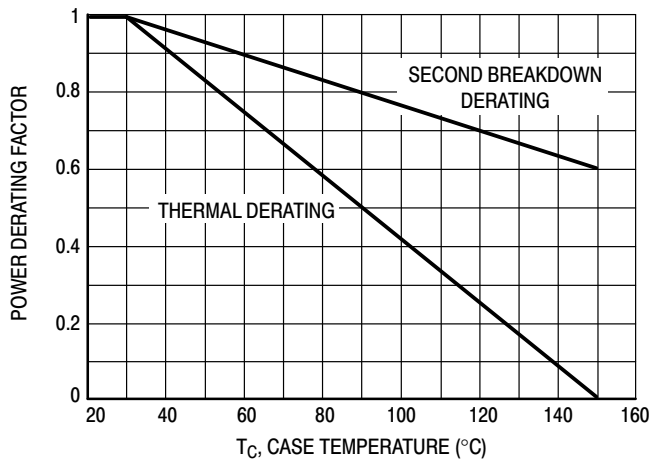

Figure 17. Forward Power Derating

BUH50G

There are two limitations on the power handling ability of a transistor: average junction temperature and second breakdown. Safe operating area curves indicate I_C - V_{CE} limits of the transistor that must be observed for reliable operation; i.e., the transistor must not be subjected to greater dissipation than the curves indicate. The data of Figure 20 is based on $T_C = 25^\circ\text{C}$; $T_{J(pk)}$ is variable depending on power level. Second breakdown pulse limits are valid for duty cycles to 10% but must be de-rated when $T_C > 25^\circ\text{C}$. Second breakdown limitations do not de-rate the same as thermal limitations. Allowable current at the voltages shown on Figure 20 may be found at any case temperature by using the appropriate curve on Figure 17.

$T_{J(pk)}$ may be calculated from the data in Figure 22. At any case temperatures, thermal limitations will reduce the power that can be handled to values less than the limitations imposed by second breakdown. For inductive loads, high voltage and current must be sustained simultaneously during turn-off with the base to emitter junction reverse biased. The safe level is specified as a reverse biased safe operating area (Figure 21). This rating is verified under clamped conditions so that the device is never subjected to an avalanche mode.

TYPICAL CHARACTERISTICS

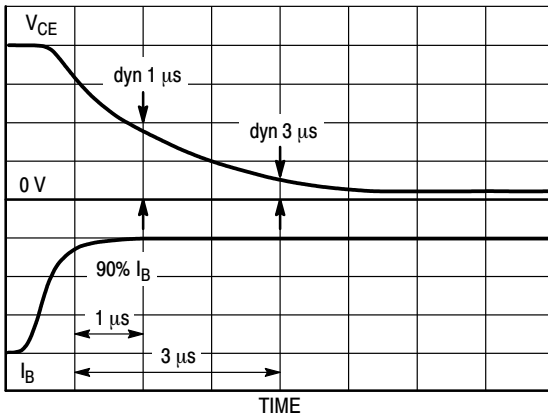

Figure 18. Dynamic Saturation Voltage

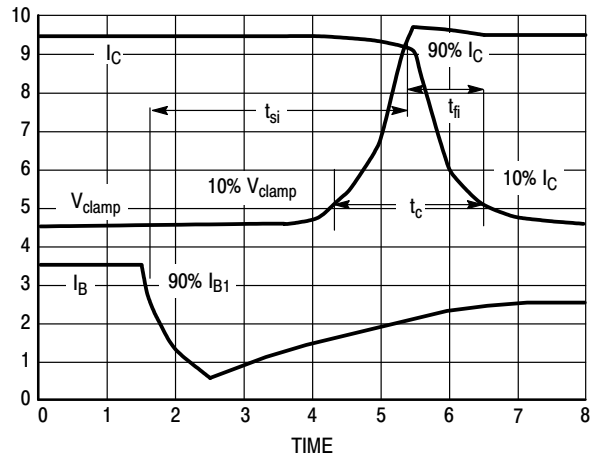

Figure 19. Inductive Switching Measurements

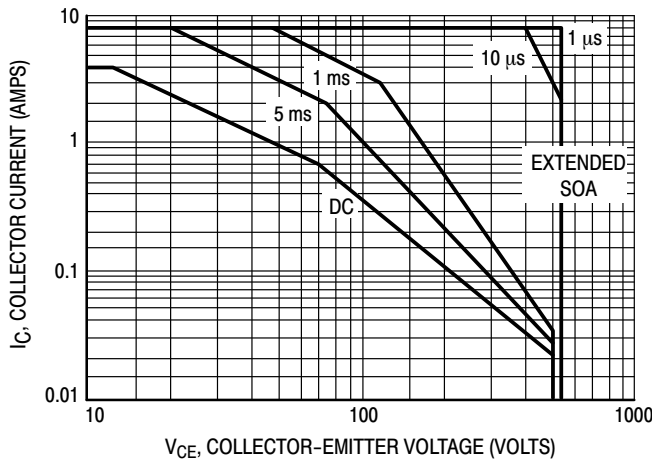

Figure 20. Forward Bias Safe Operating Area

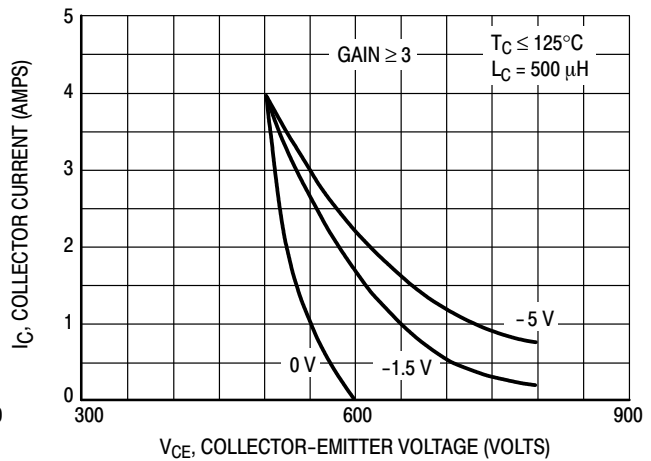
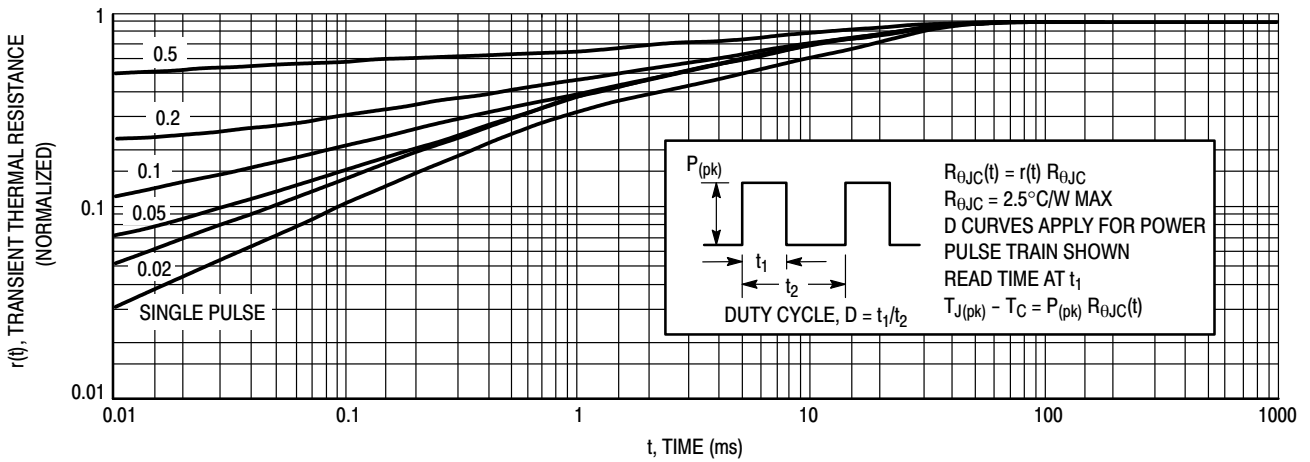
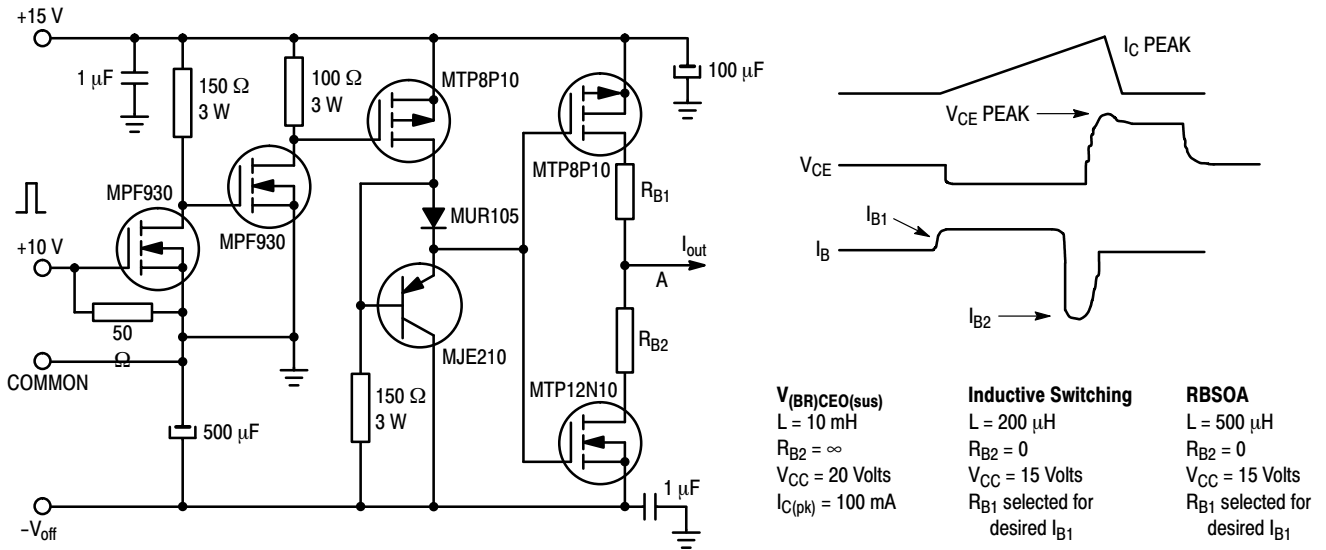

Figure 21. Reverse Bias Safe Operating Area

BUH50G

TYPICAL CHARACTERISTICS

Table 1. Inductive Load Switching Drive Circuit



onsemi, **Onsemi**, and other names, marks, and brands are registered and/or common law trademarks of Semiconductor Components Industries, LLC dba "**onsemi**" or its affiliates and/or subsidiaries in the United States and/or other countries. **onsemi** owns the rights to a number of patents, trademarks, copyrights, trade secrets, and other intellectual property. A listing of **onsemi**'s product/patent coverage may be accessed at www.onsemi.com/site/pdf/Patent-Marking.pdf. **onsemi** reserves the right to make changes at any time to any products or information herein, without notice. The information herein is provided "as-is" and **onsemi** makes no warranty, representation or guarantee regarding the accuracy of the information, product features, availability, functionality, or suitability of its products for any particular purpose, nor does **onsemi** assume any liability arising out of the application or use of any product or circuit, and specifically disclaims any and all liability, including without limitation special, consequential or incidental damages. Buyer is responsible for its products and applications using **onsemi** products, including compliance with all laws, regulations and safety requirements or standards, regardless of any support or applications information provided by **onsemi**. "Typical" parameters which may be provided in **onsemi** data sheets and/or specifications can and do vary in different applications and actual performance may vary over time. All operating parameters, including "Typicals" must be validated for each customer application by customer's technical experts. **onsemi** does not convey any license under any of its intellectual property rights nor the rights of others. **onsemi** products are not designed, intended, or authorized for use as a critical component in life support systems or any FDA Class 3 medical devices or medical devices with a same or similar classification in a foreign jurisdiction or any devices intended for implantation in the human body. Should Buyer purchase or use **onsemi** products for any such unintended or unauthorized application, Buyer shall indemnify and hold **onsemi** and its officers, employees, subsidiaries, affiliates, and distributors harmless against all claims, costs, damages, and expenses, and reasonable attorney fees arising out of, directly or indirectly, any claim of personal injury or death associated with such unintended or unauthorized use, even if such claim alleges that **onsemi** was negligent regarding the design or manufacture of the part. **onsemi** is an Equal Opportunity/Affirmative Action Employer. This literature is subject to all applicable copyright laws and is not for resale in any manner.

ADDITIONAL INFORMATION

TECHNICAL PUBLICATIONS:

Technical Library: www.onsemi.com/design/resources/technical-documentation
onsemi Website: www.onsemi.com

ONLINE SUPPORT: www.onsemi.com/support

For additional information, please contact your local Sales Representative at www.onsemi.com/support/sales