

Schematic for the AR0134CSSC00SUEAH3-GEVB Evaluation Board

Block Diagram

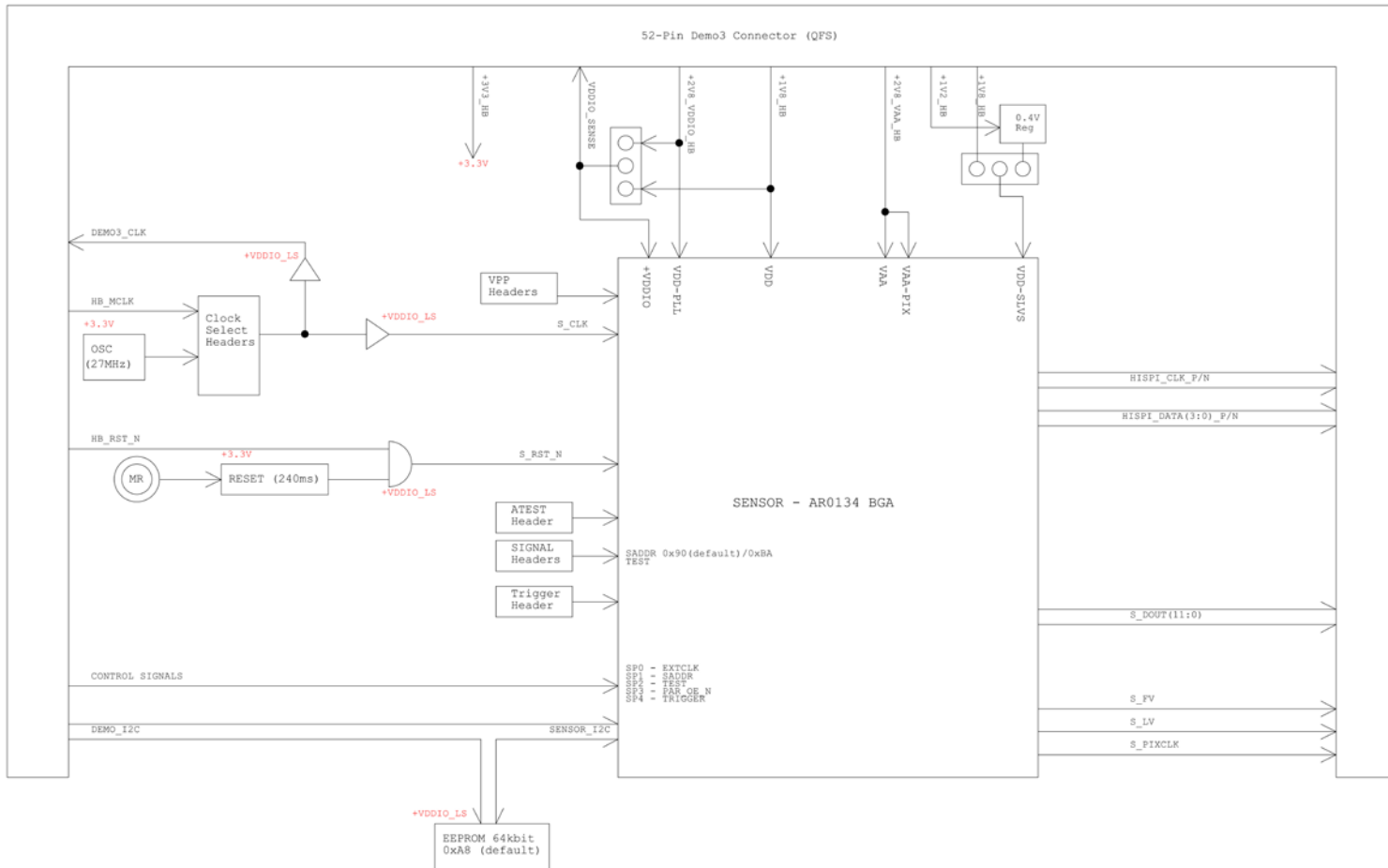

Sensor

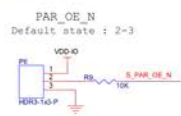
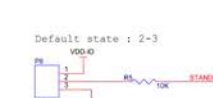
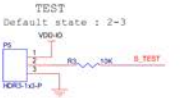
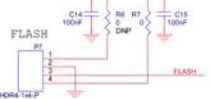
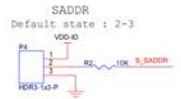
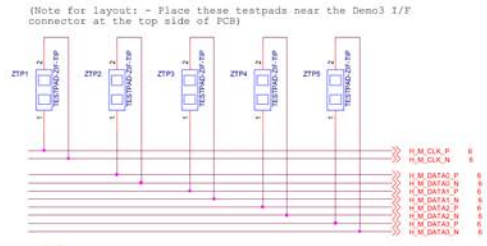
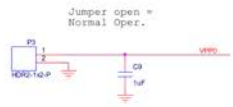
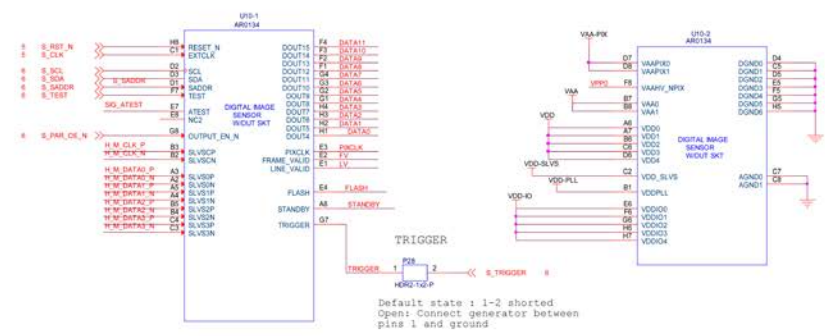

Debug Headers: Cut away the shorted trace and mount header for power debugging

VDD 1.8V SUPPLY



VDD-SLVS 1.8V SUPPLY

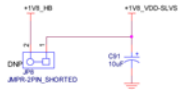

VDD-PLL 2.8V SUPPLY

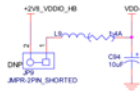

VAA 2.8V SUPPLY

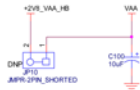

VAA-PIX 2.8V SUPPLY

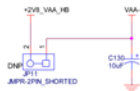

Power

PERIPHERAL 5V SUPPLY

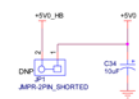

PERIPHERAL 3.3V SUPPLY

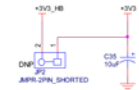

VDDIO & VDDIO LS 1.8V/2.8V SUPPLY

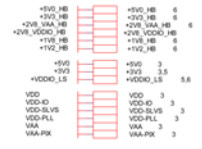
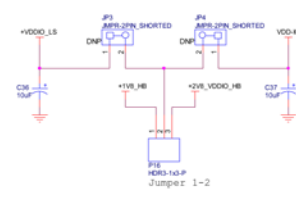

5V LED

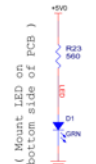

VDDSLVSPHY 0.4V SUPPLY

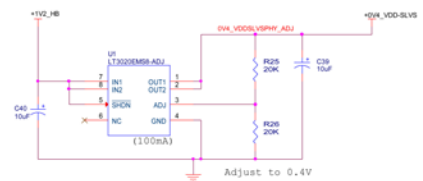

Selection of 0.4V or 1.2V/1V8 for VDDSLVSPHY supply

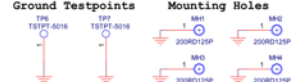
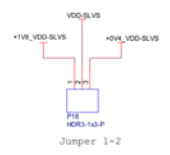

Clock and Reset

+5V0	3.4
+3V3	3.4
+VDDIO_LS	4.6

CLOCK CIRCUIT

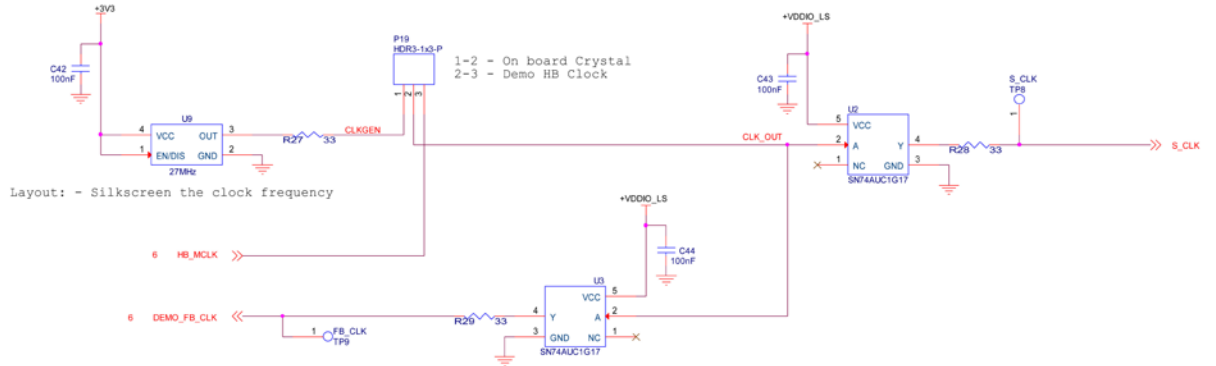

RESET CIRCUIT

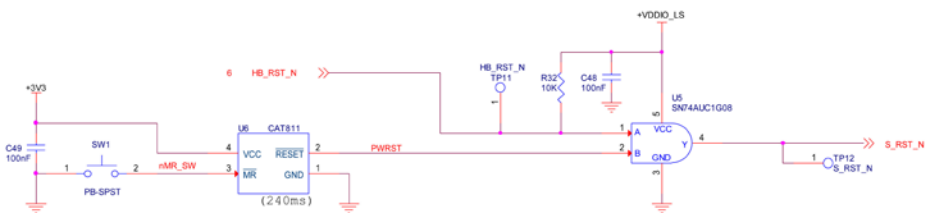

External Interface

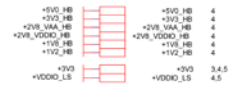

DEMO3 BASEBOARD I/F

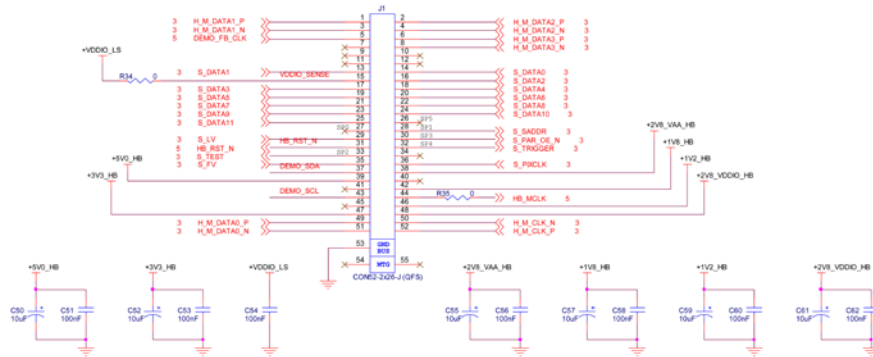

I2C DEBUG

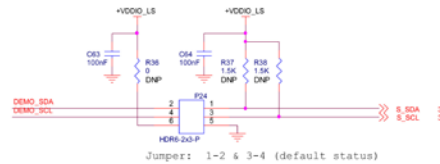

LENS CORRECTION EEPROM

