



Is Now Part of



ON Semiconductor®

To learn more about ON Semiconductor, please visit our website at
www.onsemi.com

ON Semiconductor and the ON Semiconductor logo are trademarks of Semiconductor Components Industries, LLC dba ON Semiconductor or its subsidiaries in the United States and/or other countries. ON Semiconductor owns the rights to a number of patents, trademarks, copyrights, trade secrets, and other intellectual property. A listing of ON Semiconductor's product/patent coverage may be accessed at www.onsemi.com/site/pdf/Patent-Marking.pdf. ON Semiconductor reserves the right to make changes without further notice to any products herein. ON Semiconductor makes no warranty, representation or guarantee regarding the suitability of its products for any particular purpose, nor does ON Semiconductor assume any liability arising out of the application or use of any product or circuit, and specifically disclaims any and all liability, including without limitation special, consequential or incidental damages. Buyer is responsible for its products and applications using ON Semiconductor products, including compliance with all laws, regulations and safety requirements or standards, regardless of any support or applications information provided by ON Semiconductor. "Typical" parameters which may be provided in ON Semiconductor data sheets and/or specifications can and do vary in different applications and actual performance may vary over time. All operating parameters, including "Typicals" must be validated for each customer application by customer's technical experts. ON Semiconductor does not convey any license under its patent rights nor the rights of others. ON Semiconductor products are not designed, intended, or authorized for use as a critical component in life support systems or any FDA Class 3 medical devices or medical devices with a same or similar classification in a foreign jurisdiction or any devices intended for implantation in the human body. Should Buyer purchase or use ON Semiconductor products for any such unintended or unauthorized application, Buyer shall indemnify and hold ON Semiconductor and its officers, employees, subsidiaries, affiliates, and distributors harmless against all claims, costs, damages, and expenses, and reasonable attorney fees arising out of, directly or indirectly, any claim of personal injury or death associated with such unintended or unauthorized use, even if such claim alleges that ON Semiconductor was negligent regarding the design or manufacture of the part. ON Semiconductor is an Equal Opportunity/Affirmative Action Employer. This literature is subject to all applicable copyright laws and is not for resale in any manner.



User Guide for
FEBFSB127H_T001
Evaluation Board

FSB127H 100 kHz Power Switch for
ATX Standby 16 W

Featured Fairchild Product:
FSB127H

***Direct questions or comments
about this Evaluation Board to:
“Worldwide Direct Support”***

Fairchild Semiconductor.com

Table of Contents

1. Overview.....	3
2. Board Configuration	3
3. Schematic.....	4
4. PCB Layout.....	5
5. Test Results.....	6
5.1. Brown-in / Brownout.....	6
5.2. AC Trim Up and Trim Down.....	6
5.3. Line and Load Regulation	6
5.4. DC Output Rise Time.....	7
5.5. DC Transient Response	8
5.6. Ripple and Noise	8
5.7. Capacitive Load.....	9
5.8. Power Saving.....	10
5.9. Efficiency	10
5.10. Short-Circuit Protection	11
5.11. X-Cap Discharge	11
5.12. Over-Power Protection	12
5.13. Surge and ESD	12
5.14. EMI Conduction.....	12
6. Bill of Materials	13
7. Transformer.....	14
7.1. Transformer Specification.....	14
8. Revision History	15

3. Schematic

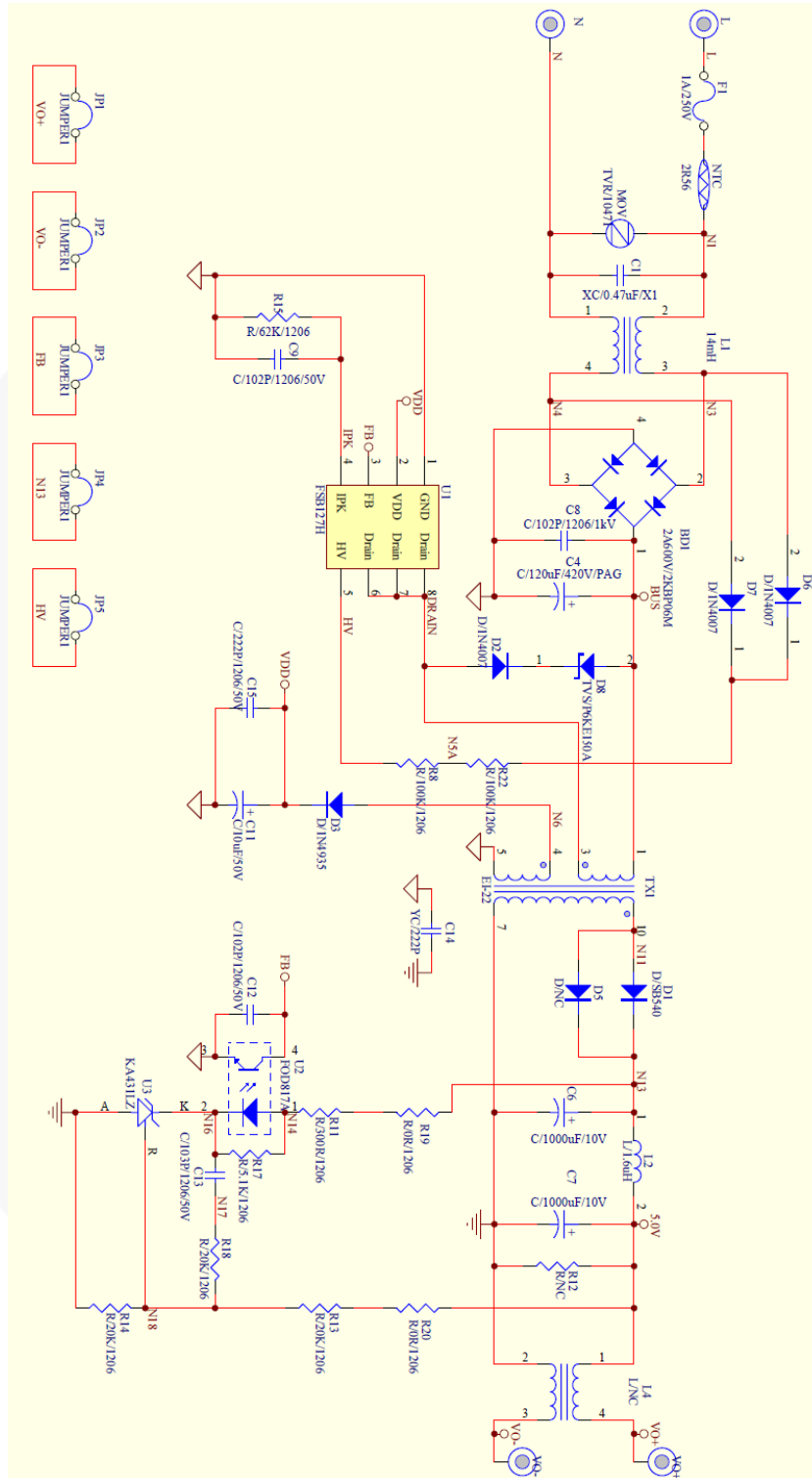

Figure 2. Evaluation Board Schematic

4. PCB Layout

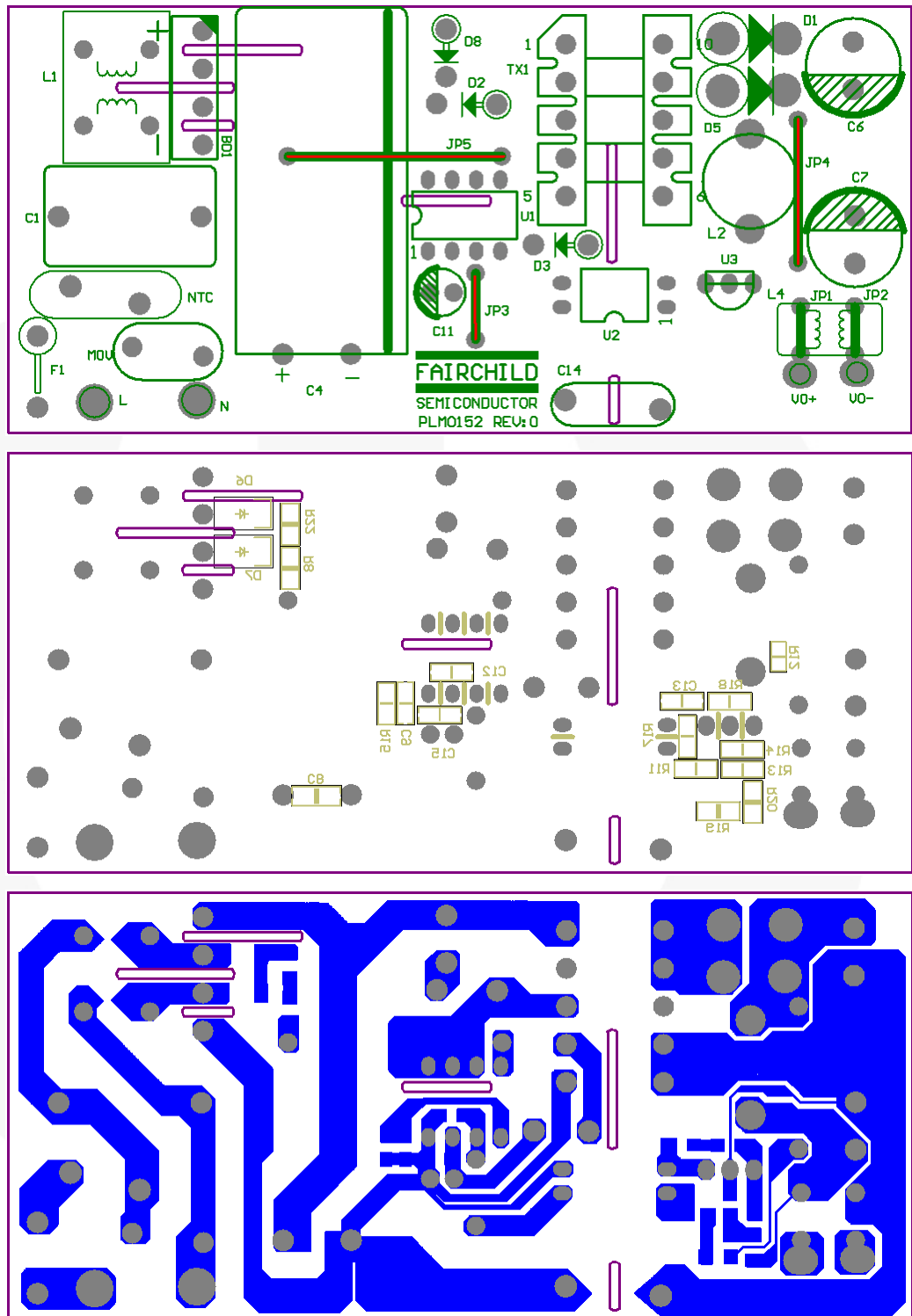

Figure 3. Evaluation Board PCB Layout

5. Test Results

5.1. Brown-in / Brownout

5.1.1. Test Condition

Decrease input AC voltage gradually and measure the turn-off threshold.

After AC power off, increase input voltage and measure the recovery threshold.

5.1.2. Test Result

$R_{HV}=200\text{ k}\Omega$	Minimum Load	Maximum Load
Turn off	70 V _{AC}	68 V _{AC}
Turn on	81 V _{AC}	81 V _{AC}

5.2. AC Trim Up and Trim Down

5.2.1. Test Condition

Switch the input voltage from 90 V_{AC} to 264 V_{AC} or from 264 V_{AC} to 90 V_{AC}; the output voltages should be normal.

5.2.2. Test Result

	Minimum Load	Maximum Load
90 V _{AC} → 264 V _{AC}	Pass	Pass
264 V _{AC} → 90 V _{AC}	Pass	Pass

5.3. Line and Load Regulation

5.3.1. Test Condition

Line regulation: 1% maximum.

Load regulation: 5% maximum.

5.3.2. Test Result

Input Voltage	Max. Load	Min. Load	Load Regulation (%)
90 V _{AC} / 60 Hz	4.971 V	5.013 V	0.84%
264 V _{AC} / 50 Hz	4.988 V	5.013 V	
Line Regulation (%)	0.34%	0%	

5.4. DC Output Rise Time

5.4.1. Test Condition

Load: maximum load and minimum load. DC-output rise time: 20 ms, maximum.

5.4.2. Measured Waveforms

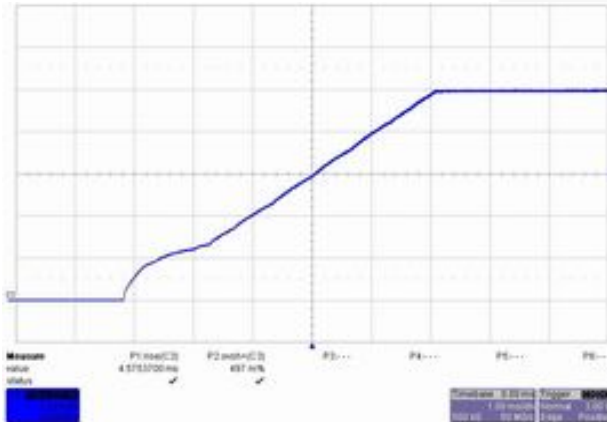

Figure 4. 90 V_{AC} / 60 Hz Maximum Load

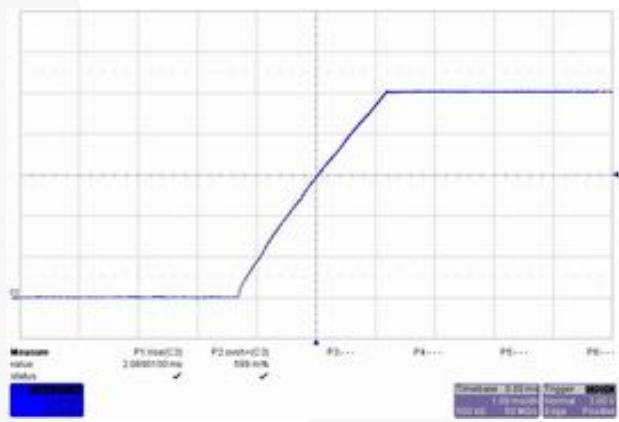

Figure 5. 90 V_{AC} / 60 Hz Minimum Load

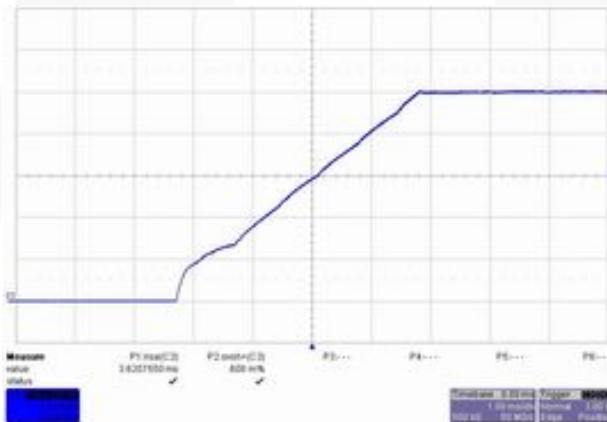

Figure 6. 264 V_{AC} / 50 Hz Maximum Load

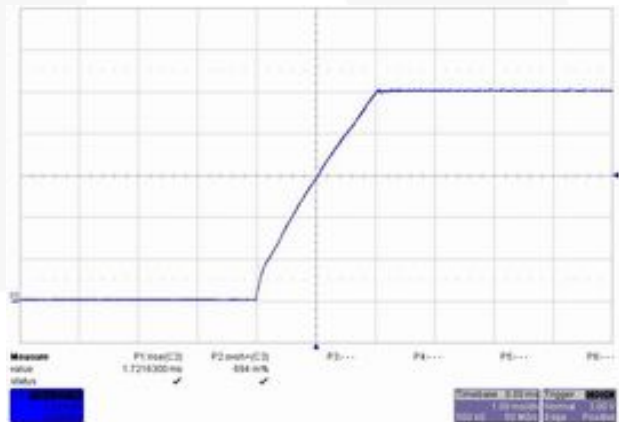

Figure 7. 264 V_{AC} / 50 Hz Minimum Load

5.5. DC Transient Response

5.5.1. Test Condition

From 10% to 90% of the maximum load, with a 2.5 A/ μ s slew rate. Output load frequency is 100 Hz with 50% duty cycle.

5.5.2. Measured Waveforms

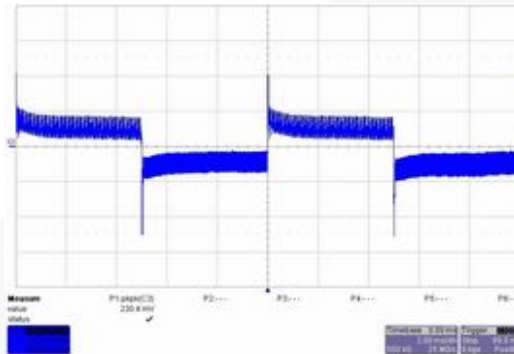

Figure 8. 90 V_{AC} / 60 Hz

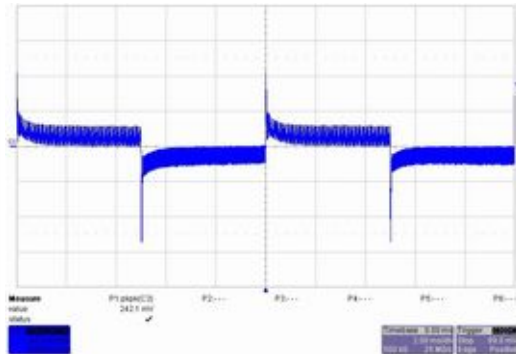

Figure 9. 264 V_{AC} / 50 Hz

5.6. Ripple and Noise

5.6.1. Test Condition

Ripple and noise are measured using a 20 MHz bandwidth-limited oscilloscope with a 10 μ F electrolytic capacitor paralleled with a high-frequency 0.1 μ F ceramic across each output.

5.6.2. Measured Waveform

Ripple and noise are measured using a 20 MHz bandwidth-limited oscilloscope with a 10 μ F electrolytic capacitor paralleled with a high-frequency 0.1 μ F ceramic across each output.

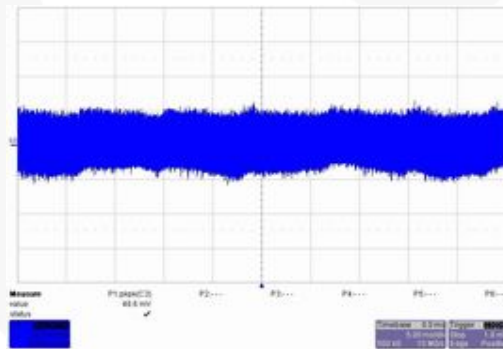

Figure 10. 90 V_{AC} / 60 Hz Maximum Load

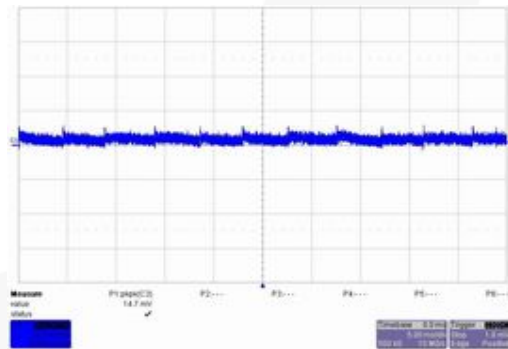

Figure 11. 90 V_{AC} / 60 Hz Minimum Load

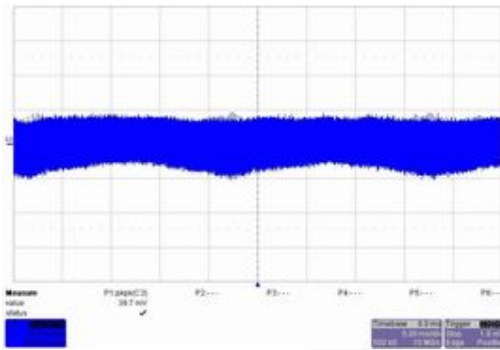

Figure 12. 264 V_{AC} / 50 Hz Maximum Load

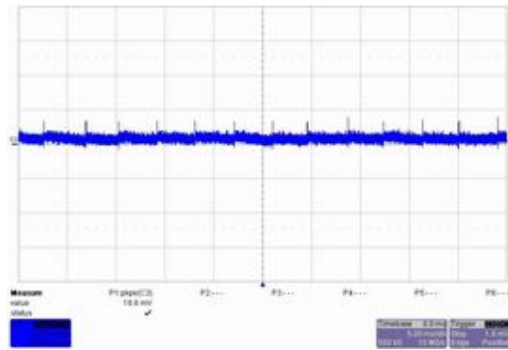

Figure 13. 264 V_{AC} / 50 Hz Minimum Load

5.7. Capacitive Load

5.7.1. Test Condition

Output Capacitive Load = 12000 μF

5.7.2. Measured Waveforms

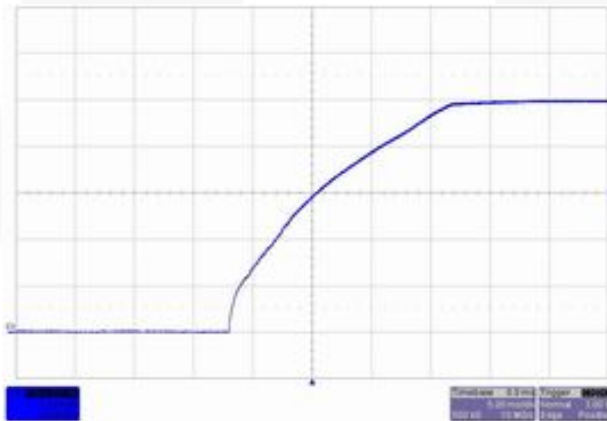

90 V_{AC} / 60 Hz Maximum Load

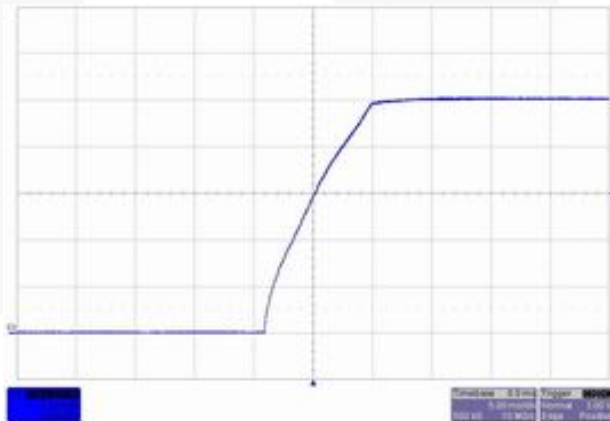

90 V_{AC} / 60 Hz Minimum Load

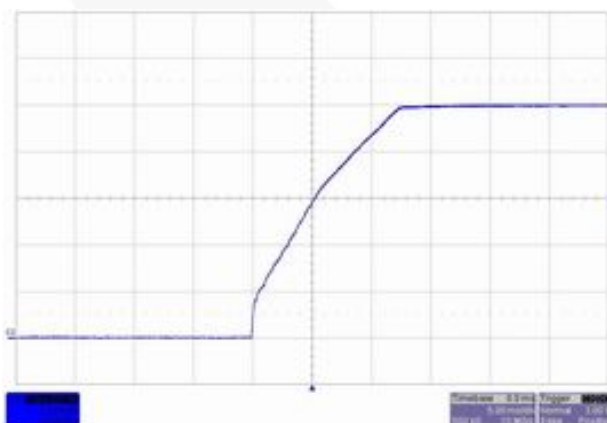

264 V_{AC} / 50 Hz Maximum Load

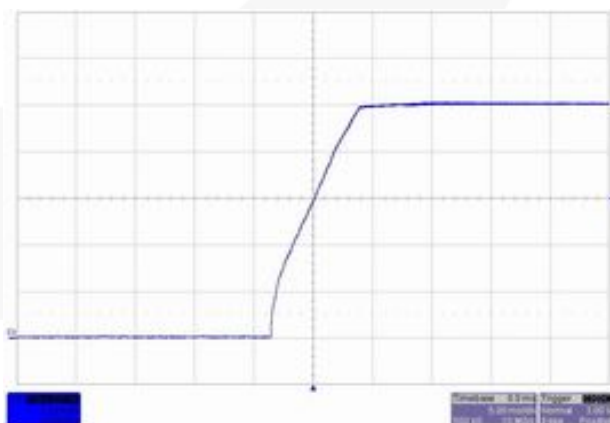

264 V_{AC} / 50 Hz Minimum Load

5.8. Power Saving

5.8.1. Test Condition

The input wattage is < 1 W in Standby Mode with 0.5 W loading for 2010 EuP.

The input wattage is < 0.5 W in Standby Mode with 0.25 W loading for 2013 EuP.

5.8.2. Test Result

FSB127H		Input Watts	Output Watts
A.	When V_{IN} = 230 V _{AC} , with 0.5 W Loading	0.713 W	0.5 W
	When V_{IN} = 240 V _{AC} , with 0.5 W Loading	0.715 W	0.5 W
	When V_{IN} = 264 V _{AC} , with 0.5 W Loading	0.733 W	0.5 W
B.	When V_{IN} = 230 V _{AC} , with 0.25 W Loading	0.384 W	0.25 W
	When V_{IN} = 240 V _{AC} , with 0.25 W Loading	0.389 W	0.25 W
	When V_{IN} = 264 V _{AC} , with 0.25 W Loading	0.406 W	0.25 W
C.	When V_{IN} = 230 V _{AC} , with No Loading	53 mW	x
	When V_{IN} = 240 V _{AC} , with No Loading	56 mW	x
	When V_{IN} = 264 V _{AC} , with No Loading	68 mW	x

5.9. Efficiency

5.9.1. Test Condition

Measure efficiency at minimum, mid-point, and maximum loading.

5.9.2. Test Result

FSB127H	Input Watts	Output Watts	Efficiency
When V_{IN} = 115 V _{AC} , at 100% Load	20.62 W	16 W	81.17%
When V_{IN} = 115 V _{AC} , at 75% Load	15.28 W	12 W	82.42%
When V_{IN} = 115 V _{AC} , at 50% Load	10.02 W	8 W	82.51%
When V_{IN} = 115 V _{AC} , at 25% Load	5.07 W	4 W	81.70%
When V_{IN} = 230 V _{AC} , at 100% Load	20.78 W	16 W	81.40%
When V_{IN} = 230 V _{AC} , at 75% Load	15.11 W	12 W	82.24%
When V_{IN} = 230 V _{AC} , at 50% Load	10.15 W	8 W	80.45%
When V_{IN} = 230 V _{AC} , at 25% Load	5.18 W	4 W	78.62%

5.10. Short-Circuit Protection

5.10.1. Test Condition

In the event of a short circuit on any DC output, the power supply should be protected from damage.

5.10.2. Test Result

	90 V _{AC} / 60 Hz	264 V _{AC} / 50 Hz
Minimum Load	PASS	PASS
Maximum Load	PASS	PASS

5.10.3. Measured Waveforms

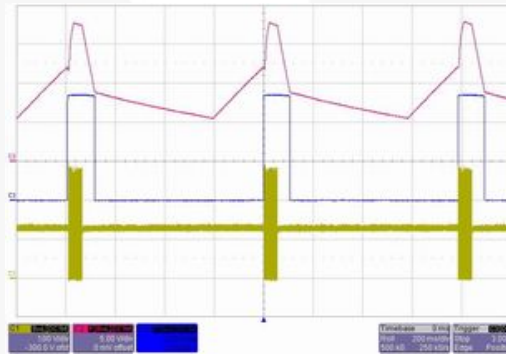

Figure 14. 90 V_{AC}/60 Hz, Output Short
(Ch1: Drain, Ch2: V_{DD}, Ch3: FB)

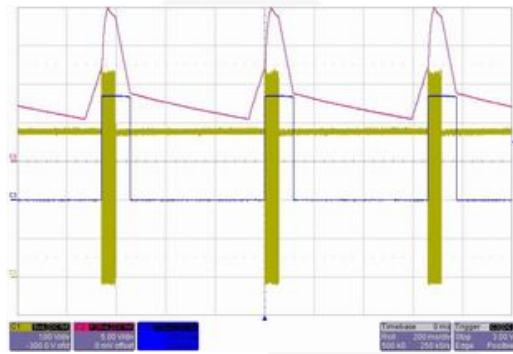

Figure 15. 264 V_{AC}/50 Hz Output Short
(Ch1: Drain, Ch2: V_{DD}, Ch3: FB)

5.11. X-Cap Discharge

5.11.1. Test Condition

The X-capacitor voltage should decay to less than 37% of its original peak value in one second after the AC input is disconnected.

5.11.2. Measured Waveforms

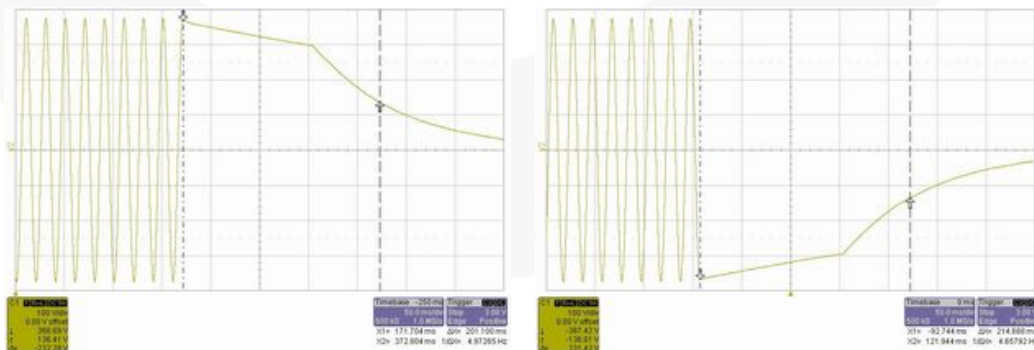

Figure 16. 264 V_{AC} / 50 Hz, No Load, X-Cap=0.47 μF, R_{HV}=200 kΩ

5.12. Over-Power Protection

5.12.1. Test Condition

An over-current from the output return line does not damage the power supply and the OLP protection is enabled.

5.12.2. Test Result

Input Voltage	90 V _{AC}	115 V _{AC}	132 V _{AC}	180 V _{AC}	230 V _{AC}	264 V _{AC}
OPP (W)	24.10 W	25.43 W	26.42 W	26.37 W	26.04 W	26.12 W

5.13. Surge and ESD

5.13.1. Test Result

L-PE ±6 kV	N-PE ±6 kV	L-N ±1 kV	AIR ±16 kV	Contact ±8 kV
Pass	Pass	Pass	Pass	Pass

5.14. EMI Conduction

5.14.1. Measured Waveforms

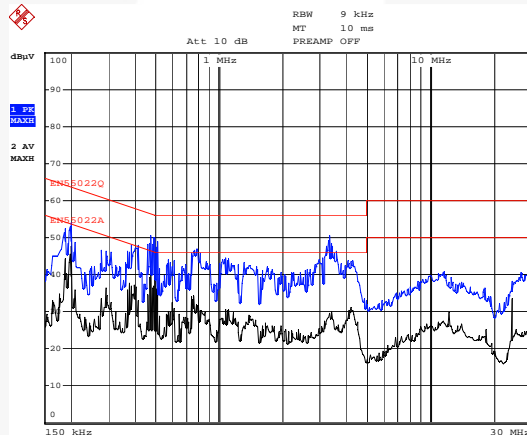

Figure 17. L: 115 V_{AC} / 60 Hz

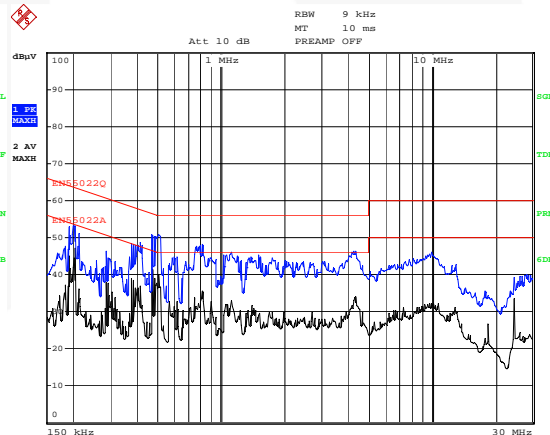

Figure 18. N: 115 V_{AC} / 60 Hz

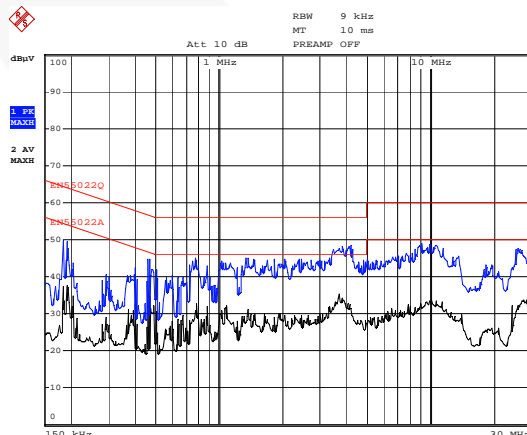

Figure 19. L: 230 V_{AC} / 50 Hz

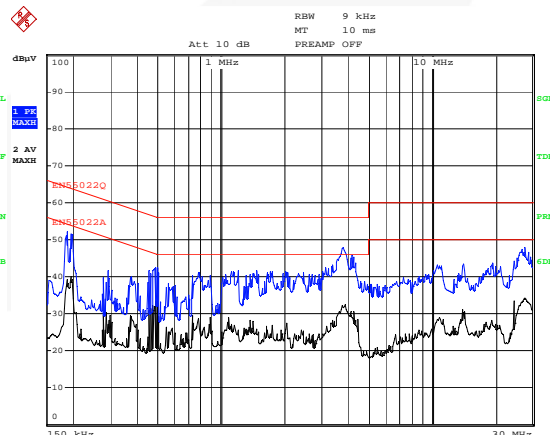

Figure 20. N: 230 V_{AC} / 50 Hz

6. Bill of Materials

Component	Qty	Part No.	Manufacturer	Reference
JUMPER WIRE 0.8Ø (mm)	5			JP1, JP2, JP3, JP4, JP5
Resistor 1206 0 Ω ±5%	2			R19, R20
Resistor 1206 100 kΩ ±5%	2			R8, R22
Resistor 1206 20 kΩ ±1%	3			R13, R14, R18
Resistor 1206 300 Ω ±5%	1			R11
Resistor 1206 51 kΩ ±5%	1			R17
Resistor 1206 62 kΩ ±1%	1			R15
NTC 13Ø 2 ΩSCK132	1			NTC
1206 MLCC X7R 102P 50 V ±10%	2			C9, C12
1206 MLCC X7R 102P 1 kV ±10%	1			C8
1206 MLCC X7R 103P 50 V ±10%	1			C13
1206 MLCC X7R 222P 50 V ±10%	1			C15
Electrolytic Capacitor 10 µF 50 V 105°C	1	LHK	JACKCON	C11
Electrolytic Capacitor 120 µF 420 V 105°C	1	LHK	PAG	C4
Electrolytic Capacitor 1000 µF 10 V 105°C	2	LHK	SAMXON	C6, C7
X2 Capacitor 0.47 µF 275 V ±20%	1			C1
Y1 Capacitor 222P 250 V ±20%	1			C14
Inductor 14 mH	1	TRN0183	SEN HUEI	L1
Inductor 2.5 µH	1	TRN0204	SEN HUEI	L2
Transformer EI-22 900 µH	1	TRN0317	SEN HUEI	TX1
Schottky Diode 5 A / 40 V	1	SB540	FAIRCHILD	D1
Fast Diode 1 A / 1000 V	1	1N4007	FAIRCHILD	D2
Fast Diode 1 A / 200 V	1	1N4935	FAIRCHILD	D3
SMD Fast Diode 1 A / 1000 V	2	S1M	FAIRCHILD	D6, D7
Bridge 2 A / 800 V	1	2KBP08M	FAIRCHILD	BD1
REGULATOR KA431L ±0.5%	1		FAIRCHILD	U3
IC FOD817A DIP	1		FAIRCHILD	U2
FUSE CERAMIC 250 V 1 A 3.6*10 mm	1	SLOW 37SG	SLEEK	F1
Varistor 7ψ470 V	1			MOV
TVS Breakdown Voltage 143 V–158 V	1	P6KE150A	FAIRCHILD	D8
Test Pin SG004-05	4			L N VO+ VO-
PCB PLM0152 REV0	1		FAIRCHILD	
FSB127HNY	1		FAIRCHILD	U1

7. Transformer

7.1. Transformer Specification

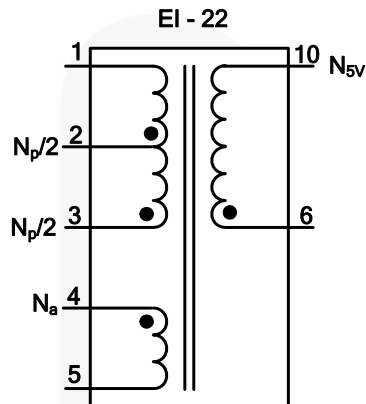

Core: EI-22 ($A_e=37.5 \text{ mm}^2$)
Bobbin: EI-22

Figure 21. Transformer Specification

Table 1. Winding Specifications

	Pins (S → F)	Wire	Turns	Winding Method
$N_p/2$	3 → 2	0.27 ϕ ×1	31	Solenoid Winding
Insulation: Polyester Tape t = 0.025 mm, 3 Layer				
N_{sv}	6 → 10	0.55 ϕ ×2	5	Solenoid Winding
Insulation: Polyester Tape t = 0.025 mm, 3 Layers				
$N_p/2$	2 → 1	0.27 ϕ ×1	31	Solenoid Winding
Insulation: Polyester Tape t = 0.025 mm, 6 Layers				
N_a	4 → 5	0.15 ϕ ×1	12	Solenoid Winding
Insulation: Polyester Tape t = 0.025 mm, 3 Layers				

Table 2. Specifications

	Pins	Specifications	Remark
Primary-Side Inductance	1 - 3	900 μ H \pm 10%	100 kHz, 1 V
Primary-Side Effective Leakage	1 - 3	< 30 Ω H Max.	Short All Other Pins

8. Revision History

Rev.	Date	Description
1.0.0	11/10/11	Initial release
1.0.1	02/04/13	Modify description of test condition

WARNING AND DISCLAIMER

Replace components on the Evaluation Board only with those parts shown on the parts list (or Bill of Materials) in the Users' Guide. Contact an authorized Fairchild representative with any questions.

This board is intended to be used by certified professionals, in a lab environment, following proper safety procedures. Use at your own risk. The Evaluation board (or kit) is for demonstration purposes only and neither the Board nor this User's Guide constitute a sales contract or create any kind of warranty, whether express or implied, as to the applications or products involved. Fairchild warrants that its products meet Fairchild's published specifications, but does not guarantee that its products work in any specific application. Fairchild reserves the right to make changes without notice to any products described herein to improve reliability, function, or design. Either the applicable sales contract signed by Fairchild and Buyer or, if no contract exists, Fairchild's standard Terms and Conditions on the back of Fairchild invoices, govern the terms of sale of the products described herein.

DISCLAIMER

FAIRCHILD SEMICONDUCTOR RESERVES THE RIGHT TO MAKE CHANGES WITHOUT FURTHER NOTICE TO ANY PRODUCTS HEREIN TO IMPROVE RELIABILITY, FUNCTION, OR DESIGN. FAIRCHILD DOES NOT ASSUME ANY LIABILITY ARISING OUT OF THE APPLICATION OR USE OF ANY PRODUCT OR CIRCUIT DESCRIBED HEREIN; NEITHER DOES IT CONVEY ANY LICENSE UNDER ITS PATENT RIGHTS, NOR THE RIGHTS OF OTHERS.

LIFE SUPPORT POLICY

FAIRCHILD'S PRODUCTS ARE NOT AUTHORIZED FOR USE AS CRITICAL COMPONENTS IN LIFE SUPPORT DEVICES OR SYSTEMS WITHOUT THE EXPRESS WRITTEN APPROVAL OF THE PRESIDENT OF FAIRCHILD SEMICONDUCTOR CORPORATION.

As used herein:

1. Life support devices or systems are devices or systems which, (a) are intended for surgical implant into the body, or (b) support or sustain life, or (c) whose failure to perform when properly used in accordance with instructions for use provided in the labeling, can be reasonably expected to result in significant injury to the user.
2. A critical component is any component of a life support device or system whose failure to perform can be reasonably expected to cause the failure of the life support device or system, or to affect its safety or effectiveness.

ANTI-COUNTERFEITING POLICY

Fairchild Semiconductor Corporation's Anti-Counterfeiting Policy. Fairchild's Anti-Counterfeiting Policy is also stated on our external website, www.fairchildsemi.com, under Sales Support.

Counterfeiting of semiconductor parts is a growing problem in the industry. All manufacturers of semiconductor products are experiencing counterfeiting of their parts. Customers who inadvertently purchase counterfeit parts experience many problems such as loss of brand reputation, substandard performance, failed applications, and increased cost of production and manufacturing delays. Fairchild is taking strong measures to protect ourselves and our customers from the proliferation of counterfeit parts. Fairchild strongly encourages customers to purchase Fairchild parts either directly from Fairchild or from Authorized Fairchild Distributors who are listed by country on our web page cited above. Products customers buy either from Fairchild directly or from Authorized Fairchild Distributors are genuine parts, have full traceability, meet Fairchild's quality standards for handling and storage and provide access to Fairchild's full range of up-to-date technical and product information. Fairchild and our Authorized Distributors will stand behind all warranties and will appropriately address any warranty issues that may arise. Fairchild will not provide any warranty coverage or other assistance for parts bought from Unauthorized Sources. Fairchild is committed to combat this global problem and encourage our customers to do their part in stopping this practice by buying direct or from authorized distributors.

EXPORT COMPLIANCE STATEMENT

These commodities, technology, or software were exported from the United States in accordance with the Export Administration Regulations for the ultimate destination listed on the commercial invoice. Diversion contrary to U.S. law is prohibited.

U.S. origin products and products made with U.S. origin technology are subject to U.S. Re-export laws. In the event of re-export, the user will be responsible to ensure the appropriate U.S. export regulations are followed.

ON Semiconductor and  are trademarks of Semiconductor Components Industries, LLC dba ON Semiconductor or its subsidiaries in the United States and/or other countries. ON Semiconductor owns the rights to a number of patents, trademarks, copyrights, trade secrets, and other intellectual property. A listing of ON Semiconductor's product/patent coverage may be accessed at www.onsemi.com/site/pdf/Patent-Marking.pdf. ON Semiconductor reserves the right to make changes without further notice to any products herein. ON Semiconductor makes no warranty, representation or guarantee regarding the suitability of its products for any particular purpose, nor does ON Semiconductor assume any liability arising out of the application or use of any product or circuit, and specifically disclaims any and all liability, including without limitation special, consequential or incidental damages. Buyer is responsible for its products and applications using ON Semiconductor products, including compliance with all laws, regulations and safety requirements or standards, regardless of any support or applications information provided by ON Semiconductor. "Typical" parameters which may be provided in ON Semiconductor data sheets and/or specifications can and do vary in different applications and actual performance may vary over time. All operating parameters, including "Typicals" must be validated for each customer application by customer's technical experts. ON Semiconductor does not convey any license under its patent rights nor the rights of others. ON Semiconductor products are not designed, intended, or authorized for use as a critical component in life support systems or any FDA Class 3 medical devices or medical devices with a same or similar classification in a foreign jurisdiction or any devices intended for implantation in the human body. Should Buyer purchase or use ON Semiconductor products for any such unintended or unauthorized application, Buyer shall indemnify and hold ON Semiconductor and its officers, employees, subsidiaries, affiliates, and distributors harmless against all claims, costs, damages, and expenses, and reasonable attorney fees arising out of, directly or indirectly, any claim of personal injury or death associated with such unintended or unauthorized use, even if such claim alleges that ON Semiconductor was negligent regarding the design or manufacture of the part. ON Semiconductor is an Equal Opportunity/Affirmative Action Employer. This literature is subject to all applicable copyright laws and is not for resale in any manner.

PUBLICATION ORDERING INFORMATION

LITERATURE FULFILLMENT:

Literature Distribution Center for ON Semiconductor
19521 E. 32nd Pkwy, Aurora, Colorado 80011 USA
Phone: 303-675-2175 or 800-344-3860 Toll Free USA/Canada
Fax: 303-675-2176 or 800-344-3867 Toll Free USA/Canada
Email: orderlit@onsemi.com

N. American Technical Support: 800-282-9855 Toll Free
USA/Canada
Europe, Middle East and Africa Technical Support:
Phone: 421 33 790 2910
Japan Customer Focus Center
Phone: 81-3-5817-1050

ON Semiconductor Website: www.onsemi.com
Order Literature: <http://www.onsemi.com/orderlit>
For additional information, please contact your local
Sales Representative