



Is Now Part of



**ON Semiconductor®**

To learn more about ON Semiconductor, please visit our website at  
[www.onsemi.com](http://www.onsemi.com)

ON Semiconductor and the ON Semiconductor logo are trademarks of Semiconductor Components Industries, LLC dba ON Semiconductor or its subsidiaries in the United States and/or other countries. ON Semiconductor owns the rights to a number of patents, trademarks, copyrights, trade secrets, and other intellectual property. A listing of ON Semiconductor's product/patent coverage may be accessed at [www.onsemi.com/site/pdf/Patent-Marking.pdf](http://www.onsemi.com/site/pdf/Patent-Marking.pdf). ON Semiconductor reserves the right to make changes without further notice to any products herein. ON Semiconductor makes no warranty, representation or guarantee regarding the suitability of its products for any particular purpose, nor does ON Semiconductor assume any liability arising out of the application or use of any product or circuit, and specifically disclaims any and all liability, including without limitation special, consequential or incidental damages. Buyer is responsible for its products and applications using ON Semiconductor products, including compliance with all laws, regulations and safety requirements or standards, regardless of any support or applications information provided by ON Semiconductor. "Typical" parameters which may be provided in ON Semiconductor data sheets and/or specifications can and do vary in different applications and actual performance may vary over time. All operating parameters, including "Typicals" must be validated for each customer application by customer's technical experts. ON Semiconductor does not convey any license under its patent rights nor the rights of others. ON Semiconductor products are not designed, intended, or authorized for use as a critical component in life support systems or any FDA Class 3 medical devices or medical devices with a same or similar classification in a foreign jurisdiction or any devices intended for implantation in the human body. Should Buyer purchase or use ON Semiconductor products for any such unintended or unauthorized application, Buyer shall indemnify and hold ON Semiconductor and its officers, employees, subsidiaries, affiliates, and distributors harmless against all claims, costs, damages, and expenses, and reasonable attorney fees arising out of, directly or indirectly, any claim of personal injury or death associated with such unintended or unauthorized use, even if such claim alleges that ON Semiconductor was negligent regarding the design or manufacture of the part. ON Semiconductor is an Equal Opportunity/Affirmative Action Employer. This literature is subject to all applicable copyright laws and is not for resale in any manner.



# AN-6039

## Board Layout Techniques for High-Performance Amplifiers

### General Layout Guidelines

General layout and supply bypassing play major roles in high-frequency performance. The most sensitive pins of a high-speed amplifier are the inverting input and output pins. For best performance, follow these general layout guidelines:

- Use a ground plane on the board to provide components with a low-inductive ground connection. However, remove the ground plane under and around the high-speed amplifier, especially near the input and output pins, to reduce stray capacitance.
- Use surface mount components whenever possible for the low lead inductances. If leaded components are used, minimize the lead lengths, especially  $R_f$  and  $R_g$ , to reduce series inductances at the inverting input of the amplifier.
- Utilize a compact layout and minimize all trace lengths, especially  $R_f$  and  $R_g$ , to reduce series inductances at the inverting input of the amplifier.
- Do not use sockets. Soldering a surface mount package directly to printed circuit board provides the best results. If necessary, use flush-mount socket pins rather than high-profile socket pins.

Figures 1 and 2 show the recommended layout for a high performance 4:1 multiplexer, such as FHP3194. Figure 3 shows a layout that includes the ground plane under the sensitive feedback and gain setting resistors of this current feedback amplifier.

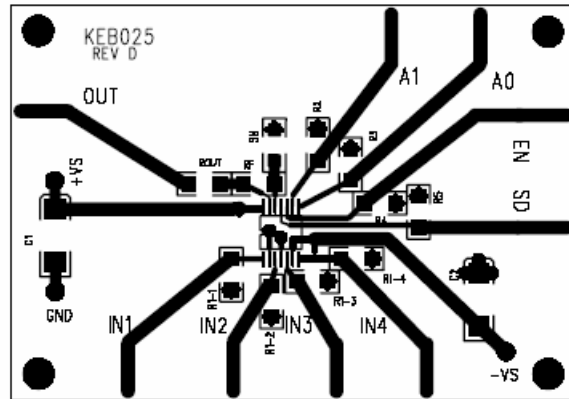

Figure 1. Recommended Layout for FHP3194 (Top View)

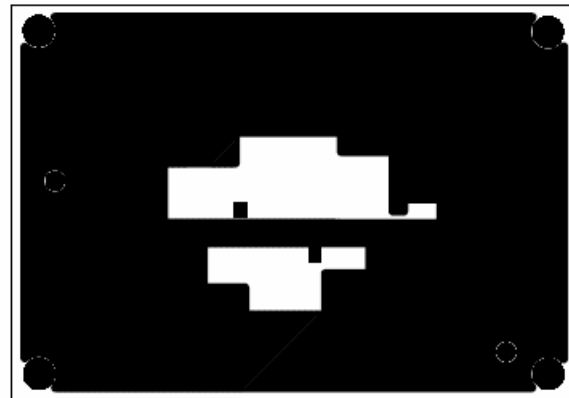

Figure 2. Recommended Layout for FHP3194 (Bottom View)



Figure 3. Ground Under  $R_f$  and  $R_g$  (Bottom View)

Figure 4 shows the frequency response of the FHP3194 in two conditions:

1. Using the recommended layout procedure; removing the ground plane under and around the part, especially near the input and output pins, and under  $R_f$  and  $R_g$  to reduce parasitic capacitance.
2. Using the recommended layout procedure without removing the ground plane under  $R_f$  and  $R_g$ .

The additional ground plane under  $R_f$  and  $R_g$  causes nearly 1dB of peaking on the signal response.

Removing the ground plane near the inputs of an amplifier can reduce stray board capacitance. Stray capacitance on the amplifier inputs can cause adverse effects to both the frequency and pulse response of a high-speed amplifier. Improper probing techniques can also cause stray input capacitance. Figure 5 shows the frequency and pulse responses of a high-speed amplifier, under normal conditions and with “induced” stray input capacitance. Stray input capacitance causes peaking in the frequency response, overshoot and undershoot in the pulse response, and overall issues with stability.

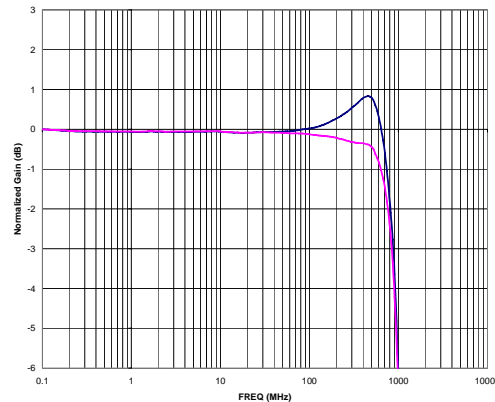

Figure 4. Frequency Response Illustrating Ground Plane Removal Under  $R_f$  &  $R_g$

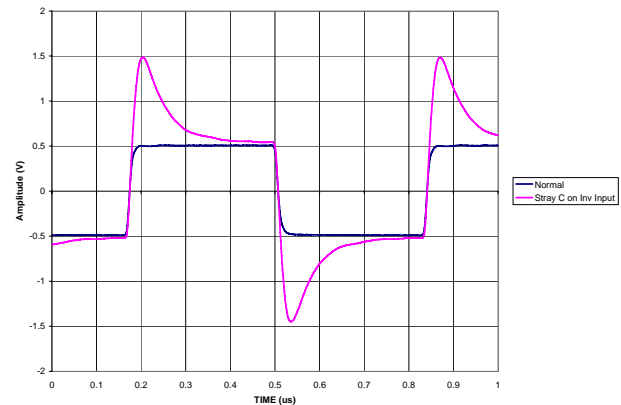
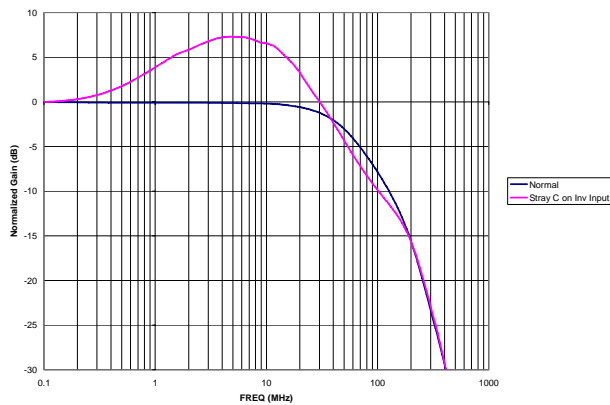

Figure 5. Pulse and Frequency Response Plots Illustrating the Effect of Stray Input Capacitance

## General Supply Bypassing Considerations

Use bypass capacitors on each supply. Bypass capacitors provide a low-impedance return current path at the power pins, improved power supply noise rejection, and high-frequency filtering on the power supply traces. Refer to the manufacturer's datasheet for recommended capacitor values. Most manufacturers recommend 6.8 $\mu$ F tantalum capacitors and 0.1 $\mu$ F ceramic capacitors. In some cases, several amplifiers can share the tantalum capacitor; but for optimum results, use a ceramic capacitor for every amplifier in the system.

To achieve optimum performance, place the capacitors as shown in Figure 6:

- Place the 6.8 $\mu$ F capacitor within 0.75 inches of the power pin.
- Place the 0.1 $\mu$ F capacitor within 0.1 inches of the power pin.

It is important to place the ceramic capacitors within 0.1 inches of the power pins. As the distance increases, the capacitor becomes less effective due to the added trace inductance. Figure 6 illustrates an example for a single-supply amplifier. If a dual-supply amplifier is used, include the same bypass capacitors for the other supply.

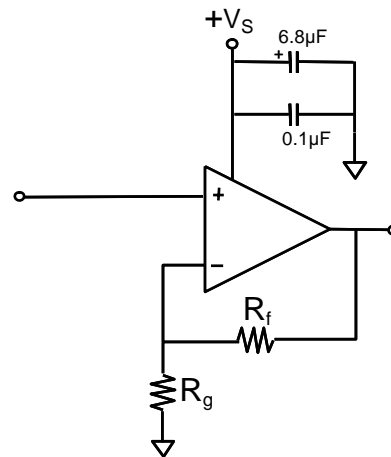

**Figure 6. Figure 5: Basic Amplifier Non-Inverting Gain Configuration for a Single-Supply Amplifier**

Figure 6 shows a typical frequency and pulse response plots for a high performance amplifier with > 500MHz of bandwidth. Both plots show the normal response, including both bypass capacitors as recommended, and without each bypass capacitor, and without both.

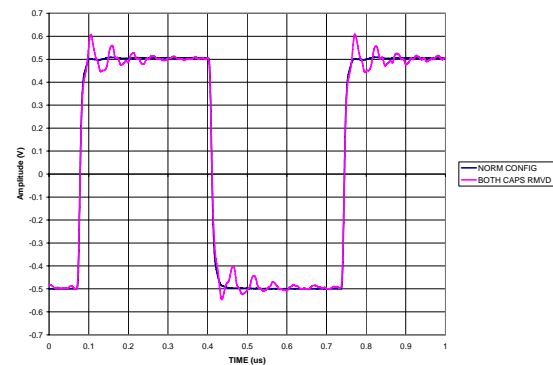
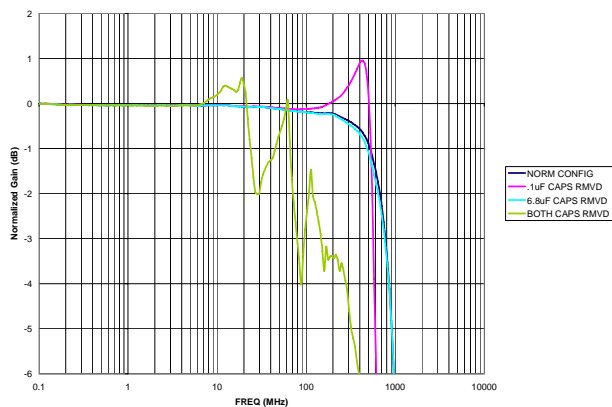

**Figure 7. Pulse and Frequency Response Plots Illustrating the Effect of Bypass Capacitors**

## Summary

When designing with a high-speed amplifier, follow these basic layout guidelines:

- Use a ground plane for board layout, but eliminate the ground plane near inputs/outputs
- Eliminate long lead lengths or use surface mount components
- Eliminate any parasitic capacitances or inductances near the I/O terminals
- Use supply bypass capacitors on each supply pin
- Place the bypass capacitors as close as possible to the amplifier's supply pins

## Related Products

FHP3130	Single, High Speed, 2.5V to 12V, Rail to Rail Amplifier
FHP3230	Dual, High Speed, 2.7V to 12V, Rail to Rail Amplifier
FHP3430	Quad, High Speed, 2.7V to 12V, Rail to Rail Amplifier
FHP3450	High Performance Amplifier
FHP3350	High Performance Amplifier
FHP3194	High Performance Multiplexer

---

### DISCLAIMER

FAIRCHILD SEMICONDUCTOR RESERVES THE RIGHT TO MAKE CHANGES WITHOUT FURTHER NOTICE TO ANY PRODUCTS HEREIN TO IMPROVE RELIABILITY, FUNCTION, OR DESIGN. FAIRCHILD DOES NOT ASSUME ANY LIABILITY ARISING OUT OF THE APPLICATION OR USE OF ANY PRODUCT OR CIRCUIT DESCRIBED HEREIN; NEITHER DOES IT CONVEY ANY LICENSE UNDER ITS PATENT RIGHTS, NOR THE RIGHTS OF OTHERS.

### LIFE SUPPORT POLICY

FAIRCHILD'S PRODUCTS ARE NOT AUTHORIZED FOR USE AS CRITICAL COMPONENTS IN LIFE SUPPORT DEVICES OR SYSTEMS WITHOUT THE EXPRESS WRITTEN APPROVAL OF THE PRESIDENT OF FAIRCHILD SEMICONDUCTOR CORPORATION.

As used herein:

1. Life support devices or systems are devices or systems which, (a) are intended for surgical implant into the body, or (b) support or sustain life, or (c) whose failure to perform when properly used in accordance with instructions for use provided in the labeling, can be reasonably expected to result in significant injury to the user.
2. A critical component is any component of a life support device or system whose failure to perform can be reasonably expected to cause the failure of the life support device or system, or to affect its safety or effectiveness.

ON Semiconductor and  are trademarks of Semiconductor Components Industries, LLC dba ON Semiconductor or its subsidiaries in the United States and/or other countries. ON Semiconductor owns the rights to a number of patents, trademarks, copyrights, trade secrets, and other intellectual property. A listing of ON Semiconductor's product/patent coverage may be accessed at [www.onsemi.com/site/pdf/Patent-Marking.pdf](http://www.onsemi.com/site/pdf/Patent-Marking.pdf). ON Semiconductor reserves the right to make changes without further notice to any products herein. ON Semiconductor makes no warranty, representation or guarantee regarding the suitability of its products for any particular purpose, nor does ON Semiconductor assume any liability arising out of the application or use of any product or circuit, and specifically disclaims any and all liability, including without limitation special, consequential or incidental damages. Buyer is responsible for its products and applications using ON Semiconductor products, including compliance with all laws, regulations and safety requirements or standards, regardless of any support or applications information provided by ON Semiconductor. "Typical" parameters which may be provided in ON Semiconductor data sheets and/or specifications can and do vary in different applications and actual performance may vary over time. All operating parameters, including "Typicals" must be validated for each customer application by customer's technical experts. ON Semiconductor does not convey any license under its patent rights nor the rights of others. ON Semiconductor products are not designed, intended, or authorized for use as a critical component in life support systems or any FDA Class 3 medical devices or medical devices with a same or similar classification in a foreign jurisdiction or any devices intended for implantation in the human body. Should Buyer purchase or use ON Semiconductor products for any such unintended or unauthorized application, Buyer shall indemnify and hold ON Semiconductor and its officers, employees, subsidiaries, affiliates, and distributors harmless against all claims, costs, damages, and expenses, and reasonable attorney fees arising out of, directly or indirectly, any claim of personal injury or death associated with such unintended or unauthorized use, even if such claim alleges that ON Semiconductor was negligent regarding the design or manufacture of the part. ON Semiconductor is an Equal Opportunity/Affirmative Action Employer. This literature is subject to all applicable copyright laws and is not for resale in any manner.

## PUBLICATION ORDERING INFORMATION

### LITERATURE FULFILLMENT:

Literature Distribution Center for ON Semiconductor  
19521 E. 32nd Pkwy, Aurora, Colorado 80011 USA  
**Phone:** 303-675-2175 or 800-344-3860 Toll Free USA/Canada  
**Fax:** 303-675-2176 or 800-344-3867 Toll Free USA/Canada  
**Email:** [orderlit@onsemi.com](mailto:orderlit@onsemi.com)

**N. American Technical Support:** 800-282-9855 Toll Free  
USA/Canada  
**Europe, Middle East and Africa Technical Support:**  
Phone: 421 33 790 2910  
**Japan Customer Focus Center**  
Phone: 81-3-5817-1050

**ON Semiconductor Website:** [www.onsemi.com](http://www.onsemi.com)  
**Order Literature:** <http://www.onsemi.com/orderlit>  
For additional information, please contact your local  
Sales Representative