

AFGB40T65SQDN

IGBT for Automotive Applications, 650 V, 40 A, D²PAK

Features

- Maximum Junction Temperature: $T_J = 175^\circ\text{C}$
- High Speed Switching Series
- $V_{CE(sat)} = 1.6\text{ V (Typ.) @ } I_C = 40\text{ A}$
- 100% of the Part are Dynamically Tested (Note 1)
- AEC-Q101 Qualified
- These Devices are Pb-Free and are RoHS Compliant

Typical Applications

- Automotive On Board Charger
- Automotive DC/DC Converter for HEV

ABSOLUTE MAXIMUM RATINGS

($T_J = 25^\circ\text{C}$ unless otherwise stated)

Parameter	Symbol	Value	Unit
Collector to Emitter Voltage	V_{CES}	650	V
Gate-to-Emitter Voltage	V_{GES}	± 20	V
Transient Gate-to-Emitter Voltage	V_{GES}	± 30	V
Collector Current – $T_C = 25^\circ\text{C}$	I_C	80	A
Collector Current – $T_C = 100^\circ\text{C}$		40	A
Pulsed Collector Current (Note 2)	I_{CM}	160	A
Diode Forward Current – $T_C = 25^\circ\text{C}$	I_F	40	A
Diode Forward Current – $T_C = 100^\circ\text{C}$		20	A
Pulsed Diode Maximum Forward Current (Note 2)	I_{FM}	160	A
Maximum Power Dissipation – $T_C = 25^\circ\text{C}$	P_D	238	W
Maximum Power Dissipation – $T_C = 100^\circ\text{C}$		119	W
Operating Junction and Storage Temperature	T_J, T_{stg}	-55 to 175	$^\circ\text{C}$

Stresses exceeding those listed in the Maximum Ratings table may damage the device. If any of these limits are exceeded, device functionality should not be assumed, damage may occur and reliability may be affected.

1. $V_{CC} = 400\text{ V}$, $V_{GE} = 15\text{ V}$, $I_C = 120\text{ A}$, $R_G = 100\ \Omega$, Inductive Load.
2. Repetitive rating: pulse width limited by max. Junction temperature.
3. Surface-mounted on FR4 board using 1 in² pad size, 1 oz Cu pad.
4. The entire application environment impacts the thermal resistance values shown, they are not constants and are only valid for the particular conditions noted.



ON Semiconductor®

www.onsemi.com

BV_{CES}	$V_{CE(sat)}$ TYP	I_C MAX
650 V	1.6 V	160 A

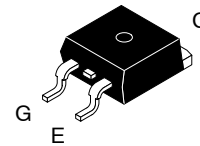
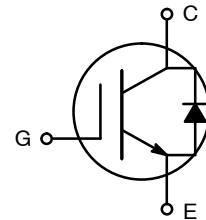

D²PAK-3
CASE 418AJ

MARKING DIAGRAM

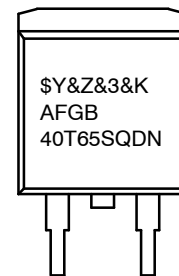

$\$Y$ = ON Semiconductor Logo
 $\&Z$ = Assembly Plant Code
 $\&3$ = 3-Digit Data Code
 $\&K$ = 2-Digit Lot Traceability Code
 AFGB40T65SQDN = Specific Device Code

ORDERING INFORMATION

Device	Package	Shipping†
AFGB40T65SQDN	D ² PAK	800 Units / Tape & Reel

†For information on tape and reel specifications, including part orientation and tape sizes, please refer to our Tape and Reel Packaging Specification Brochure, BRD8011/D.

AFGB40T65SQDN

THERMAL CHARACTERISTICS

Parameter	Symbol	Max	Unit
Thermal Resistance Junction-to-Case, for IGBT	$R_{\theta JC}$	0.63	°C/W
Thermal Resistance Junction-to-Case, for Diode	$R_{\theta JC}$	1.55	
Thermal Resistance Junction-to-Ambient	$R_{\theta JA}$	40	

ELECTRICAL CHARACTERISTICS ($T_C = 25^\circ\text{C}$ unless otherwise stated)

Parameter	Symbol	Test Condition	Min	Typ	Max	Unit
-----------	--------	----------------	-----	-----	-----	------

OFF CHARACTERISTICS

Collector to Emitter Breakdown Voltage	BV_{CES}	$V_{GE} = 0\text{ V}, I_C = 1\text{ mA}$	650	-	-	V
Temperature Coefficient of Breakdown Voltage	$\Delta V_{CES}/\Delta T_J$	$I_C = 1\text{ mA}$, Reference to 25°C	-	0.6	-	V/°C
Collector Cut-Off Current	I_{CES}	$V_{CE} = V_{CES}, V_{GE} = 0\text{ V}$	-	-	250	μA
G-E Leakage Current	I_{GES}	$V_{GE} = V_{GES}, V_{CE} = 0\text{ V}$	-	-	± 400	nA

ON CHARACTERISTICS

Gate Threshold Voltage	$V_{GE(th)}$	$V_{GE} = V_{CE}, I_C = 40\text{ mA}$	2.6	4.5	6.4	V
Collector to Emitter Saturation Voltage	$V_{CE(sat)}$	$I_C = 40\text{ A}, V_{GE} = 15\text{ V}, T_C = 25^\circ\text{C}$	-	1.6	2.1	V
		$I_C = 40\text{ A}, V_{GE} = 15\text{ V}, T_C = 175^\circ\text{C}$	-	1.92	-	V

DYNAMIC CHARACTERISTIC

Input Capacitance	C_{ies}	$V_{CE} = 30\text{ V}, V_{GE} = 0\text{ V}, f = 1\text{ MHz}$	-	2495	-	pF
Output Capacitance	C_{oes}		-	50	-	
Reverse Transfer Capacitance	C_{res}		-	9	-	

SWITCHING CHARACTERISTIC

Turn-On Delay Time	$t_{d(on)}$	$V_{CC} = 400\text{ V}, I_C = 40\text{ A}, R_G = 6\ \Omega,$ $V_{GE} = 15\text{ V}$, Inductive Load, $T_C = 25^\circ\text{C}$	-	17.6	-	ns
Rise Time	t_r		-	19.2	-	ns
Turn-Off Delay Time	$t_{d(off)}$		-	75.2	-	ns
Fall Time	t_f		-	9.6	-	ns
Turn-On Switching Loss	E_{on}		-	0.858	-	mJ
Turn-Off Switching Loss	E_{off}		-	0.229	-	mJ
Total Switching Loss	E_{ts}		-	1.087	-	mJ
Turn-On Delay Time	$t_{d(on)}$	$V_{CC} = 400\text{ V}, I_C = 40\text{ A}, R_G = 6\ \Omega,$ $V_{GE} = 15\text{ V}$, Inductive Load, $T_C = 175^\circ\text{C}$	-	16	-	ns
Rise Time	t_r		-	22.4	-	ns
Turn-Off Delay Time	$t_{d(off)}$		-	81.6	-	ns
Fall Time	t_f		-	20.8	-	ns
Turn-On Switching Loss	E_{on}		-	1.14	-	mJ
Turn-Off Switching Loss	E_{off}		-	0.484	-	mJ
Total Switching Loss	E_{ts}		-	1.624	-	mJ
Total Gate Charge	Q_g	$V_{CE} = 400\text{ V}, I_C = 40\text{ A}, V_{GE} = 15\text{ V}$	-	76	-	nC
Gate to Emitter Charge	Q_{ge}		-	14	-	nC
Gate to Collector Charge	Q_{gc}		-	17	-	nC

AFGB40T65SQDN

ELECTRICAL CHARACTERISTICS ($T_C = 25^\circ\text{C}$ unless otherwise stated) (continued)

Parameter	Symbol	Test Condition	Min	Typ	Max	Unit
-----------	--------	----------------	-----	-----	-----	------

ELECTRICAL CHARACTERISTIC OF THE DIODE ($T_J = 25^\circ\text{C}$ unless otherwise stated)

Diode Forward Voltage	V _{FM}	$I_F = 20\text{ A}$	-	1.5	2.1	V
Reverse Recovery Energy	E_{rec}	$I_F = 20\text{ A}$ $dI_F/dt = 200\text{ A}/\mu\text{s}$, $T_C = 25^\circ\text{C}$	-	22.3	-	μJ
Diode Reverse Recovery Time	t_{rr}		-	131	-	ns
Diode Reverse Recovery Charge	Q_{rr}		-	348	-	nC
Reverse Recovery Energy	E_{rec}	$I_F = 20\text{ A}$ $dI_F/dt = 200\text{ A}/\mu\text{s}$, $T_C = 175^\circ\text{C}$	-	100	-	μJ
Diode Reverse Recovery Time	t_{rr}		-	245	-	ns
Diode Reverse Recovery Charge	Q_{rr}		-	961	-	nC

Product parametric performance is indicated in the Electrical Characteristics for the listed test conditions, unless otherwise noted. Product performance may not be indicated by the Electrical Characteristics if operated under different conditions.

AFGB40T65SQDN

TYPICAL CHARACTERISTICS

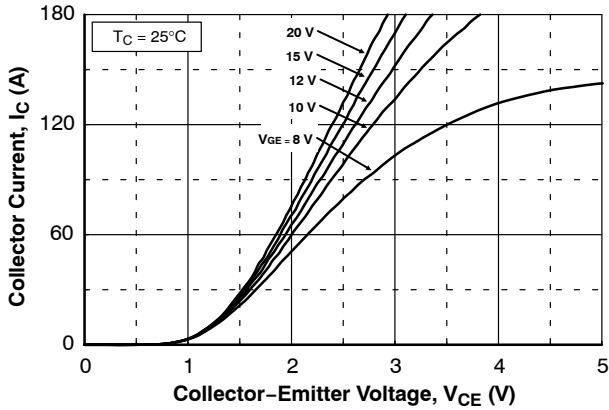

Figure 1. Typical Output Characteristics (25°C)

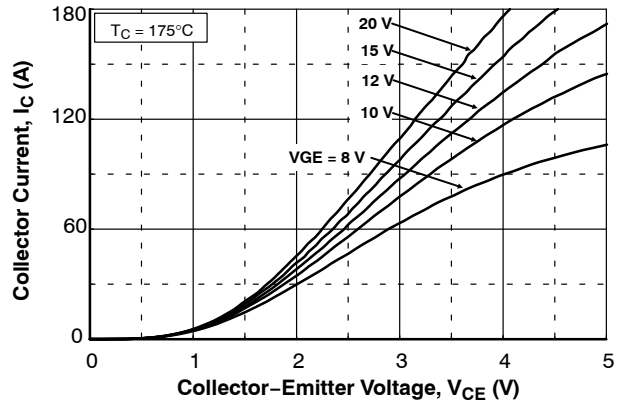

Figure 2. Typical Output Characteristics (175°C)

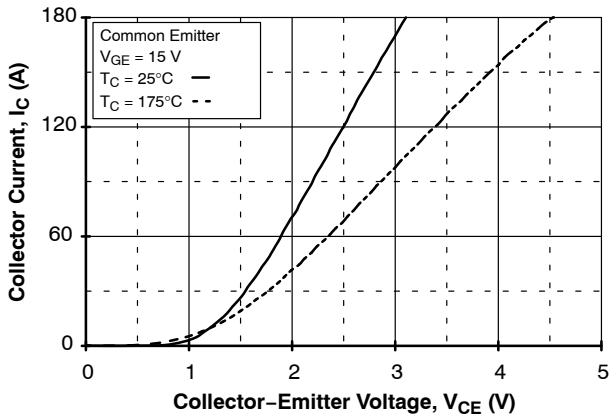

Figure 3. Typical Saturation Voltage Characteristics

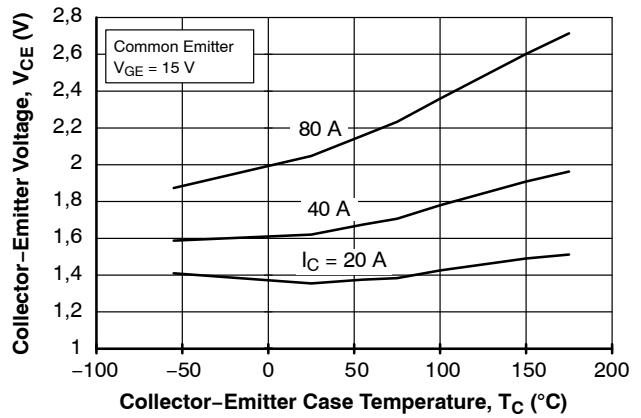

Figure 4. Saturation Voltage vs Case Temperature at Variant Current Level

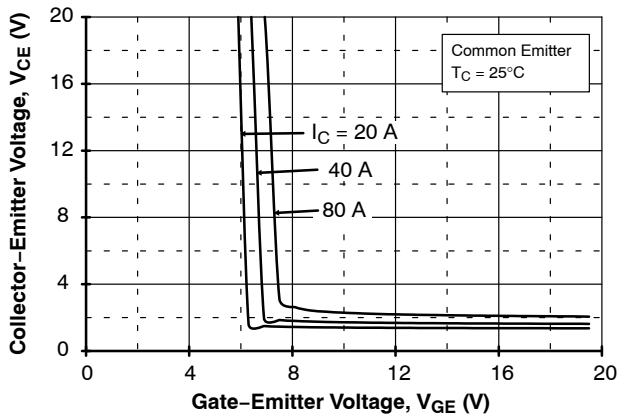

Figure 5. Saturation Voltage vs V_{GE} (25°C)

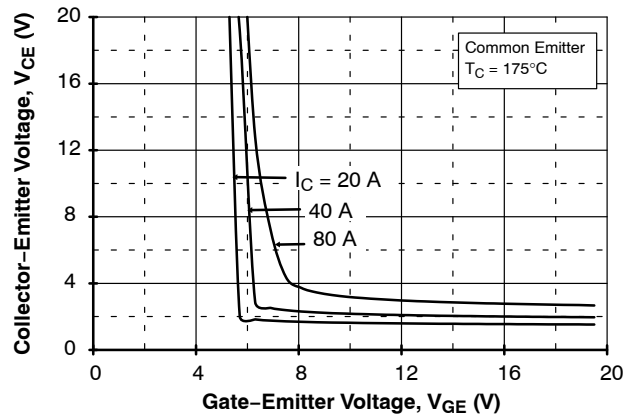

Figure 6. Saturation Voltage vs V_{GE} (175°C)

AFGB40T65SQDN

TYPICAL CHARACTERISTICS

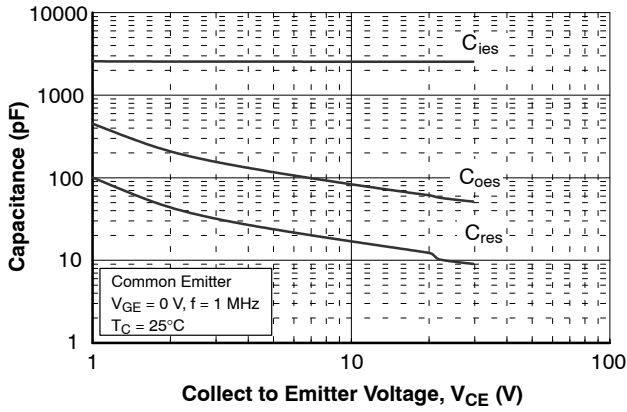

Figure 7. Capacitance Characteristics

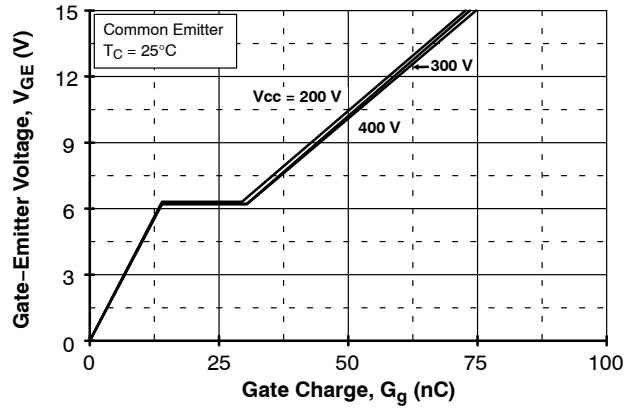

Figure 8. Gate Charge Characteristics

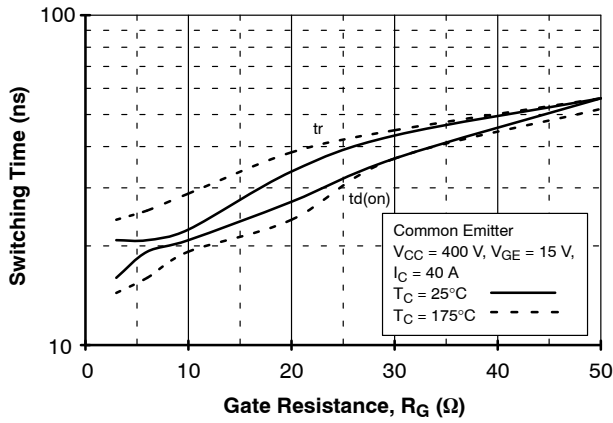

Figure 9. Turn-On Characteristics vs Gate Resistance

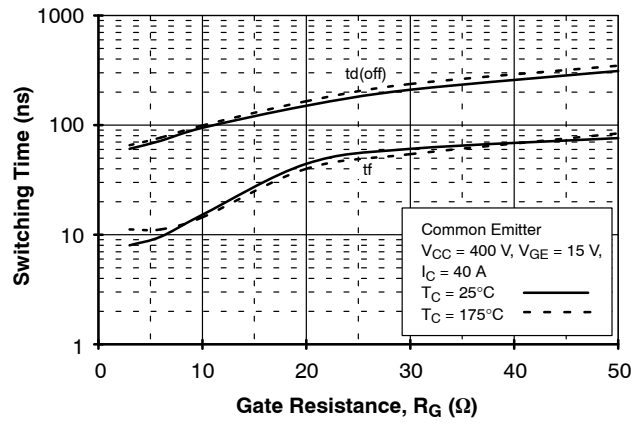

Figure 10. Turn-Off Characteristics vs Gate Resistance

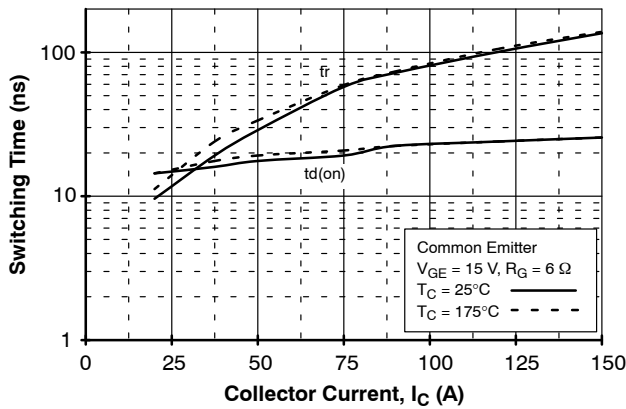

Figure 11. Turn-On Characteristics vs Collector Current

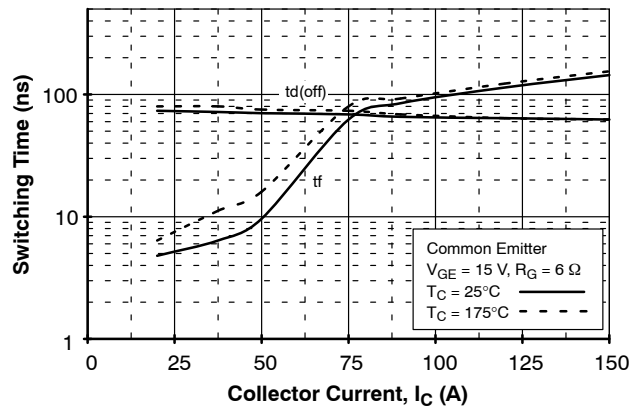

Figure 12. Turn-Off Characteristics vs Collector Current

AFGB40T65SQDN

TYPICAL CHARACTERISTICS

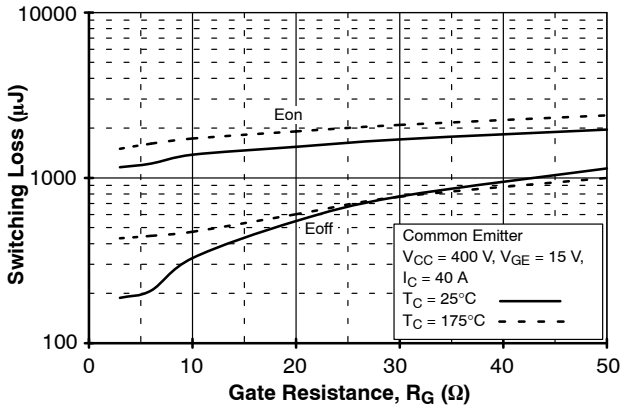

Figure 13. Switching Loss vs Gate Resistance

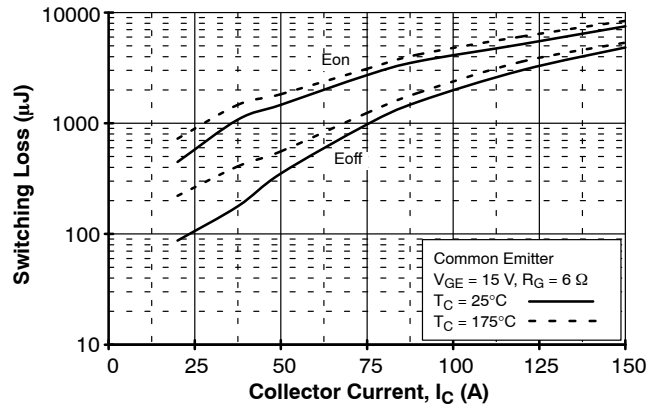

Figure 14. Switching Loss vs Collector Current

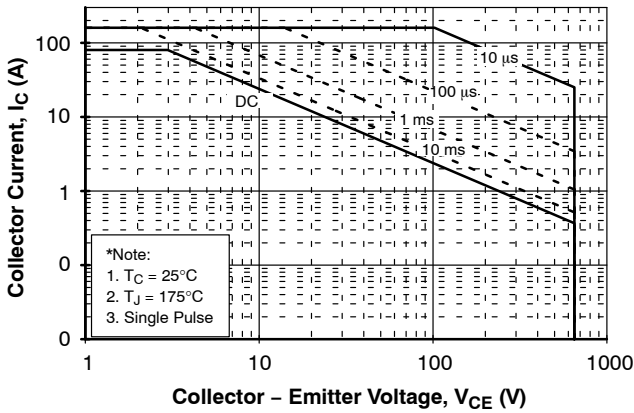

Figure 15. SOA Characteristics

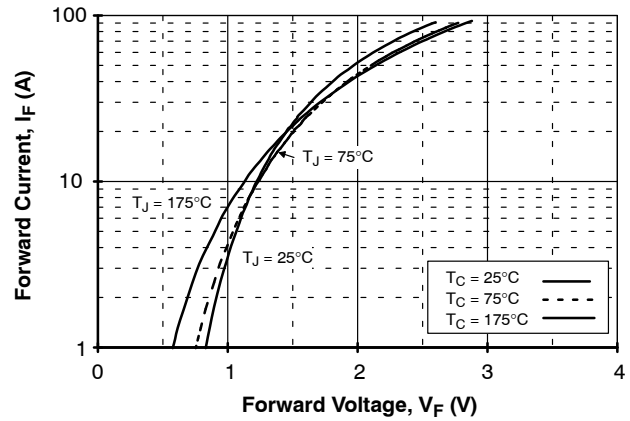

Figure 16. Forward Characteristics

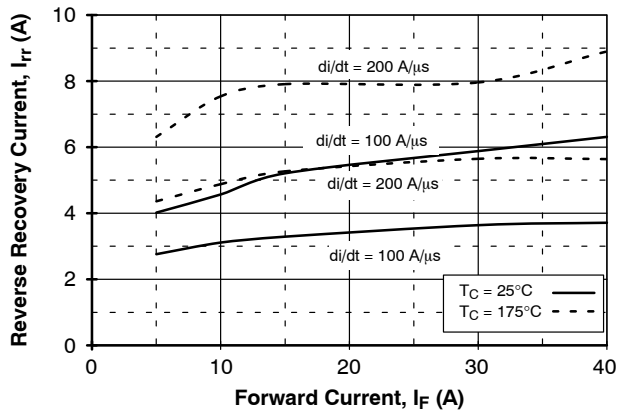

Figure 17. Reverse Recovery Current

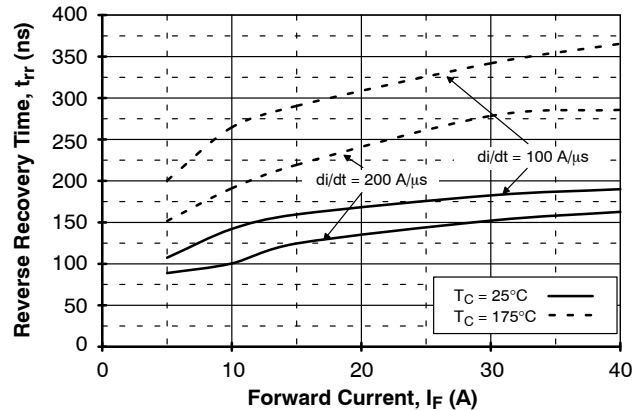

Figure 18. Reverse Recovery Time

AFGB40T65SQDN

TYPICAL CHARACTERISTICS

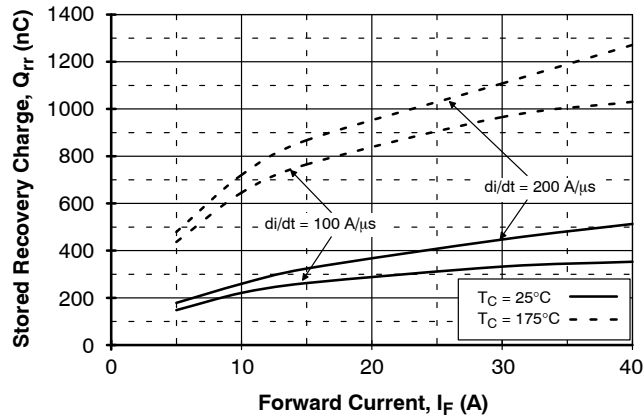

Figure 19. Stored Charge

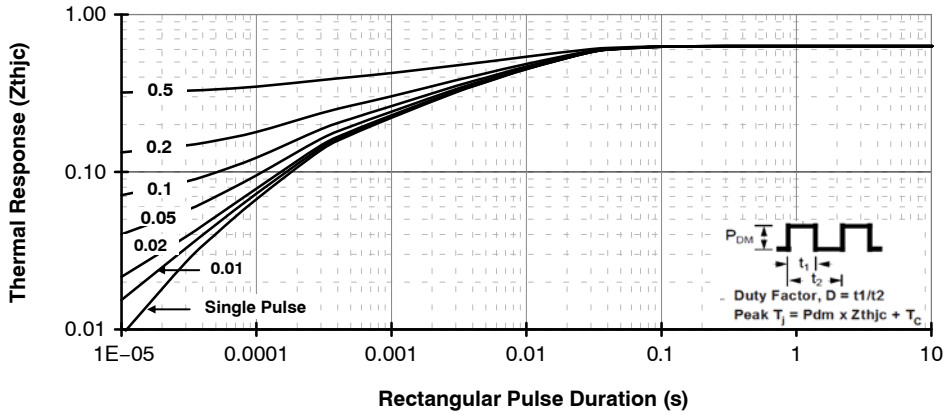

Figure 20. Transient Thermal Impedance of IGBT

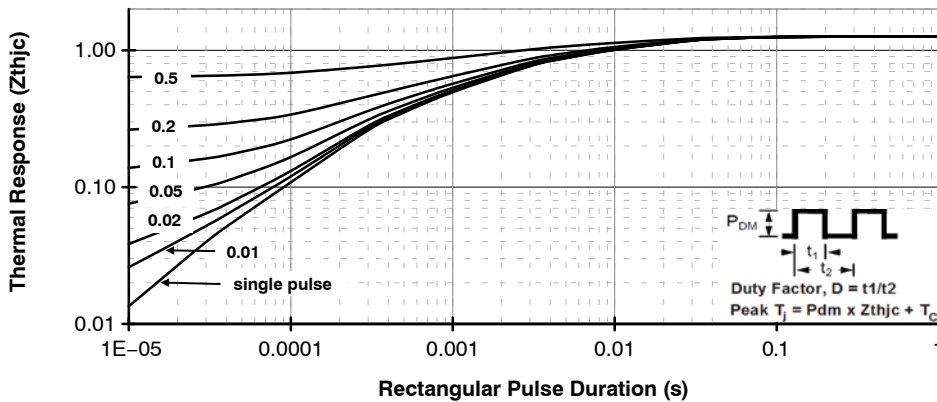

Figure 21. Transient Thermal Impedance of Diode

MECHANICAL CASE OUTLINE

PACKAGE DIMENSIONS

ON Semiconductor®



D²PAK-3 (TO-263, 3-LEAD)

CASE 418AJ

ISSUE C

DATE 03 OCT 2018

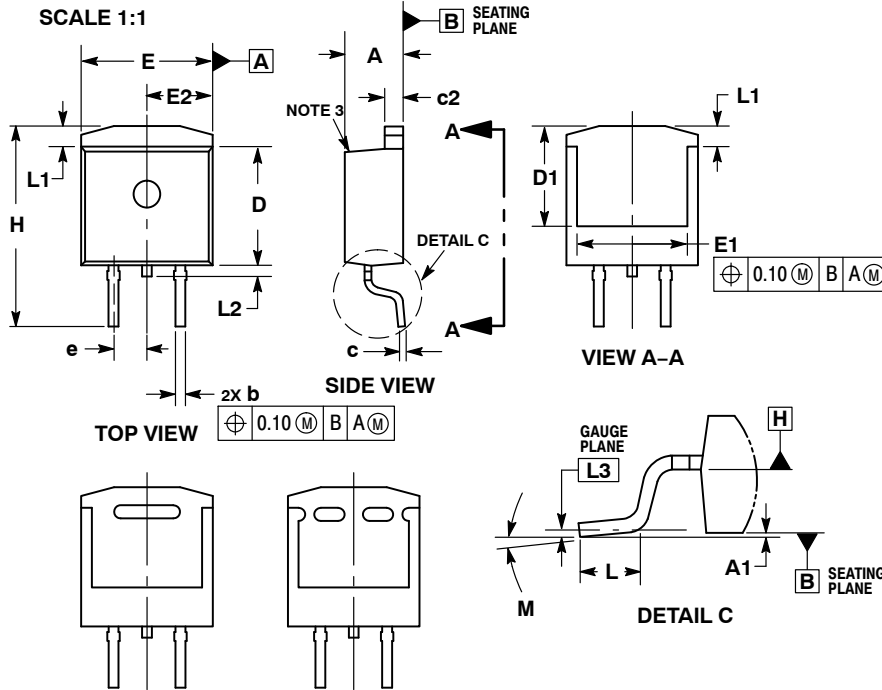
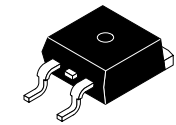

NOTES:

1. DIMENSIONING AND TOLERANCING PER ASME Y14.5M, 1994.
2. CONTROLLING DIMENSION: INCHES.
3. CHAMFER OPTIONAL
4. DIMENSIONS D AND E DO NOT INCLUDE MOLD FLASH. MOLD FLASH SHALL NOT EXCEED 0.005 PER SIDE. THESE DIMENSIONS ARE MEASURED AT THE OUTERMOST EXTREMES OF THE PLASTIC BODY AT DATUM H.
5. THERMAL PAD CONTOUR IS OPTIONAL WITHIN DIMENSIONS E, L1, D1 AND E1.

DIM	INCHES		MILLIMETERS	
	MIN	MAX	MIN	MAX
A	0.160	0.190	4.06	4.83
A1	0.000	0.010	0.00	0.25
b	0.020	0.039	0.51	0.99
c	0.012	0.029	0.30	0.74
c2	0.045	0.065	1.14	1.65
D	0.330	0.380	8.38	9.65
D1	0.260	---	6.60	---
E	0.380	0.420	9.65	10.67
E1	0.245	---	6.22	---
e	0.100 BSC		2.54 BSC	
H	0.575	0.625	14.60	15.88
L	0.070	0.110	1.78	2.79
L1	---	0.066	---	1.68
L2	---	0.070	---	1.78
L3	0.010 BSC		0.25 BSC	
M	-8°	8°	-8°	8°

VIEW A-A
OPTIONAL CONSTRUCTIONS

RECOMMENDED SOLDERING FOOTPRINT*

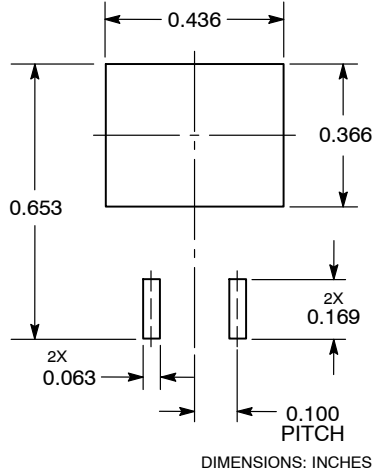

GENERIC MARKING DIAGRAMS*

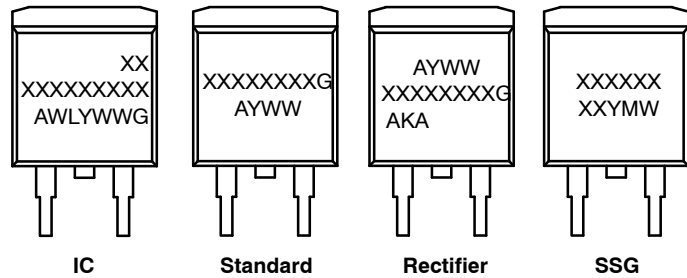

- XXXXXX = Specific Device Code
- A = Assembly Location
- WL = Wafer Lot
- Y = Year
- WW = Work Week
- W = Week Code (SSG)
- M = Month Code (SSG)
- G = Pb-Free Package
- AKA = Polarity Indicator

*For additional information on our Pb-Free strategy and soldering details, please download the ON Semiconductor Soldering and Mounting Techniques Reference Manual, SOLDERRM/D.

*This information is generic. Please refer to device data sheet for actual part marking. Pb-Free indicator, "G" or microdot "•", may or may not be present. Some products may not follow the Generic Marking.

DOCUMENT NUMBER:	98AON56370E	Electronic versions are uncontrolled except when accessed directly from the Document Repository. Printed versions are uncontrolled except when stamped "CONTROLLED COPY" in red.
DESCRIPTION:	D ² PAK-3 (TO-263, 3-LEAD)	PAGE 1 OF 1

ON Semiconductor and are trademarks of Semiconductor Components Industries, LLC dba ON Semiconductor or its subsidiaries in the United States and/or other countries. ON Semiconductor reserves the right to make changes without further notice to any products herein. ON Semiconductor makes no warranty, representation or guarantee regarding the suitability of its products for any particular purpose, nor does ON Semiconductor assume any liability arising out of the application or use of any product or circuit, and specifically disclaims any and all liability, including without limitation special, consequential or incidental damages. ON Semiconductor does not convey any license under its patent rights nor the rights of others.

ON Semiconductor and  are trademarks of Semiconductor Components Industries, LLC dba ON Semiconductor or its subsidiaries in the United States and/or other countries. ON Semiconductor owns the rights to a number of patents, trademarks, copyrights, trade secrets, and other intellectual property. A listing of ON Semiconductor's product/patent coverage may be accessed at www.onsemi.com/site/pdf/Patent-Marking.pdf. ON Semiconductor reserves the right to make changes without further notice to any products herein. ON Semiconductor makes no warranty, representation or guarantee regarding the suitability of its products for any particular purpose, nor does ON Semiconductor assume any liability arising out of the application or use of any product or circuit, and specifically disclaims any and all liability, including without limitation special, consequential or incidental damages. Buyer is responsible for its products and applications using ON Semiconductor products, including compliance with all laws, regulations and safety requirements or standards, regardless of any support or applications information provided by ON Semiconductor. "Typical" parameters which may be provided in ON Semiconductor data sheets and/or specifications can and do vary in different applications and actual performance may vary over time. All operating parameters, including "Typicals" must be validated for each customer application by customer's technical experts. ON Semiconductor does not convey any license under its patent rights nor the rights of others. ON Semiconductor products are not designed, intended, or authorized for use as a critical component in life support systems or any FDA Class 3 medical devices or medical devices with a same or similar classification in a foreign jurisdiction or any devices intended for implantation in the human body. Should Buyer purchase or use ON Semiconductor products for any such unintended or unauthorized application, Buyer shall indemnify and hold ON Semiconductor and its officers, employees, subsidiaries, affiliates, and distributors harmless against all claims, costs, damages, and expenses, and reasonable attorney fees arising out of, directly or indirectly, any claim of personal injury or death associated with such unintended or unauthorized use, even if such claim alleges that ON Semiconductor was negligent regarding the design or manufacture of the part. ON Semiconductor is an Equal Opportunity/Affirmative Action Employer. This literature is subject to all applicable copyright laws and is not for resale in any manner.

PUBLICATION ORDERING INFORMATION

LITERATURE FULFILLMENT:

Literature Distribution Center for ON Semiconductor
19521 E. 32nd Pkwy, Aurora, Colorado 80011 USA
Phone: 303-675-2175 or 800-344-3860 Toll Free USA/Canada
Fax: 303-675-2176 or 800-344-3867 Toll Free USA/Canada
Email: orderlit@onsemi.com

N. American Technical Support: 800-282-9855 Toll Free
USA/Canada
Europe, Middle East and Africa Technical Support:
Phone: 421 33 790 2910

ON Semiconductor Website: www.onsemi.com

Order Literature: <http://www.onsemi.com/orderlit>

For additional information, please contact your local
Sales Representative