

Product Overview

AR0237: CMOS Image Sensor, 2.1 MP, 1/2.7"

For complete documentation, see the data sheet.

The AR0237 is a 1/2.7-inch CMOS digital image sensor with an active-pixel array of 1928 (H) x 1088 (V). It captures images in either linear or high dynamic range modes with a rolling-shutter readout, and includes sophisticated camera functions such as in-pixel binning, windowing and both video and single frame modes. It is designed for both low light and high dynamic range scene performance, and is programmable through a simple two-wire serial interface. The AR0237 produces extraordinarily clear, sharp digital pictures, and its ability to capture both continuous video and single frames makes it the perfect choice for a wide range of applications, including surveillance and HD video.

Features

- Superior low-light performance
- DR-PIX (TM) technology with Dual Conversion Gain
- Full HD support at up to 1080p 60 fps for superior video performance
- Linear or high dynamic range capture
- On-chip phase-locked loop (PLL) oscillator
- Supports line interleaved T1/T2 readout to enable HDR processing in ISP chip
- Support for external mechanical shutter
- Integrated position-based color and lens shading correction
- Slave mode for precise frame-rate control
- Stereo/3D camera support

For more features, see the data sheet

Applications

- Video surveillance
- 1080p60 (Surveillance) video applications
- High dynamic range imaging

End Products

- Surveillance camera

Part Electrical Specifications

Product	Pricing (\$/Unit)	Compliance	Status	Type	Megapixels	Frame Rate (fps)	Optical Format	Shutter Type	Pixel Size (µm)	Output Interface	Color	Package Type
AR0237C5SC00SHRA0-DR		Pb-free Halide free non AEC-Q and PPAP	Active	CMOS	2.1	60	1/2.7 inch	Electronic Rolling and Global Reset Release	3.0 x 3.0	HiSPi™	Bayer Color	PLCC-48
AR0237C5SC00SPRA0-DR		Pb-free Halide free non AEC-Q and PPAP	Active	CMOS	2.1	60	1/2.7 inch	Electronic Rolling and Global Reset Release	3.0 x 3.0	Parallel	Bayer Color	PLCC-48
AR0237C5SC12SPRA0-DR		Pb-free Halide free non AEC-Q and PPAP	Active	CMOS	2.1	60	1/2.7 inch	Electronic Rolling and Global Reset Release	3.0 x 3.0	Parallel	Bayer Color	PLCC-48

Application Diagram

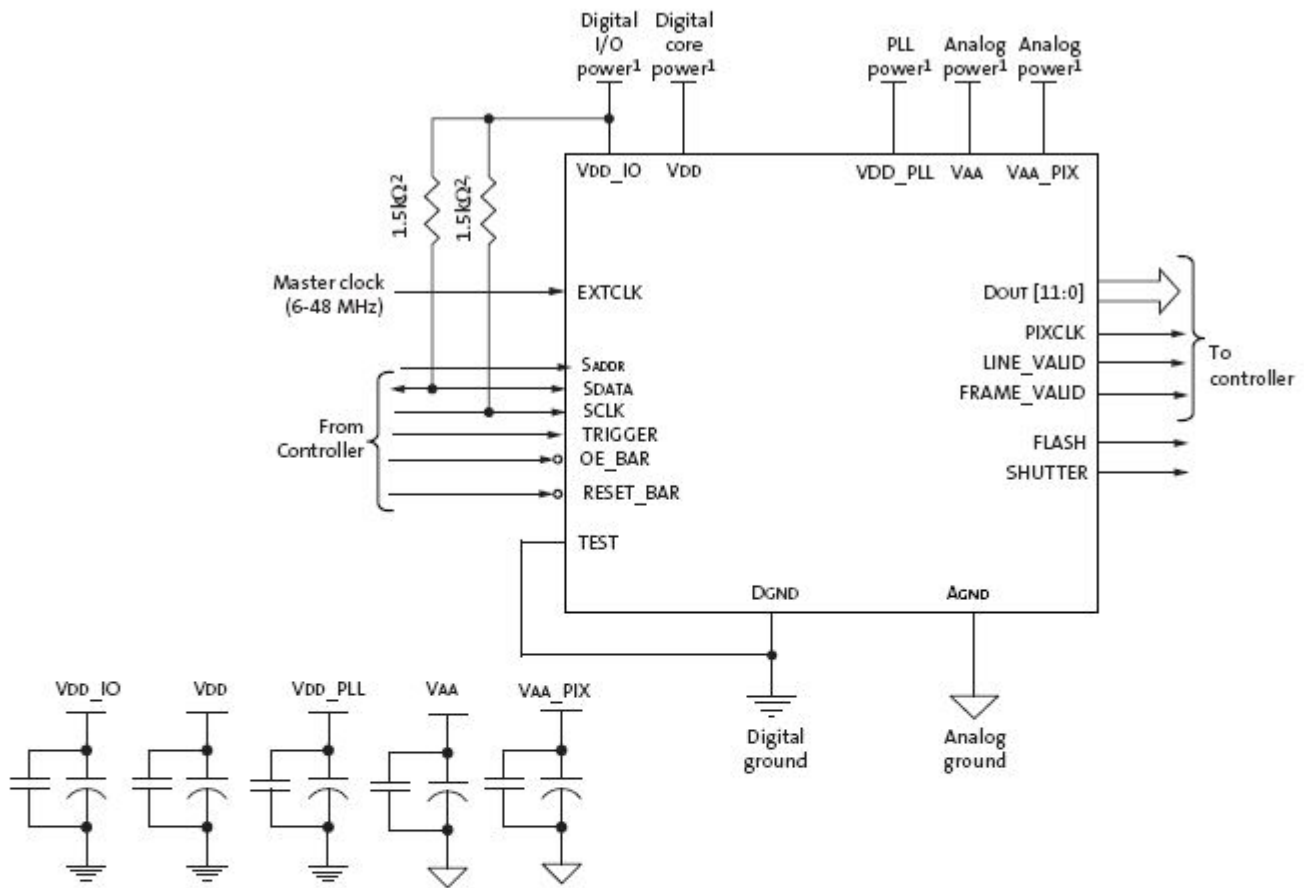

- Notes:
1. All power supplies must be adequately decoupled.
 2. ON Semiconductor recommends a resistor value of 1.5kΩ, but a greater value may be used for slower two-wire speed.
 3. The serial interface output pads and VDDSLVS can be left unconnected if the parallel output interface is used.
 4. ON Semiconductor recommends that 0.1μF and 10μF decoupling capacitors for each power supply are mounted as close as possible to the pad. Actual values and results may vary depending on layout and design considerations. Refer to the AR0237 demo headboard schematics for circuit recommendations.
 5. ON Semiconductor recommends that analog power planes are placed in a manner such that coupling with the digital power planes is minimized.
 6. I/O signals voltage must be configured to match VDD_IO voltage to minimize any leakage currents.
 7. The EXTCLK input is limited to 6-48 MHz.

For more information please contact your local sales support at www.onsemi.com.

Created on: 10/23/2021