

ULN2003A, ULQ2003A

High Voltage, High Current Darlington Transistor Arrays

The seven NPN Darlington connected transistors in these arrays are well suited for driving lamps, relays, or printer hammers in a variety of industrial and consumer applications. Their high breakdown voltage and internal suppression diodes insure freedom from problems associated with inductive loads. Peak inrush currents to 500 mA permit them to drive incandescent lamps.

The ULx2003A with a 2.7 kΩ series input resistor is well suited for systems utilizing a 5.0 V TTL or CMOS Logic.

Features

- These are Pb-Free Devices



Figure 1. Representative Schematic Diagram

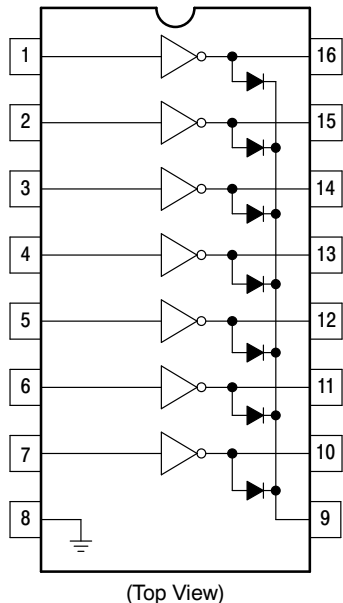

Figure 2. Pin Connections



ON Semiconductor®

<http://onsemi.com>



MARKING DIAGRAMS

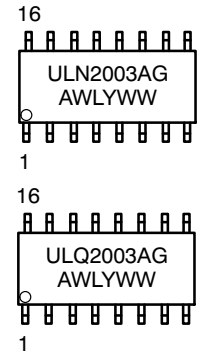

A = Assembly Location
WL = Wafer Lot
Y = Year
WW = Work Week
G = Pb-Free Package

ORDERING INFORMATION

Device	Package	Shipping†
ULN2003ADR2G	SOIC-16 (Pb-Free)	2500 Tape & Reel
ULQ2003ADR2G	SOIC-16 (Pb-Free)	2500 Tape & Reel

†For information on tape and reel specifications, including part orientation and tape sizes, please refer to our Tape and Reel Packaging Specifications Brochure, BRD8011/D.

ULN2003A, ULQ2003A

MAXIMUM RATINGS ($T_A = 25^\circ\text{C}$, and rating apply to any one device in the package, unless otherwise noted.)

Rating	Symbol	Value	Unit
Output Voltage	V_O	50	V
Input Voltage	V_I	30	V
Collector Current - Continuous	I_C	500	mA
Base Current - Continuous	I_B	25	mA
Operating Ambient Temperature Range ULN2003A ULQ2003A	T_A	-20 to +85 -40 to +85	$^\circ\text{C}$
Storage Temperature Range	T_{stg}	-55 to +150	$^\circ\text{C}$
Junction Temperature	T_J	150	$^\circ\text{C}$
Thermal Resistance, Junction-to-Ambient Case 751B, D Suffix	$R_{\theta JA}$	100	$^\circ\text{C}/\text{W}$
Thermal Resistance, Junction-to-Case Case 751B, D Suffix	$R_{\theta JC}$	20	$^\circ\text{C}/\text{W}$
Electrostatic Discharge Sensitivity (ESD) Human Body Model (HBM) Machine Model (MM) Charged Device Model (CDM)	ESD	2000 400 1500	V

Stresses exceeding Maximum Ratings may damage the device. Maximum Ratings are stress ratings only. Functional operation above the Recommended Operating Conditions is not implied. Extended exposure to stresses above the Recommended Operating Conditions may affect device reliability.

ULN2003A, ULQ2003A

ELECTRICAL CHARACTERISTICS ($T_A = 25^\circ\text{C}$, unless otherwise noted)

Characteristic	Symbol	Min	Typ	Max	Unit
Output Leakage Current ($V_O = 50\text{ V}$, $T_A = +85^\circ\text{C}$) ($V_O = 50\text{ V}$, $T_A = +25^\circ\text{C}$)	I_{CEX}	- -	- -	100 50	μA
Collector-Emitter Saturation Voltage ($I_C = 350\text{ mA}$, $I_B = 500\text{ }\mu\text{A}$) ($I_C = 200\text{ mA}$, $I_B = 350\text{ }\mu\text{A}$) ($I_C = 100\text{ mA}$, $I_B = 250\text{ }\mu\text{A}$)	$V_{CE(sat)}$	- - -	1.1 0.95 0.85	1.6 1.3 1.1	V
Input Current - On Condition ($V_I = 3.85\text{ V}$)	$I_{I(on)}$	-	0.93	1.35	mA
Input Voltage - On Condition ($V_{CE} = 2.0\text{ V}$, $I_C = 200\text{ mA}$) ($V_{CE} = 2.0\text{ V}$, $I_C = 250\text{ mA}$) ($V_{CE} = 2.0\text{ V}$, $I_C = 300\text{ mA}$)	$V_{I(on)}$	- - -	- - -	2.4 2.7 3.0	V
Input Current - Off Condition ($I_C = 500\text{ }\mu\text{A}$, $T_A = 85^\circ\text{C}$)	$I_{I(off)}$	50	100	-	μA
DC Current Gain ($V_{CE} = 2.0\text{ V}$, $I_C = 350\text{ mA}$)	h_{FE}	1000	-	-	-
Input Capacitance	C_I	-	15	30	pF
Turn-On Delay Time (50% E_I to 50% E_O)	t_{on}	-	0.25	1.0	μs
Turn-Off Delay Time (50% E_I to 50% E_O)	t_{off}	-	0.25	1.0	μs
Clamp Diode Leakage Current ($V_R = 50\text{ V}$)	I_R	- -	- -	50 100	μA
Clamp Diode Forward Voltage ($I_F = 350\text{ mA}$)	V_F	-	1.5	2.0	V

ULN2003A, ULQ2003A

TYPICAL PERFORMANCE CURVES - $T_A = 25^\circ\text{C}$



Figure 3. Output Current versus Input Voltage

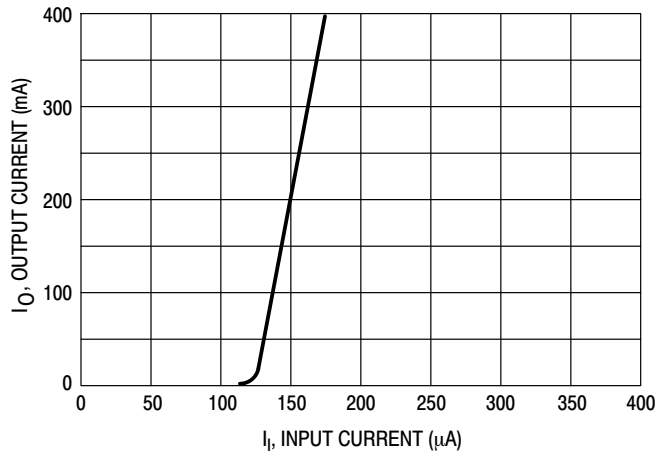

Figure 4. Output Current versus Input Current

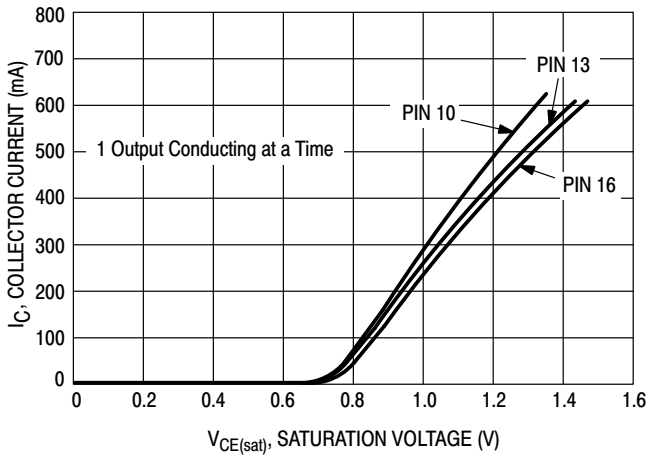

Figure 5. Typical Output Characteristics

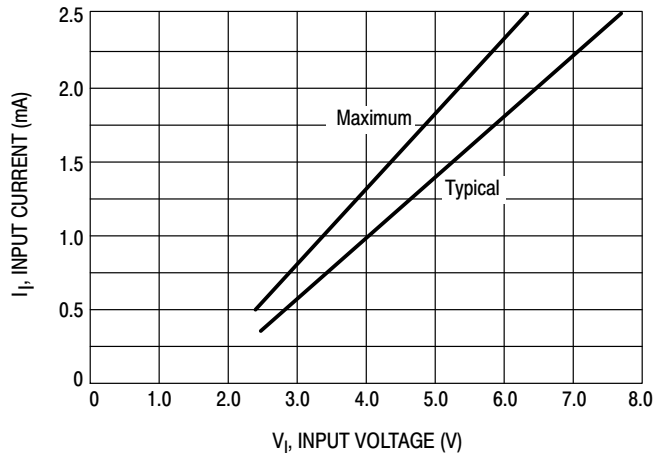

Figure 6. Input Characteristics



Figure 7. Maximum Collector Current versus Duty Cycle (and Number of Drivers in Use)



SOIC-16 9.90x3.90x1.37 1.27P
CASE 751B
ISSUE M

DATE 18 OCT 2024

NOTES:

1. DIMENSIONING AND TOLERANCING PER ASME Y14.5M, 2018.
2. DIMENSION IN MILLIMETERS. ANGLE IN DEGREES.
3. DIMENSIONS D AND E1 DO NOT INCLUDE MOLD PROTRUSION.
4. MAXIMUM MOLD PROTRUSION 0.15mm PER SIDE.
5. DIMENSION b DOES NOT INCLUDE DAMBAR PROTRUSION. ALLOWABLE DAMBAR PROTRUSION SHALL BE 0.127mm TOTAL IN EXCESS OF THE b DIMENSION AT MAXIMUM MATERIAL CONDITION.

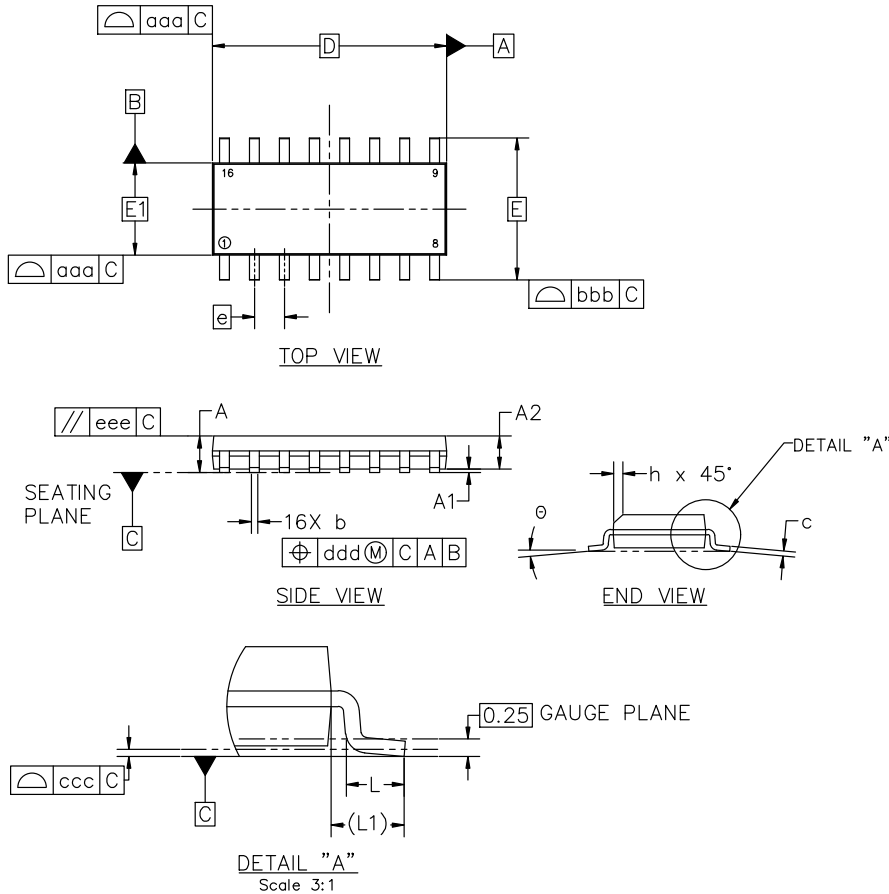

MILLIMETERS			
DIM	MIN	NOM	MAX
A	1.35	1.55	1.75
A1	0.10	0.18	0.25
A2	1.25	1.37	1.50
b	0.35	0.42	0.49
c	0.19	0.22	0.25
D	9.90 BSC		
E	6.00 BSC		
E1	3.90 BSC		
e	1.27 BSC		
h	0.25	---	0.50
L	0.40	0.83	1.25
L1	1.05 REF		
θ	0°	---	7°
TOLERANCE OF FORM AND POSITION			
aaa	0.10		
bbb	0.20		
ccc	0.10		
ddd	0.25		
eee	0.10		

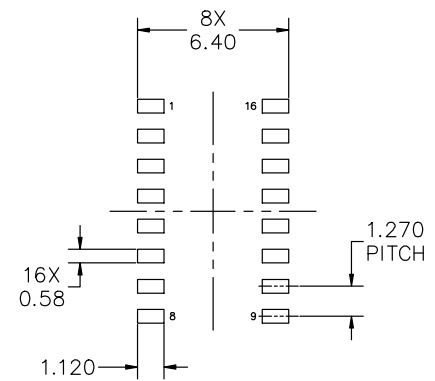

RECOMMENDED MOUNTING FOOTPRINT

*FOR ADDITIONAL INFORMATION ON OUR PB-FREE STRATEGY AND SOLDERING DETAILS, PLEASE DOWNLOAD THE onsemi SOLDERING AND MOUNTING TECHNIQUES REFERENCE MANUAL, SOLDERM/D

DOCUMENT NUMBER:	98ASB42566B	Electronic versions are uncontrolled except when accessed directly from the Document Repository. Printed versions are uncontrolled except when stamped "CONTROLLED COPY" in red.
DESCRIPTION:	SOIC-16 9.90X3.90X1.37 1.27P	PAGE 1 OF 2

onsemi and onSEMI are trademarks of Semiconductor Components Industries, LLC dba onsemi or its subsidiaries in the United States and/or other countries. onsemi reserves the right to make changes without further notice to any products herein. onsemi makes no warranty, representation or guarantee regarding the suitability of its products for any particular purpose, nor does onsemi assume any liability arising out of the application or use of any product or circuit, and specifically disclaims any and all liability, including without limitation special, consequential or incidental damages. onsemi does not convey any license under its patent rights nor the rights of others.

SOIC-16 9.90x3.90x1.37 1.27P
CASE 751B
ISSUE M

DATE 18 OCT 2024

**GENERIC
MARKING DIAGRAM***

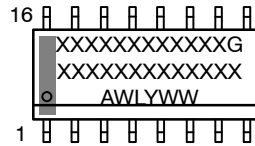

XXXXX = Specific Device Code
A = Assembly Location
WL = Wafer Lot
Y = Year
WW = Work Week
G = Pb-Free Package

*This information is generic. Please refer to device data sheet for actual part marking. Pb-Free indicator, "G" or microdot "▪", may or may not be present. Some products may not follow the Generic Marking.

<p>STYLE 1: PIN 1. COLLECTOR 2. BASE 3. EMITTER 4. NO CONNECTION 5. EMITTER 6. BASE 7. COLLECTOR 8. COLLECTOR 9. BASE 10. EMITTER 11. NO CONNECTION 12. EMITTER 13. BASE 14. COLLECTOR 15. EMITTER 16. COLLECTOR</p>	<p>STYLE 2: PIN 1. CATHODE 2. ANODE 3. NO CONNECTION 4. CATHODE 5. CATHODE 6. NO CONNECTION 7. ANODE 8. CATHODE 9. CATHODE 10. ANODE 11. NO CONNECTION 12. CATHODE 13. CATHODE 14. NO CONNECTION 15. ANODE 16. CATHODE</p>	<p>STYLE 3: PIN 1. COLLECTOR, DYE #1 2. BASE, #1 3. EMITTER, #1 4. COLLECTOR, #1 5. COLLECTOR, #2 6. BASE, #2 7. EMITTER, #2 8. COLLECTOR, #2 9. COLLECTOR, #3 10. BASE, #3 11. EMITTER, #3 12. COLLECTOR, #3 13. COLLECTOR, #4 14. BASE, #4 15. EMITTER, #4 16. COLLECTOR, #4</p>	<p>STYLE 4: PIN 1. COLLECTOR, DYE #1 2. COLLECTOR, #1 3. COLLECTOR, #2 4. COLLECTOR, #2 5. COLLECTOR, #3 6. COLLECTOR, #3 7. COLLECTOR, #4 8. COLLECTOR, #4 9. BASE, #4 10. EMITTER, #4 11. BASE, #3 12. EMITTER, #3 13. BASE, #2 14. EMITTER, #2 15. BASE, #1 16. EMITTER, #1</p>
<p>STYLE 5: PIN 1. DRAIN, DYE #1 2. DRAIN, #1 3. DRAIN, #2 4. DRAIN, #2 5. DRAIN, #3 6. DRAIN, #3 7. DRAIN, #4 8. DRAIN, #4 9. GATE, #4 10. SOURCE, #4 11. GATE, #3 12. SOURCE, #3 13. GATE, #2 14. SOURCE, #2 15. GATE, #1 16. SOURCE, #1</p>	<p>STYLE 6: PIN 1. CATHODE 2. CATHODE 3. CATHODE 4. CATHODE 5. CATHODE 6. CATHODE 7. CATHODE 8. CATHODE 9. ANODE 10. ANODE 11. ANODE 12. ANODE 13. ANODE 14. ANODE 15. ANODE 16. ANODE</p>	<p>STYLE 7: PIN 1. SOURCE N-CH 2. COMMON DRAIN (OUTPUT) 3. COMMON DRAIN (OUTPUT) 4. GATE P-CH 5. COMMON DRAIN (OUTPUT) 6. COMMON DRAIN (OUTPUT) 7. COMMON DRAIN (OUTPUT) 8. SOURCE P-CH 9. SOURCE P-CH 10. COMMON DRAIN (OUTPUT) 11. COMMON DRAIN (OUTPUT) 12. COMMON DRAIN (OUTPUT) 13. GATE N-CH 14. COMMON DRAIN (OUTPUT) 15. COMMON DRAIN (OUTPUT) 16. SOURCE N-CH</p>	

DOCUMENT NUMBER:	98ASB42566B	Electronic versions are uncontrolled except when accessed directly from the Document Repository. Printed versions are uncontrolled except when stamped "CONTROLLED COPY" in red.
DESCRIPTION:	SOIC-16 9.90X3.90X1.37 1.27P	PAGE 2 OF 2

onsemi and **ONSEMI** are trademarks of Semiconductor Components Industries, LLC dba **onsemi** or its subsidiaries in the United States and/or other countries. **onsemi** reserves the right to make changes without further notice to any products herein. **onsemi** makes no warranty, representation or guarantee regarding the suitability of its products for any particular purpose, nor does **onsemi** assume any liability arising out of the application or use of any product or circuit, and specifically disclaims any and all liability, including without limitation special, consequential or incidental damages. **onsemi** does not convey any license under its patent rights nor the rights of others.

onsemi, **Onsemi**, and other names, marks, and brands are registered and/or common law trademarks of Semiconductor Components Industries, LLC dba "**onsemi**" or its affiliates and/or subsidiaries in the United States and/or other countries. **onsemi** owns the rights to a number of patents, trademarks, copyrights, trade secrets, and other intellectual property. A listing of **onsemi**'s product/patent coverage may be accessed at www.onsemi.com/site/pdf/Patent-Marking.pdf. **onsemi** reserves the right to make changes at any time to any products or information herein, without notice. The information herein is provided "as-is" and **onsemi** makes no warranty, representation or guarantee regarding the accuracy of the information, product features, availability, functionality, or suitability of its products for any particular purpose, nor does **onsemi** assume any liability arising out of the application or use of any product or circuit, and specifically disclaims any and all liability, including without limitation special, consequential or incidental damages. Buyer is responsible for its products and applications using **onsemi** products, including compliance with all laws, regulations and safety requirements or standards, regardless of any support or applications information provided by **onsemi**. "Typical" parameters which may be provided in **onsemi** data sheets and/or specifications can and do vary in different applications and actual performance may vary over time. All operating parameters, including "Typicals" must be validated for each customer application by customer's technical experts. **onsemi** does not convey any license under any of its intellectual property rights nor the rights of others. **onsemi** products are not designed, intended, or authorized for use as a critical component in life support systems or any FDA Class 3 medical devices or medical devices with a same or similar classification in a foreign jurisdiction or any devices intended for implantation in the human body. Should Buyer purchase or use **onsemi** products for any such unintended or unauthorized application, Buyer shall indemnify and hold **onsemi** and its officers, employees, subsidiaries, affiliates, and distributors harmless against all claims, costs, damages, and expenses, and reasonable attorney fees arising out of, directly or indirectly, any claim of personal injury or death associated with such unintended or unauthorized use, even if such claim alleges that **onsemi** was negligent regarding the design or manufacture of the part. **onsemi** is an Equal Opportunity/Affirmative Action Employer. This literature is subject to all applicable copyright laws and is not for resale in any manner.

ADDITIONAL INFORMATION

TECHNICAL PUBLICATIONS:

Technical Library: www.onsemi.com/design/resources/technical-documentation
onsemi Website: www.onsemi.com

ONLINE SUPPORT: www.onsemi.com/support

For additional information, please contact your local Sales Representative at www.onsemi.com/support/sales