

Silicon Carbide (SiC) Cascode JFET – EliteSiC, Power N-Channel, TO-263-7, 750 V, 18 mohm

SiC JFET w/ Si MOSFET

UJ4SC075018B7S

Description

The UJ4SC075018B7S is a 750 V, 18 mΩ G4 SiC FET. It is based on a unique ‘cascode’ circuit configuration, in which a normally-on SiC JFET is co-packaged with a Si MOSFET to produce a normally-off SiC FET device. The device’s standard gate-drive characteristics allows for a true “drop-in replacement” to Si IGBTs, Si FETs, SiC MOSFETs or Si superjunction devices. Available in the TO-263-7 package, this device exhibits ultra-low gate charge and exceptional reverse recovery characteristics, making it ideal for switching inductive loads and any application requiring standard gate drive.

Features

- On-Resistance $R_{DS(on)}$: 18 mΩ (typ)
- Operating Temperature: 175 °C (Max)
- Excellent Reverse Recovery: Q_{rr} = 125 nC
- Low Body Diode V_{FSD} : 1.14 V
- Low Gate Charge : Q_G = 37.8 nC
- Threshold Voltage $V_{G(th)}$: 4.8 V (typ) Allowing 0 to 15 V Drive
- Low Intrinsic Capacitance
- ESD Protected: HBM Class 2
- TO-263-7 Package for Faster Switching, Clean Gate Waveforms
- This Device is Pb-Free, Halogen Free and is RoHS Compliant

Typical Applications

- EV Charging
- PV Inverters
- Switch Mode Power Supplies
- Power Factor Correction Modules
- Motor Drives
- Induction Heating

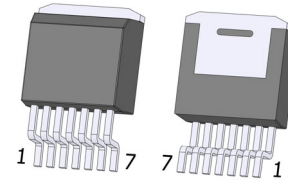

TO-263-7
 CASE 418BA

MARKING DIAGRAM

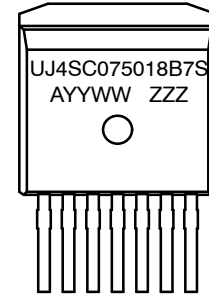

UJ4SC075018B7S = Specific Device Number
 A = Assembly Location
 YY = Year
 WW = Work Week
 ZZZ = Lot ID

PIN CONNECTIONS

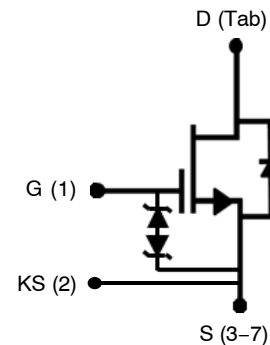

ORDERING INFORMATION

See detailed ordering and shipping information on page 9 of this data sheet.

UJ4SC075018B7S

MAXIMUM RATINGS

Symbol	Parameter	Test Conditions	Value	Unit
V _{DS}	Drain-Source Voltage		750	V
V _{GS}	Gate-Source Voltage	DC	-20 to +20	V
		AC (f > 1 Hz)	-25 to +25	V
I _D	Continuous Drain Current (Note 1)	T _C = 25 °C	72	A
		T _C = 100 °C	52	A
I _{DM}	Pulsed Drain Current (Note 2)	T _C = 25 °C	208	A
E _{AS}	Single Pulsed Avalanche Energy (Note 3)	L = 15 mH, I _{AS} = 3.6 A	97.2	mJ
dv/dt	SiC FET dv/dt Ruggedness	V _{DS} ≤ 500 V	200	V/ns
P _{tot}	Power Dissipation	T _C = 25 °C	259	W
T _{J,max}	Maximum Junction Temperature		175	°C
T _J , T _{STG}	Operating and Storage Temperature		-55 to 175	°C
T _{SOLDER}	Reflow Soldering Temperature	Reflow MSL 1	245	°C

Stresses exceeding those listed in the Maximum Ratings table may damage the device. If any of these limits are exceeded, device functionality should not be assumed, damage may occur and reliability may be affected.

1. Limited by T_{J,max}
2. Pulse width t_p limited by T_{J,max}
3. Starting T_J = 25 °C

THERMAL CHARACTERISTICS

Symbol	Parameter	Test Conditions	Min	Typ	Max	Unit
R _{θJC}	Thermal Resistance, Junction-to-Case		-	0.45	0.58	°C/W

UJ4SC075018B7S

ELECTRICAL CHARACTERISTICS (T_J = +25 °C unless otherwise specified)

Symbol	Parameter	Test Conditions	Min	Typ	Max	Unit	
TYPICAL PERFORMANCE – STATIC							
B _{VDS}	Drain-Source Breakdown Voltage	V _{GS} = 0 V, I _D = 1 mA	750	–	–	V	
I _{DSS}	Total Drain Leakage Current	V _{DS} = 750 V, V _{GS} = 0 V, T _J = 25 °C	–	1.3	45	μA	
		V _{DS} = 750 V, V _{GS} = 0 V, T _J = 175 °C	–	20	–		
I _{GSS}	Total Gate Leakage Current	V _{DS} = 0 V, T _J = 25 °C V _{GS} = –20 V / + 20 V	–	4.7	±20	μA	
R _{DS(on)}	Drain-Source On-resistance	V _{GS} = 12 V, I _D = 50 A	T _J = 25 °C	–	18	23	mΩ
			T _J = 125 °C	–	29	–	
			T _J = 175 °C	–	37	–	
V _{G(th)}	Gate Threshold Voltage	V _{DS} = 5 V, I _D = 10 mA	4.0	4.8	6.0	V	
R _G	Gate Resistance	f = 1 MHz, open drain	–	4.5	–	Ω	

TYPICAL PERFORMANCE – REVERSE DIODE

I _S	Diode Continuous Forward Current (Note 1)	T _C = 25 °C	–	–	72	A
I _{S,pulse}	Diode Pulse Current (Note 2)	T _C = 25 °C	–	–	208	A
V _{FSD}	Forward Voltage	V _{GS} = 0 V, I _S = 20 A, T _J = 25 °C	–	1.14	1.46	V
		V _{GS} = 0 V, I _S = 20 A, T _J = 175 °C	–	1.35	–	
Q _{rr}	Reverse Recovery Charge	V _{DS} = 400 V, I _S = 50 A, V _{GS} = 0 V, R _{G,EXT} = 50 Ω, di/dt = 1400 A/μs, T _J = 25 °C	–	125	–	nC
t _{rr}	Reverse Recovery Time	V _{DS} = 400 V, I _S = 50 A, V _{GS} = 0 V, R _{G,EXT} = 50 Ω, di/dt = 1400 A/μs, T _J = 25 °C	–	12.5	–	ns
Q _{rr}	Reverse Recovery Charge	V _{DS} = 400 V, I _S = 50 A, V _{GS} = 0 V, R _{G,EXT} = 50 Ω, di/dt = 1400 A/μs, T _J = 150 °C	–	128	–	nC
t _{rr}	Reverse Recovery Time	V _{DS} = 400 V, I _S = 50 A, V _{GS} = 0 V, R _{G,EXT} = 50 Ω, di/dt = 1400 A/μs, T _J = 150 °C	–	14.4	–	ns

TYPICAL PERFORMANCE – DYNAMIC

C _{iss}	Input Capacitance	V _{DS} = 400 V, V _{GS} = 0 V, f = 100 kHz	–	1414	–	pF
C _{oss}	Output Capacitance		–	118	–	
C _{rss}	Reverse Transfer Capacitance		–	2.0	–	
C _{oss(er)}	Effective Output Capacitance, Energy Related	V _{DS} = 0 V to 400 V, V _{GS} = 0 V	–	150	–	pF
C _{oss(tr)}	Effective Output Capacitance, Time Related		–	280	–	pF
E _{oss}	C _{oss} Stored Energy	V _{DS} = 400 V, V _{GS} = 0 V	–	12	–	μJ
Q _G	Total Gate Charge	V _{DS} = 400 V, I _D = 50 A, V _{GS} = 0 V to 15 V	–	37.8	–	nC
Q _{GD}	Gate-Drain Charge		–	8.0	–	
Q _{GS}	Gate-Source Charge		–	11.8	–	
t _{d(on)}	Turn-on Delay Time	Note 4 V _{DS} = 400 V, I _D = 50 A, Gate Driver = 0 V, to +15 V, Turn-on R _{G,EXT} = 1 Ω, Turn-off R _{G,EXT} = 50 Ω, Inductive Load,	–	13	–	ns
t _r	Rise Time		–	23	–	
t _{d(off)}	Turn-off Delay Time		–	136	–	
t _f	Fall Time		–	17.6	–	
E _{ON}	Turn-on Energy	FWD: same device with V _{GS} = 0 V and R _G = 50 Ω, T _J = 25 °C	–	209	–	μJ
E _{OFF}	Turn-off Energy		–	212	–	
E _{TOTAL}	Total Switching Energy		–	421	–	

UJ4SC075018B7S

ELECTRICAL CHARACTERISTICS ($T_J = +25\text{ }^\circ\text{C}$ unless otherwise specified) (continued)

Symbol	Parameter	Test Conditions	Min	Typ	Max	Unit
TYPICAL PERFORMANCE – DYNAMIC						
$t_{d(on)}$	Turn-on Delay Time	Note 4 $V_{DS} = 400\text{ V}$, $I_D = 50\text{ A}$, Gate Driver = 0 V , to $+15\text{ V}$, Turn-on $R_{G,EXT} = 1\ \Omega$, Turn-off $R_{G,EXT} = 50\ \Omega$, Inductive Load, FWD: same device with $V_{GS} = 0\text{ V}$ and $R_G = 50\ \Omega$, $T_J = 150\text{ }^\circ\text{C}$	–	10.5	–	ns
t_r	Rise Time		–	26	–	
$t_{d(off)}$	Turn-off Delay Time		–	146	–	
t_f	Fall Time		–	20	–	
E_{ON}	Turn-on Energy		–	245	–	μJ
E_{OFF}	Turn-off Energy		–	248	–	
E_{TOTAL}	Total Switching Energy	–	493	–		
$t_{d(on)}$	Turn-on Delay Time	Notes 5 and 6 $V_{DS} = 400\text{ V}$, $I_D = 50\text{ A}$, Gate Driver = 0 V , to $+15\text{ V}$, $R_{G,EXT} = 1\ \Omega$, Inductive Load, FWD: same device with $V_{GS} = 0\text{ V}$ and $R_G = 1\ \Omega$, RC snubber: $R_S = 10\ \Omega$ and $C_S = 300\text{ pF}$, $T_J = 25\text{ }^\circ\text{C}$	–	19	–	ns
t_r	Rise Time		–	27	–	
$t_{d(off)}$	Turn-off Delay Time		–	41.6	–	
t_f	Fall Time		–	10.4	–	
E_{ON}	Turn-on Energy Including R_S Energy		–	169	–	μJ
E_{OFF}	Turn-off Energy Including R_S Energy		–	149	–	
E_{TOTAL}	Total Switching Energy		–	318	–	
E_{RS_ON}	Snubber R_S Energy During Turn-on		–	5	–	
E_{RS_OFF}	Snubber R_S Energy During Turn-off		–	8.5	–	
$t_{d(on)}$	Turn-on Delay Time		Notes 5 and 6 $V_{DS} = 400\text{ V}$, $I_D = 50\text{ A}$, Gate Driver = 0 V , to $+15\text{ V}$, $R_{G,EXT} = 1\ \Omega$, Inductive Load, FWD: same device with $V_{GS} = 0\text{ V}$ and $R_G = 1\ \Omega$, RC snubber: $R_S = 10\ \Omega$ and $C_S = 300\text{ pF}$, $T_J = 150\text{ }^\circ\text{C}$	–	17	
t_r	Rise Time	–		29	–	
$t_{d(off)}$	Turn-off Delay Time	–		41	–	
t_f	Fall Time	–		9	–	
E_{ON}	Turn-on Energy Including R_S Energy	–		198	–	μJ
E_{OFF}	Turn-off Energy Including R_S Energy	–		153	–	
E_{TOTAL}	Total Switching Energy	–		351	–	
E_{RS_ON}	Snubber R_S Energy During Turn-on	–		5	–	
E_{RS_OFF}	Snubber R_S Energy During Turn-off	–		7	–	

Product parametric performance is indicated in the Electrical Characteristics for the listed test conditions, unless otherwise noted. Product performance may not be indicated by the Electrical Characteristics if operated under different conditions.

4. Measured with the switching test circuit in Figure 23.

5. Measured with the switching test circuit in Figure 24.

6. In this datasheet, all the switching energies (turn-on energy, turn-off energy and total energy) presented in the tables and Figures include the device RC snubber energy losses.

TYPICAL CHARACTERISTICS

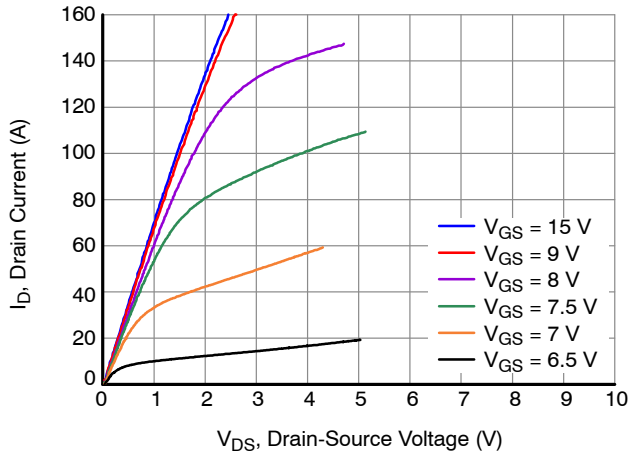

Figure 1. Typical Output Characteristics at $T_J = -55\text{ }^\circ\text{C}$, $t_p < 250\text{ }\mu\text{s}$

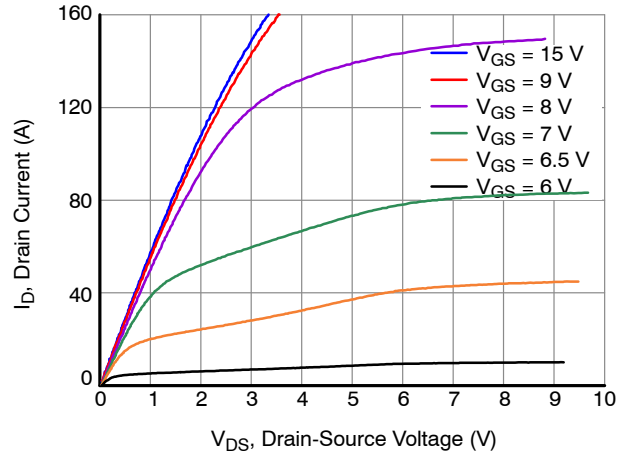

Figure 2. Typical Output Characteristics at $T_J = 25\text{ }^\circ\text{C}$, $t_p < 250\text{ }\mu\text{s}$

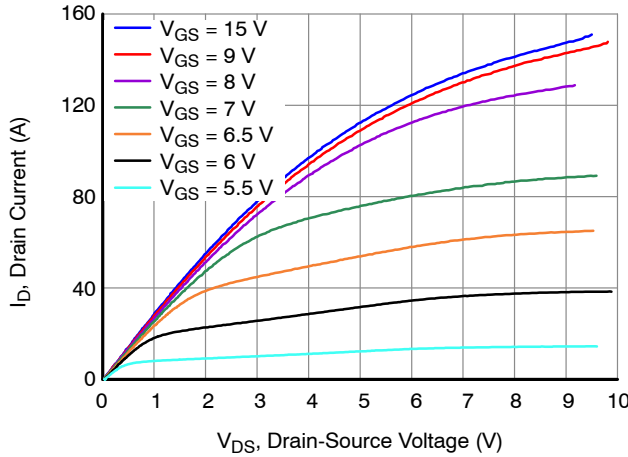

Figure 3. Typical Output Characteristics at $T_J = 175\text{ }^\circ\text{C}$, $t_p < 250\text{ }\mu\text{s}$

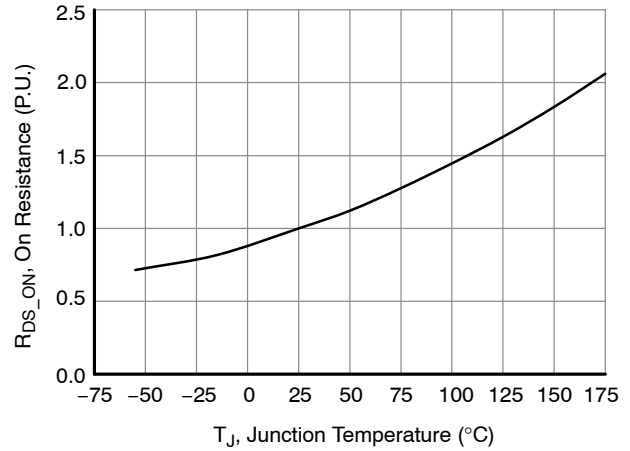

Figure 4. Normalized On-Resistance vs. Temperature at $V_{GS} = 12\text{ V}$ and $I_D = 50\text{ A}$

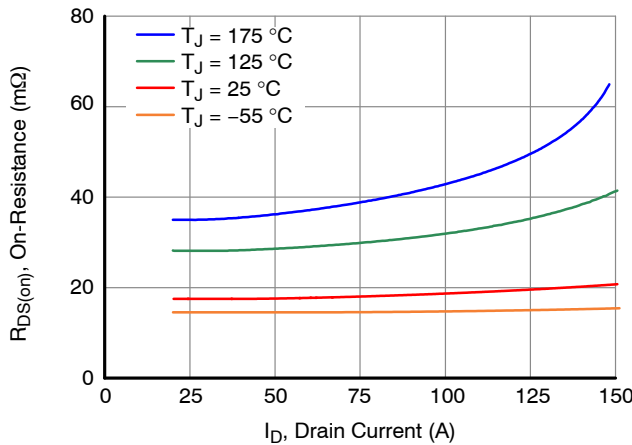

Figure 5. Typical Drain-Source On-Resistances at $V_{GS} = 12\text{ V}$

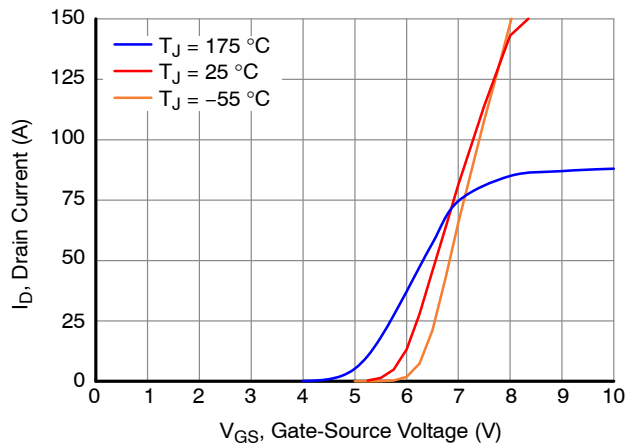

Figure 6. Typical Transfer Characteristics at $V_{DS} = 5\text{ V}$

TYPICAL CHARACTERISTICS (continued)

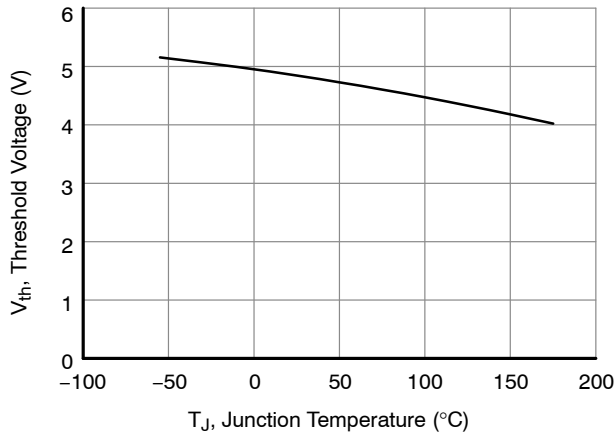

Figure 7. Threshold Voltage vs. Junction Temperature at $V_{DS} = 5\text{ V}$ and $I_D = 10\text{ mA}$

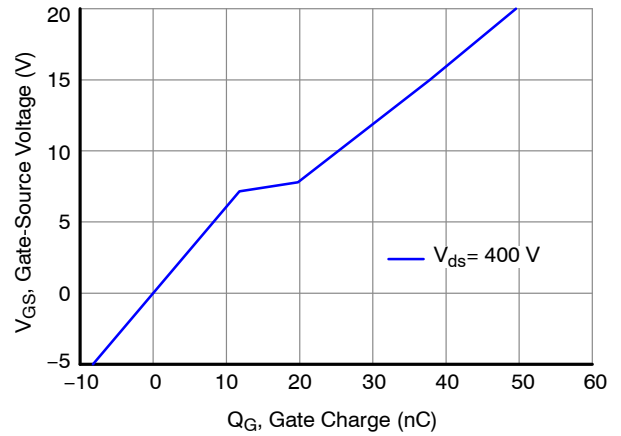

Figure 8. Typical Gate Charge at $I_D = 50\text{ A}$

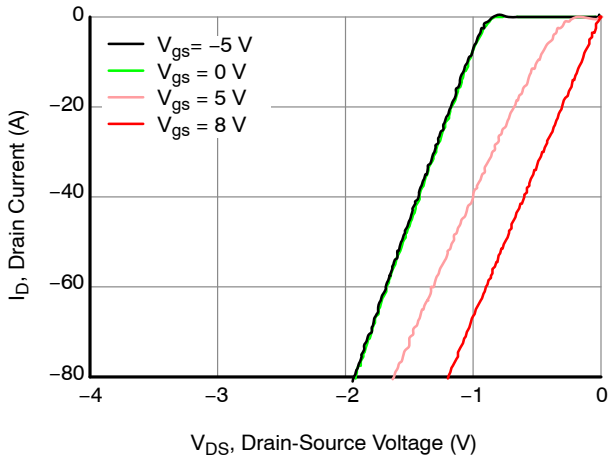

Figure 9. 3rd Quadrant Characteristics at $T_J = -55\text{ °C}$

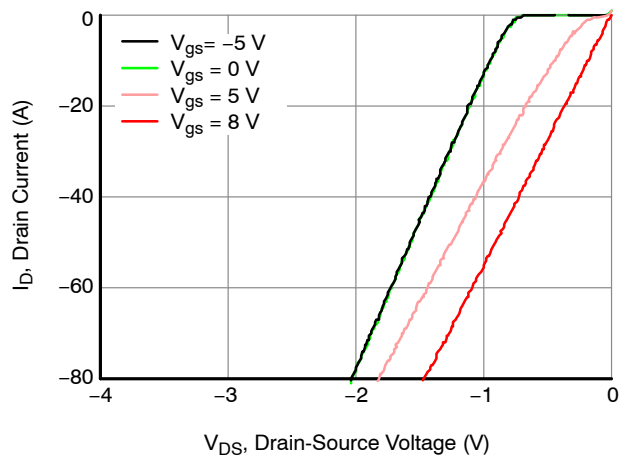

Figure 10. 3rd Quadrant Characteristics at $T_J = 25\text{ °C}$

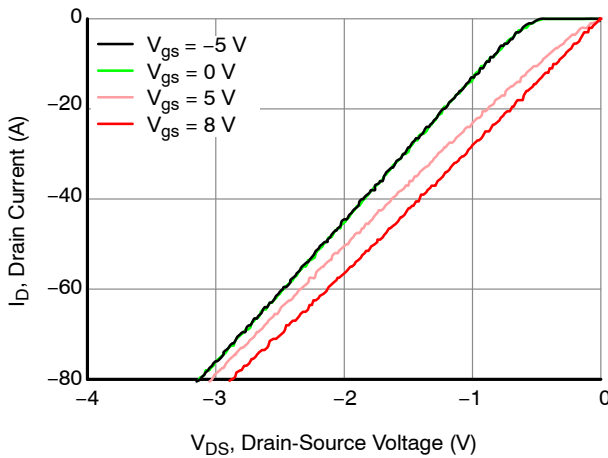

Figure 11. 3rd Quadrant Characteristics at $T_J = 175\text{ °C}$

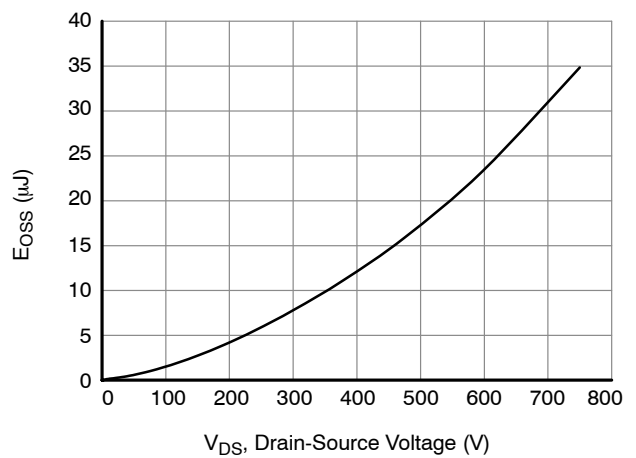

Figure 12. Typical Stored Energy in C_{OSS} at $V_{GS} = 0\text{ V}$

TYPICAL CHARACTERISTICS (continued)

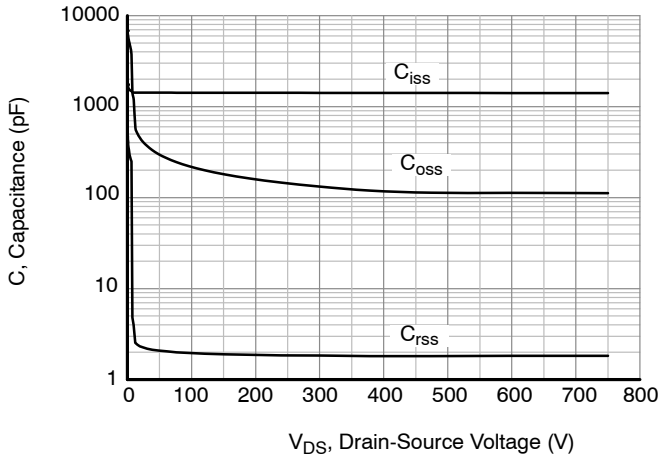

Figure 13. Typical Capacitances at $f = 100 \text{ kHz}$ and $V_{GS} = 0 \text{ V}$

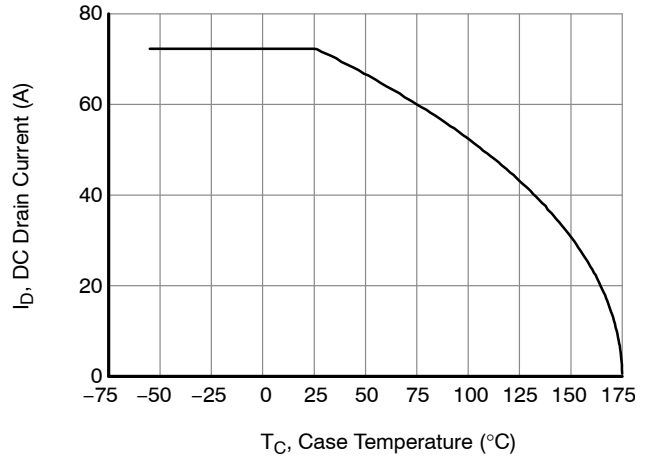

Figure 14. DC Drain Current Derating

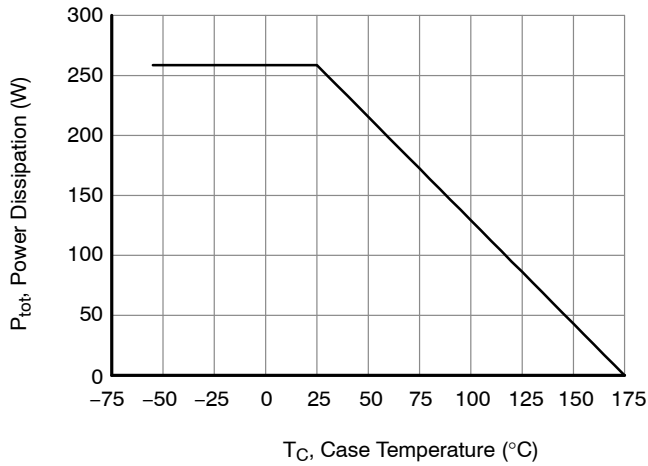

Figure 15. Total Power Dissipation

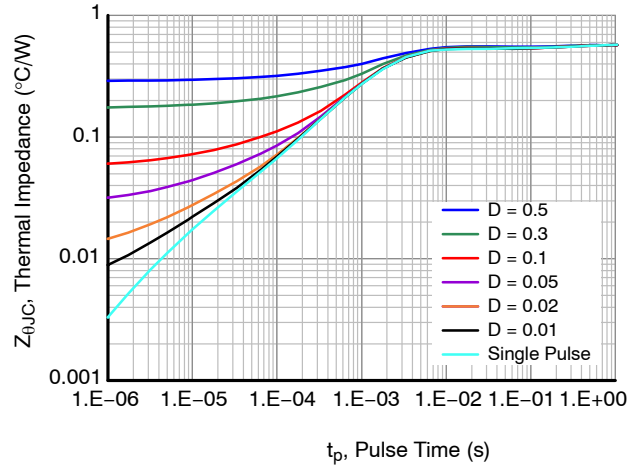

Figure 16. Maximum Transient Thermal Impedance

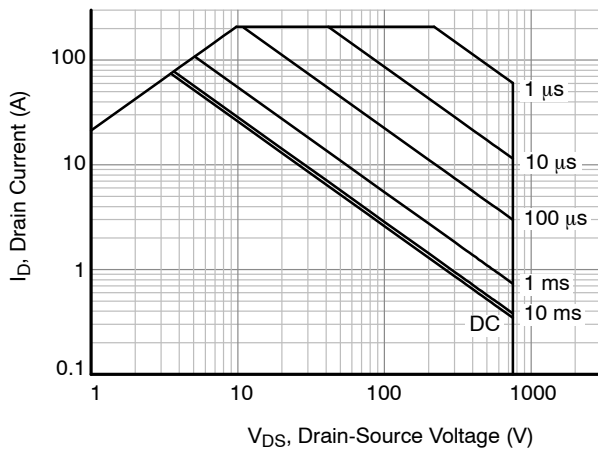

Figure 17. Safe Operation Area at $T_C = 25 \text{ }^\circ\text{C}$, $D = 0$, Parameter t_p

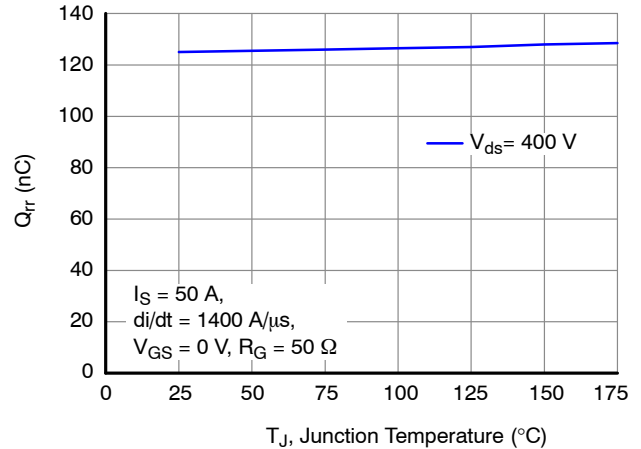

Figure 18. Reverse Recovery Charge Q_{rr} vs. Junction Temperature at $V_{DS} = 400 \text{ V}$

TYPICAL CHARACTERISTICS (continued)

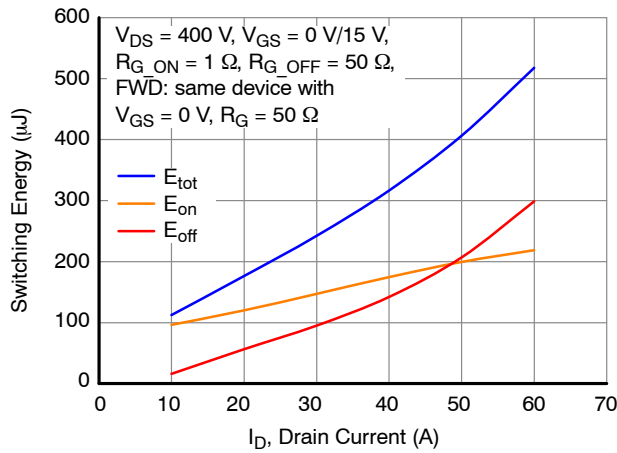

Figure 19. Clamped Inductive Switching Energy vs. Drain Current at $V_{DS} = 400\text{ V}$ and $T_J = 25\text{ }^\circ\text{C}$

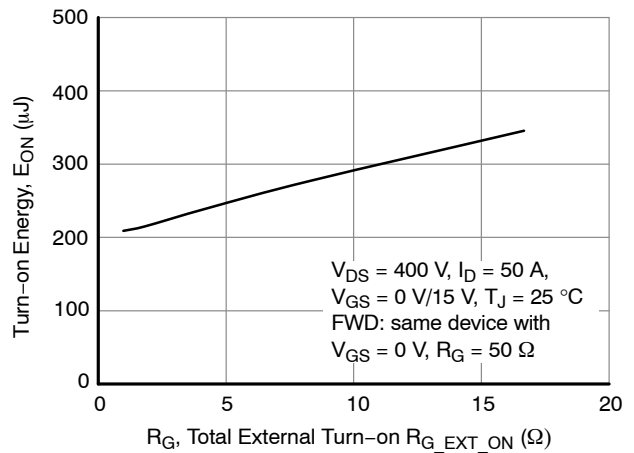

Figure 20. Clamped Inductive Switching Turn-On Energy vs. $R_{G_EXT_ON}$

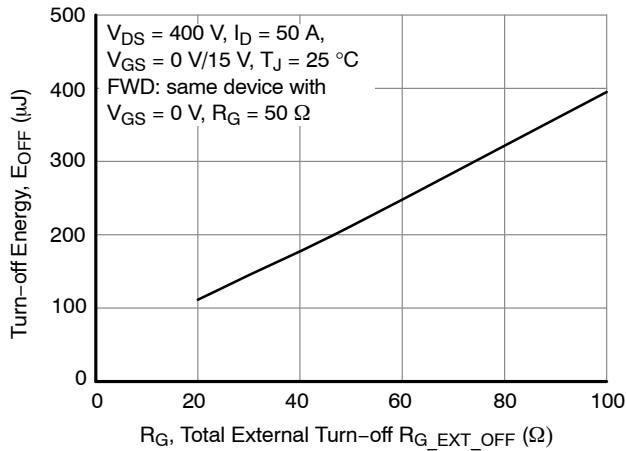

Figure 21. Clamped Inductive Switching Turn-Off Energy vs. $R_{G_EXT_OFF}$

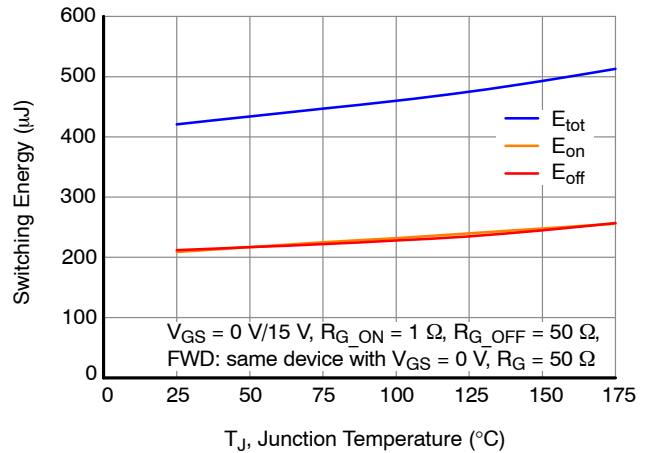

Figure 22. Clamped Inductive Switching Energy vs. Junction Temperature at $V_{DS} = 400\text{ V}$ and $I_D = 50\text{ A}$

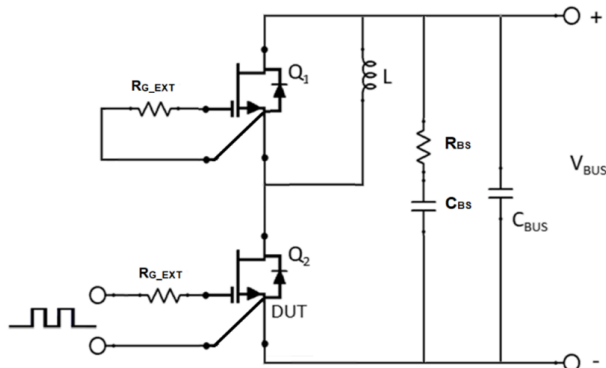

Figure 23. Schematic of the Half-Bridge Mode Switching Test Circuit. Note, a Bus RC Snubber ($R_{BS} = 2.5\text{ }\Omega$, $C_{BS} = 100\text{ nF}$) is Used to Reduce the Power Loop High Frequency Oscillations.

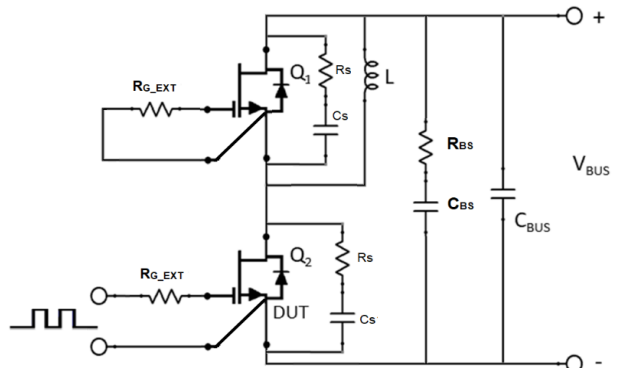

Figure 24. Schematic of the Half-Bridge Mode Switching Test Circuit with device RC Snubbers ($R_S = 10\text{ }\Omega$, $C_S = 300\text{ pF}$) and a Bus RC Snubber ($R_{BS} = 2.5\text{ }\Omega$, $C_{BS} = 100\text{ nF}$).

UJ4SC075018B7S

APPLICATIONS INFORMATION

SiC FETs are enhancement-mode power switches formed by a high-voltage SiC depletion-mode JFET and a low-voltage silicon MOSFET connected in series. The silicon MOSFET serves as the control unit while the SiC JFET provides high voltage blocking in the off state. This combination of devices in a single package provides compatibility with standard gate drivers and offers superior performance in terms of low on-resistance ($R_{DS(on)}$), output capacitance (C_{oss}), gate charge (Q_G), and reverse recovery charge (Q_{rr}) leading to low conduction and switching losses. The SiC FETs also provide excellent reverse conduction capability eliminating the need for an external anti-parallel diode.

Like other high performance power switches, proper PCB layout design to minimize circuit parasitics is strongly recommended due to the high dv/dt and di/dt rates. An external gate resistor is recommended when the FET is

working in the diode mode in order to achieve the optimum reverse recovery performance. For more information on SiC FET operation, see www.onsemi.com.

A snubber circuit with a small $R_{(G)}$, or gate resistor, provides better EMI suppression with higher efficiency compared to using a high $R_{(G)}$ value. There is no extra gate delay time when using the snubber circuitry, and a small $R_{(G)}$ will better control both the turn-off $V_{(DS)}$ peak spike and ringing duration, while a high $R_{(G)}$ will damp the peak spike but result in a longer delay time. In addition, the total switching loss when using a snubber circuit is less than using high $R_{(G)}$, while greatly reducing $E_{(OFF)}$ from mid-to-full load range with only a small increase in $E_{(ON)}$. Efficiency will therefore improve with higher load current. For more information on how a snubber circuit will improve overall system performance, visit the **onsemi** website at www.onsemi.com.

ORDERING INFORMATION

Part Number	Marking	Package	Shipping†
UJ4SC075018B7S	UJ4SC075018B7S	TO-263-7 (Pb-Free, Halogen Free)	800 units / Tape and Reel

†For information on tape and reel specifications, including part orientation and tape sizes, please refer to our Tape and Reel Packaging Specifications Brochure, [BRD8011/D](http://www.onsemi.com).

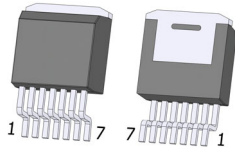

TO-263-7 10.18x9.08x4.43, 1.27P
CASE 418BA
ISSUE B

DATE 17 APR 2025

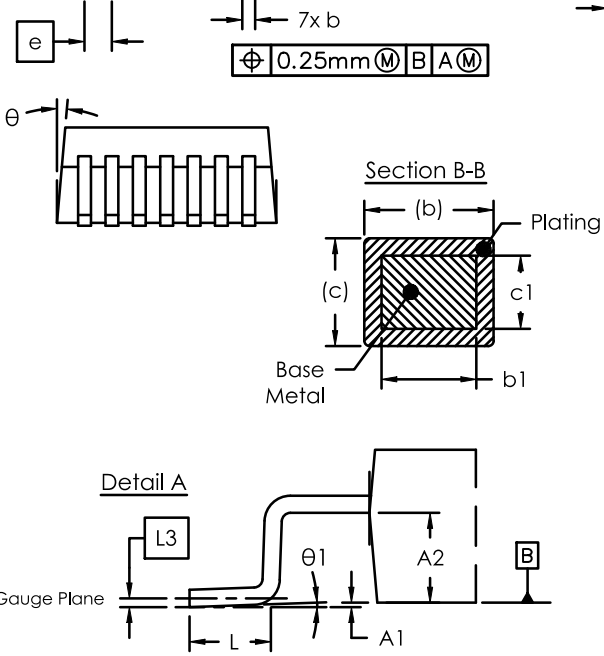
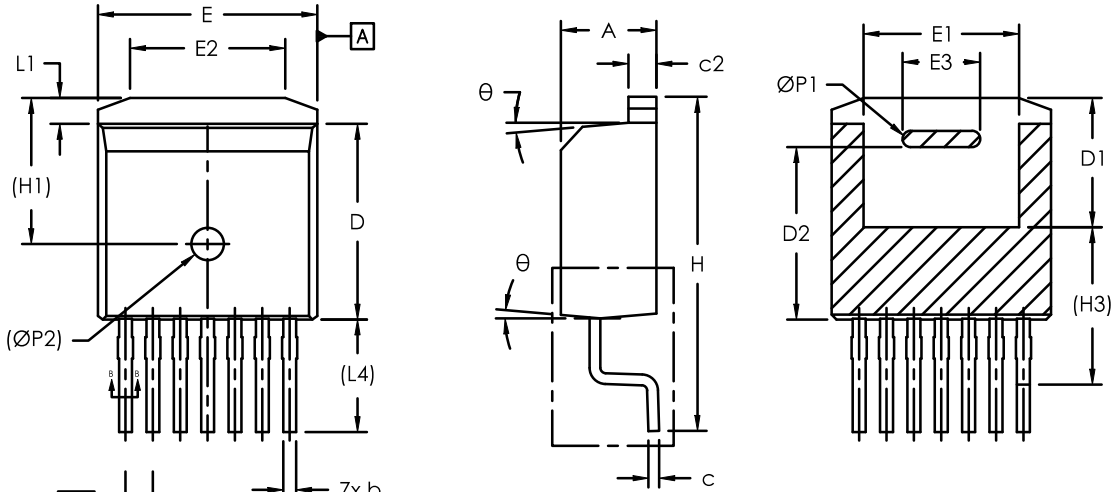

SYM	MILLIMETERS		
	Min	Nom	Max
A	4.30	4.43	4.56
A1	0.00	0.13	0.25
A2	2.45	2.60	2.75
b	0.50	0.60	0.70
b1	0.50	-	-
c	0.40	0.50	0.60
c1	0.40	-	-
c2	1.20	1.30	1.40
D	8.93	9.08	9.23
D1	5.85	6.00	6.15
D2	7.90	8.00	8.10
e	1.27 BSC		
E	10.08	10.18	10.28
E1	6.82	7.22	7.62
E2	6.50	7.55	8.60
E3	3.50	3.60	3.70
H	15.00	15.50	16.00
H1	6.78 REF		
H3	7.30 REF.		
L	1.90	2.20	2.50
L1	0.98	1.20	1.42
L3	0.25 BSC		
L4	5.22 REF		
ØP1	0.65	0.75	0.85
ØP2	1.50 REF		
θ	5°		
θ1	3°		

Notes:

1. Dimensioning and Tolerancing as per ASME Y14.5M, 2018.
2. Controlling Dimension : Millimeters
3. Package body sides exclude mold flash and gate burrs.
4. Dimension L is measured on gauge plane.
5. Dimension c1 and b1 applies to base metal only.

DOCUMENT NUMBER:	98AON13800G	Electronic versions are uncontrolled except when accessed directly from the Document Repository. Printed versions are uncontrolled except when stamped "CONTROLLED COPY" in red.
DESCRIPTION:	TO-263-7 10.18x9.08x4.43, 1.27P	PAGE 1 OF 2

onsemi and ONSEMI are trademarks of Semiconductor Components Industries, LLC dba onsemi or its subsidiaries in the United States and/or other countries. onsemi reserves the right to make changes without further notice to any products herein. onsemi makes no warranty, representation or guarantee regarding the suitability of its products for any particular purpose, nor does onsemi assume any liability arising out of the application or use of any product or circuit, and specifically disclaims any and all liability, including without limitation special, consequential or incidental damages. onsemi does not convey any license under its patent rights nor the rights of others.

RECOMMENDED PCB FOOTPRINT

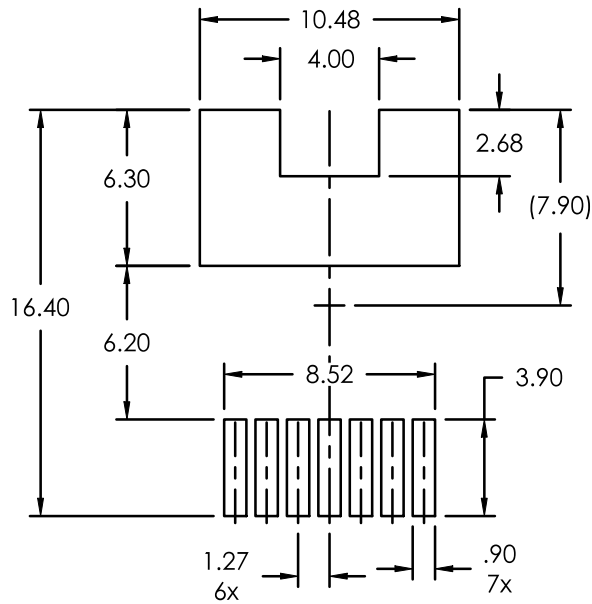

RECOMMENDED STENCIL APERTURE

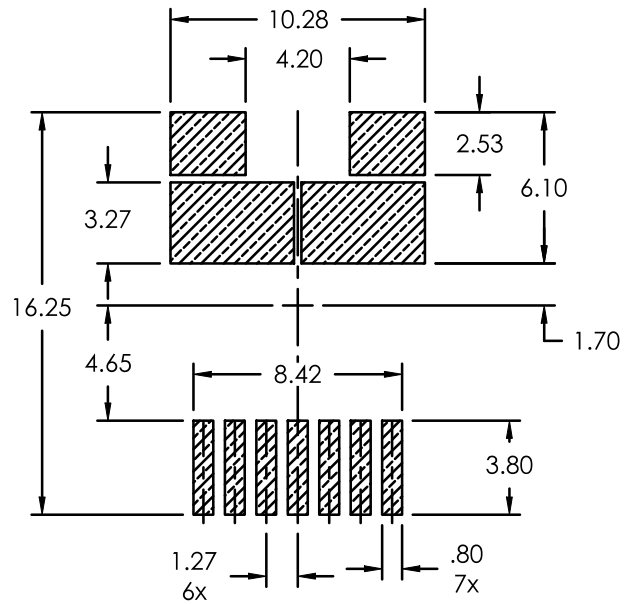

NOTE: LAND PATTERN AND STENCIL APERTURE DIMENSIONS SERVE ONLY AS AN INITIAL GUIDE. END-USER PCB DESIGN RULES AND TOLERANCES SHOULD ALWAYS PREVAIL.

PCB FOOTPRINT with PACKAGE OVERLAY

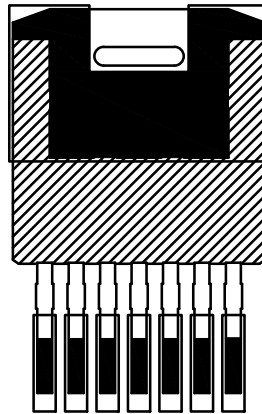

- AREA IN CONTACT WITH THE PACKAGE
- MOLD COMPOUND

DOCUMENT NUMBER:	98AON13800G	Electronic versions are uncontrolled except when accessed directly from the Document Repository. Printed versions are uncontrolled except when stamped "CONTROLLED COPY" in red.
DESCRIPTION:	TO-263-7 10.18x9.08x4.43, 1.27P	PAGE 2 OF 2

onsemi and **ONSEMI** are trademarks of Semiconductor Components Industries, LLC dba **onsemi** or its subsidiaries in the United States and/or other countries. **onsemi** reserves the right to make changes without further notice to any products herein. **onsemi** makes no warranty, representation or guarantee regarding the suitability of its products for any particular purpose, nor does **onsemi** assume any liability arising out of the application or use of any product or circuit, and specifically disclaims any and all liability, including without limitation special, consequential or incidental damages. **onsemi** does not convey any license under its patent rights nor the rights of others.

onsemi, **Onsemi**, and other names, marks, and brands are registered and/or common law trademarks of Semiconductor Components Industries, LLC dba "**onsemi**" or its affiliates and/or subsidiaries in the United States and/or other countries. **onsemi** owns the rights to a number of patents, trademarks, copyrights, trade secrets, and other intellectual property. A listing of **onsemi**'s product/patent coverage may be accessed at www.onsemi.com/site/pdf/Patent-Marking.pdf. **onsemi** reserves the right to make changes at any time to any products or information herein, without notice. The information herein is provided "as-is" and **onsemi** makes no warranty, representation or guarantee regarding the accuracy of the information, product features, availability, functionality, or suitability of its products for any particular purpose, nor does **onsemi** assume any liability arising out of the application or use of any product or circuit, and specifically disclaims any and all liability, including without limitation special, consequential or incidental damages. Buyer is responsible for its products and applications using **onsemi** products, including compliance with all laws, regulations and safety requirements or standards, regardless of any support or applications information provided by **onsemi**. "Typical" parameters which may be provided in **onsemi** data sheets and/or specifications can and do vary in different applications and actual performance may vary over time. All operating parameters, including "Typicals" must be validated for each customer application by customer's technical experts. **onsemi** does not convey any license under any of its intellectual property rights nor the rights of others. **onsemi** products are not designed, intended, or authorized for use as a critical component in life support systems or any FDA Class 3 medical devices or medical devices with a same or similar classification in a foreign jurisdiction or any devices intended for implantation in the human body. Should Buyer purchase or use **onsemi** products for any such unintended or unauthorized application, Buyer shall indemnify and hold **onsemi** and its officers, employees, subsidiaries, affiliates, and distributors harmless against all claims, costs, damages, and expenses, and reasonable attorney fees arising out of, directly or indirectly, any claim of personal injury or death associated with such unintended or unauthorized use, even if such claim alleges that **onsemi** was negligent regarding the design or manufacture of the part. **onsemi** is an Equal Opportunity/Affirmative Action Employer. This literature is subject to all applicable copyright laws and is not for resale in any manner.

ADDITIONAL INFORMATION

TECHNICAL PUBLICATIONS:

Technical Library: www.onsemi.com/design/resources/technical-documentation
onsemi Website: www.onsemi.com

ONLINE SUPPORT: www.onsemi.com/support

For additional information, please contact your local Sales Representative at www.onsemi.com/support/sales

