

Silicon Carbide (SiC) JFET – EliteSiC, Power N-Channel, TO247-3, 650 V, 25 mohm

UJ3N065025K3S

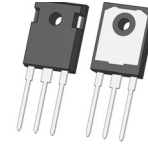

TO247-3
 CASE 340AK

Description

onsemi offers the High-Performance G3 SiC normally-On JFET transistors. This Series Exhibits Ultra-low on resistance ($R_{DS(ON)}$) and Gate charge (Q_G) allowing for Low Conduction and Switching loss. The device Normally-On Characteristics with low $R_{DS(ON)}$ at $V_{GS} = 0$ V is also ideal for current protection circuits without the need for active control, as well as for cascode operation.

Features

- Typical On-Resistance $R_{DS(on)}$, typ of 25 m Ω
- Voltage Controlled
- Maximum Operating Temperature of 175 °C
- Extremely Fast Switching not Dependent on Temperature
- Low Gate Charge
- Low Intrinsic Capacitance
- This Device is Pb-Free, Halogen Free and is RoHS Compliant

Typical Applications

- Over Current Protection Circuits
- DC-AC Inverters
- Switch Mode Power Supplies
- Power Factor Correction Modules
- Motor Drives
- Induction Heating

MARKING DIAGRAM

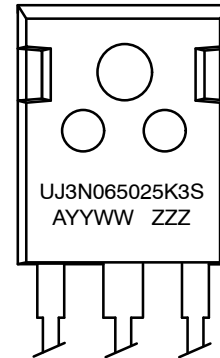

UJ3N065025K3S = Specific Device Code
 A = Assembly Location
 YY = Year
 WW = Work Week
 ZZZ = Lot ID

PIN CONNECTIONS

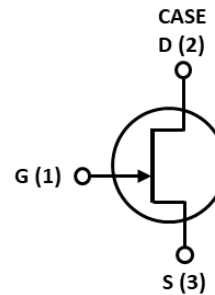

ORDERING INFORMATION

See detailed ordering and shipping information on page 7 of this data sheet.

MAXIMUM RATINGS

Parameter	Symbol	Test Conditions	Value	Unit
Drain-source Voltage	V_{DS}		650	V
Gate-Source Voltage	V_{GS}	DC	-20 to +3	V
		AC (Note 1)	-20 to +20	
Continuous Drain Current (Note 2)	I_D	$T_C = 25\text{ }^\circ\text{C}$	85	A
		$T_C = 100\text{ }^\circ\text{C}$	62	A
Pulsed Drain Current (Note 3)	I_{DM}	$T_C = 25\text{ }^\circ\text{C}$	250	A
Power Dissipation	P_{TOT}	$T_C = 25\text{ }^\circ\text{C}$	441	W
Maximum Junction Temperature	$T_{J,max}$		175	$^\circ\text{C}$
Operating and Storage Temperature	T_J, T_{STG}		-55 to 175	$^\circ\text{C}$
Max. Lead Temperature for Soldering, 1/8" from Case for 5 seconds	T_L		250	$^\circ\text{C}$

Stresses exceeding those listed in the Maximum Ratings table may damage the device. If any of these limits are exceeded, device functionality should not be assumed, damage may occur and reliability may be affected.

- +20 V AC Rating Applies for Turn-on Pulses <200 ns applied with external $R_G > 1\ \Omega$
- Limited by $T_{J,max}$
- Pulse width t_p limited by $T_{J,max}$

THERMAL CHARACTERISTICS

Parameter	Symbol	Test Conditions	Value			
			Min	Typ	Max	Unit
Thermal Resistance, Junction-to-Case	$R_{\theta JC}$		-	0.26	0.34	$^\circ\text{C/W}$

UJ3N065025K3S

ELECTRICAL CHARACTERISTICS (T_J = +25 °C Unless otherwise specified)

Parameter	Symbol	Test Conditions	Min	Typ	Max	Unit
TYPICAL PERFORMANCE – STATIC						
Drain-Source Breakdown Voltage	BV _{DS}	V _{GS} = -20 V, I _D = 1 mA	650	-	-	V
Total Drain Leakage Current	I _D	V _{DS} = 650 V, V _{GS} = -20 V, T _J = 25 °C	-	10	60	μA
		V _{DS} = 650 V, V _{GS} = -20 V, T _J = 175 °C	-	40	-	
Total Gate Leakage Current	I _G	V _{GS} = -20 V, T _J = 25 °C	-	10	100	μA
		V _{GS} = -20 V, T _J = 175 °C	-	38	-	μA
Drain-Source On-Resistance	R _{DS(on)}	V _{GS} = 2 V, I _D = 20 A, T _J = 25 °C	-	22	-	mΩ
		V _{GS} = 0 V, I _D = 20 A, T _J = 25 °C	-	25	33	
		V _{GS} = 2 V, I _D = 20 A, T _J = 175 °C	-	38	-	
		V _{GS} = 0 V, I _D = 20 A, T _J = 175 °C	-	43	-	
Gate Threshold Voltage	V _{G(th)}	V _{DS} = 5 V, I _D = 70 mA	-14	-11.5	-6	V
Gate Resistance	R _G	f = 1 MHz, Open Drain	-	2.5	-	Ω

TYPICAL PERFORMANCE – DYNAMIC

Input Capacitance	C _{iss}	V _{DS} = 100 V, V _{GS} = -20 V, f = 100 kHz	-	2360	-	pF	
Output Capacitance	C _{oss}		-	290	-		
Reverse Transfer Capacitance	C _{rss}		-	282	-		
Effective Output Capacitance, Energy Related	C _{oss(er)}	V _{DS} = 0 V to 400 V, V _{GS} = -20 V	-	210	-	pF	
Total Gate Charge	Q _G	V _{DS} = 400 V, I _D = 60 A, V _{GS} = -18 V to 0 V	-	240	-	nC	
Gate-Drain Charge	Q _{GD}		-	134	-		
Gate-Source Charge	Q _{GS}		-	24	-		
Turn-On Delay Time	t _{d(on)}	V _{DS} = 400 V, I _D = 60 A, Gate Driver = -18 V to +0 V, R _{G, EXT} = 1 Ω, Inductive Load, FWD: UJ3D06530TS T _J = 25 °C	-	11	-	ns	
Rise Time	t _r		-	64	-		
Turn-Off Delay Time	t _{d(off)}		-	43	-		
Fall Time	t _f		-	44	-		
Turn-On Energy	E _{ON}		-	740	-	μJ	
Turn-Off Energy	E _{OFF}		-	818	-		
Total Switching Energy	E _{TOTAL}		-	1558	-		
Turn-On Delay Time	t _{d(on)}		V _{DS} = 400 V, I _D = 60 A, Gate Driver = -18 V to +0 V, R _{G, EXT} = 1 Ω, Inductive Load, FWD: UJ3D06530TS T _J = 150 °C	-	11	-	ns
Rise Time	t _r			-	62	-	
Turn-Off Delay Time	t _{d(off)}			-	38	-	
Fall Time	t _f	-		41	-		
Turn-On Energy	E _{ON}	-		663	-	μJ	
Turn-Off Energy	E _{OFF}	-		750	-		
Total Switching Energy	E _{TOTAL}	-		1413	-		

Product parametric performance is indicated in the Electrical Characteristics for the listed test conditions, unless otherwise noted. Product performance may not be indicated by the Electrical Characteristics if operated under different conditions.

TYPICAL PERFORMANCE DIAGRAMS

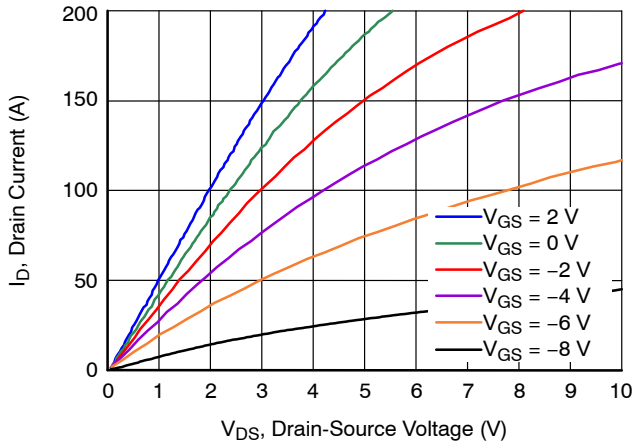

Figure 1. Typical Output Characteristics at $T_J = -55\text{ }^\circ\text{C}$

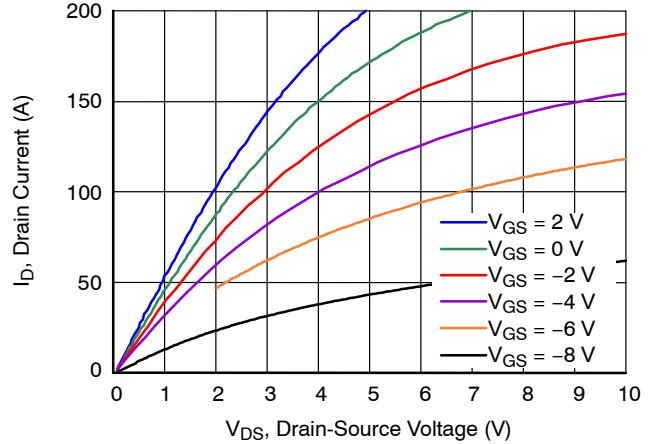

Figure 2. Typical Output Characteristics at $T_J = 25\text{ }^\circ\text{C}$

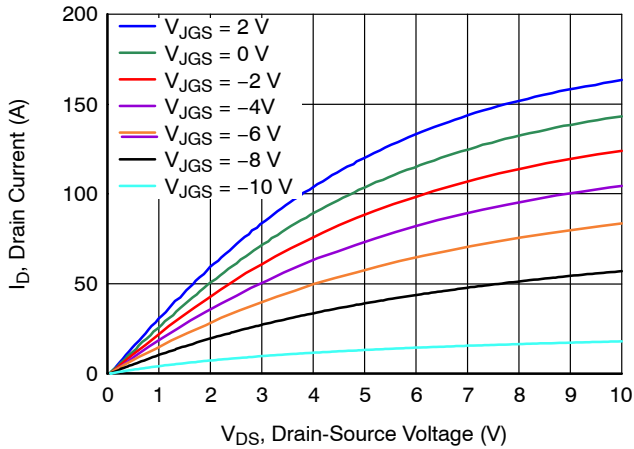

Figure 3. Typical Output Characteristics at $T_J = 175\text{ }^\circ\text{C}$

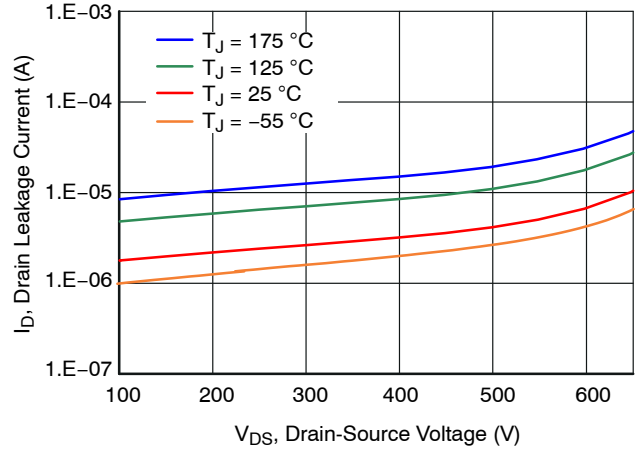

Figure 4. Typical Drain-Source Leakage at $V_{DS} = -20\text{ V}$

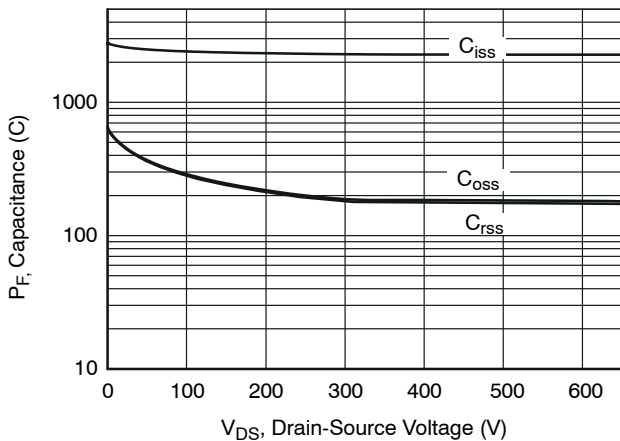

Figure 5. Typical Capacitances at 100 KHz and $V_{GS} = -20\text{ V}$

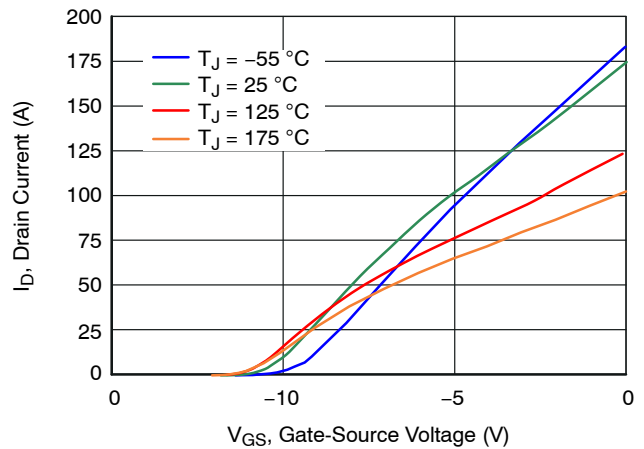

Figure 6. Typical Transfer Characteristics at $V_{DS} = 5\text{ V}$

TYPICAL PERFORMANCE DIAGRAMS (CONTINUED)

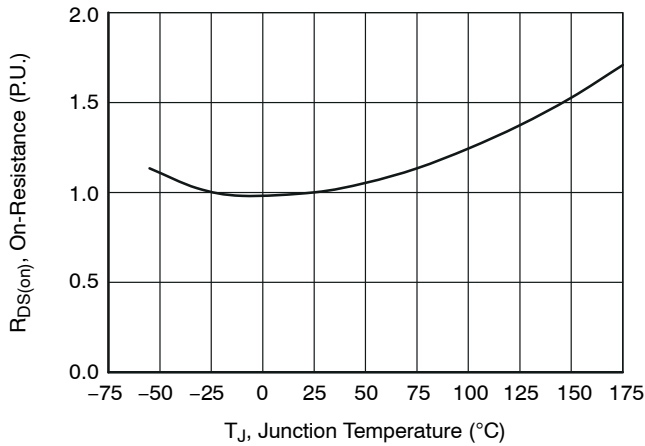

Figure 7. Normalized On-Resistance Vs. Temperature at $V_{GS} = 0\text{ V}$ and $I_D = 20\text{ A}$

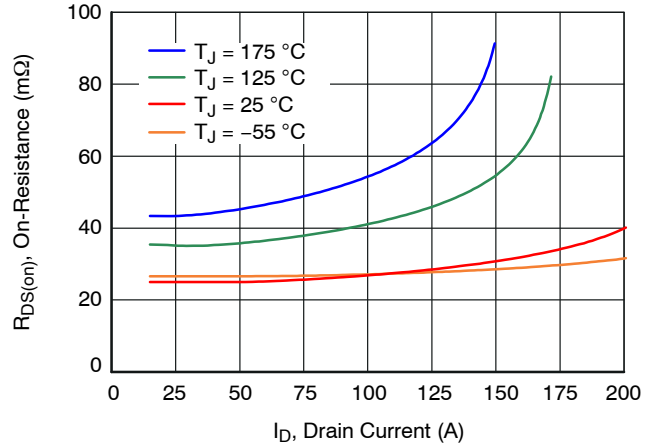

Figure 8. Typical Drain-Source On-Resistance $V_{GS} = 0\text{ V}$

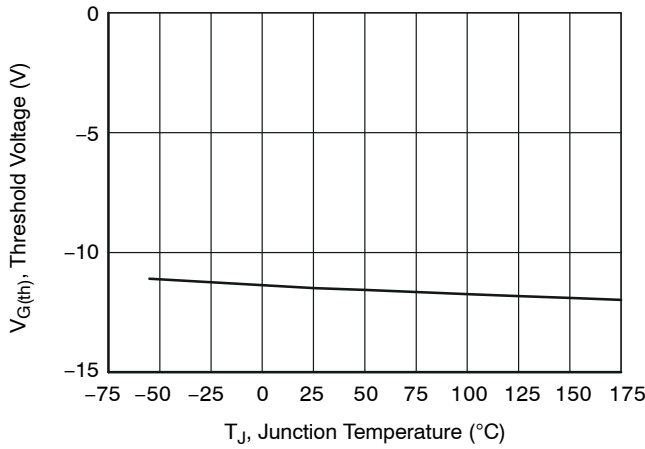

Figure 9. Threshold Voltage vs. T_J at $V_{DS} = 5\text{ V}$ and $I_D = 70\text{ mA}$

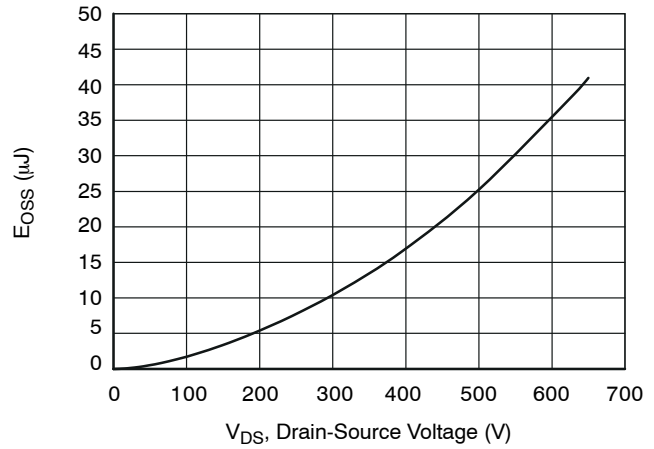

Figure 10. Typical Stored Energy in C_{OSS} at $V_{GS} = -20\text{ V}$

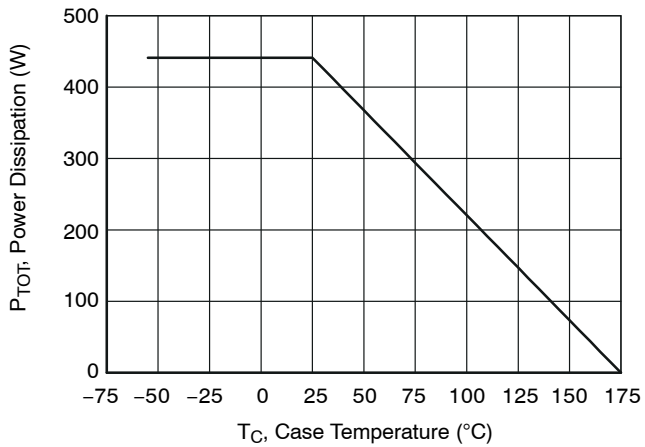

Figure 11. Total Power Dissipation

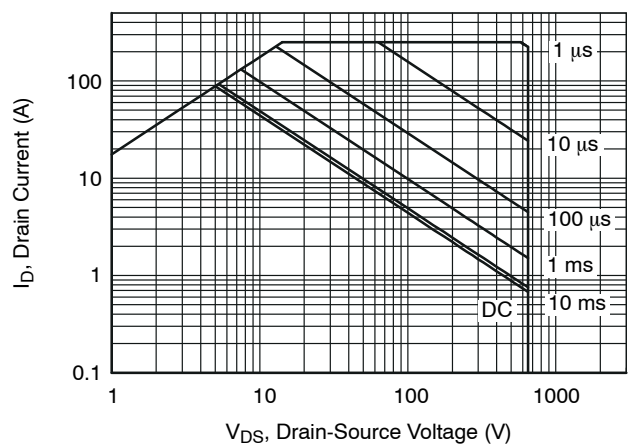

Figure 12. Safe Operation Area at $T_C = 25\text{ °C}$, Parameter t_p

TYPICAL PERFORMANCE DIAGRAMS (CONTINUED)

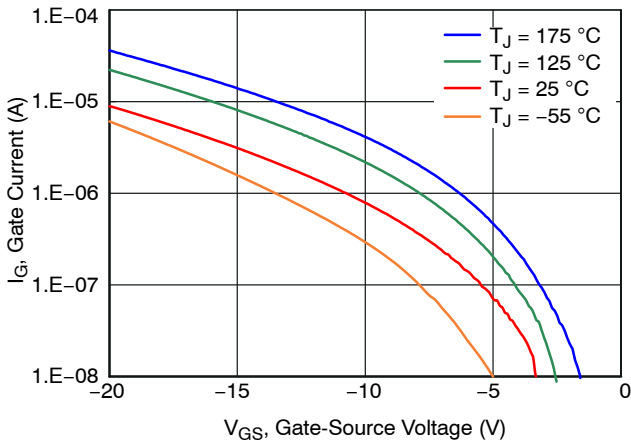

Figure 13. Typical Gate Leakage Current at $V_{DS} = 0\text{ V}$

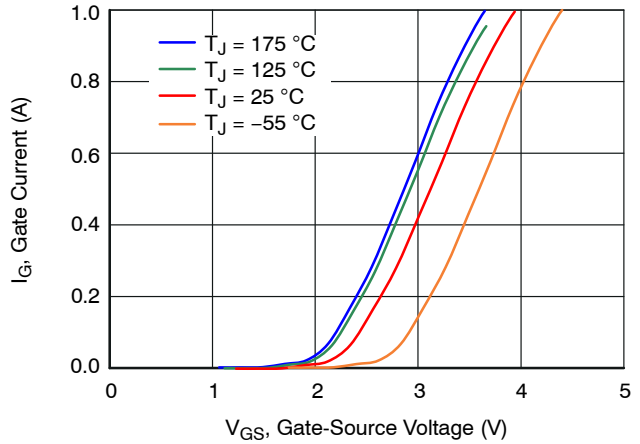

Figure 14. Typical Gate Forward Current at $V_{DS} = 0\text{ V}$

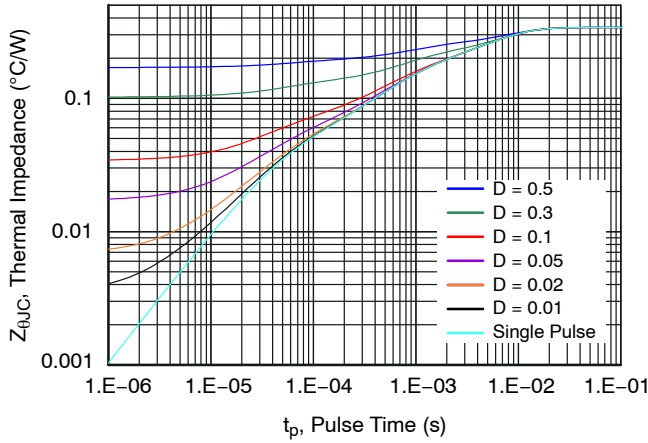

Figure 15. Maximum Transient Thermal Impedance

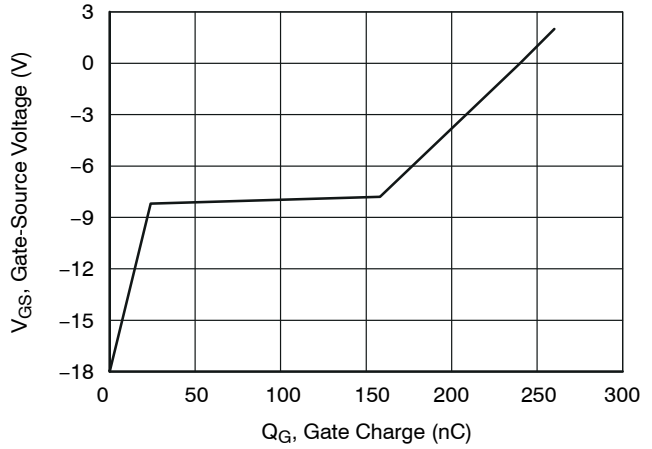

Figure 16. Typical Gate Charge at $V_{DS} = 400\text{ V}$ and $I_D = 60\text{ A}$

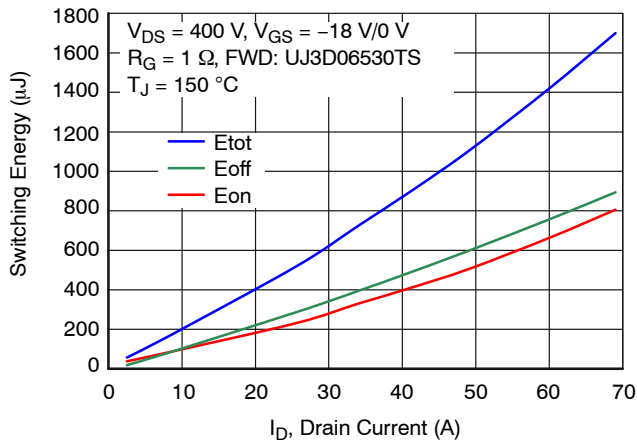

Figure 17. Clamped Inductive Switching Energy vs. Drain Current at $T_J = 150\text{ °C}$

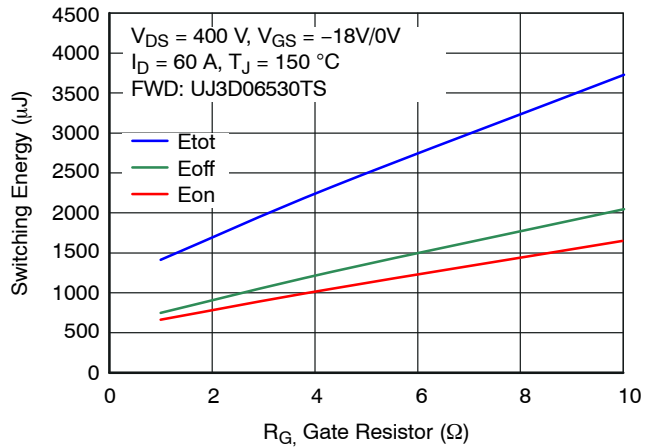

Figure 18. Clamped Inductive Switching Energy vs. Gate Resistor R_G

UJ3N065025K3S

TYPICAL PERFORMANCE DIAGRAMS (CONTINUED)

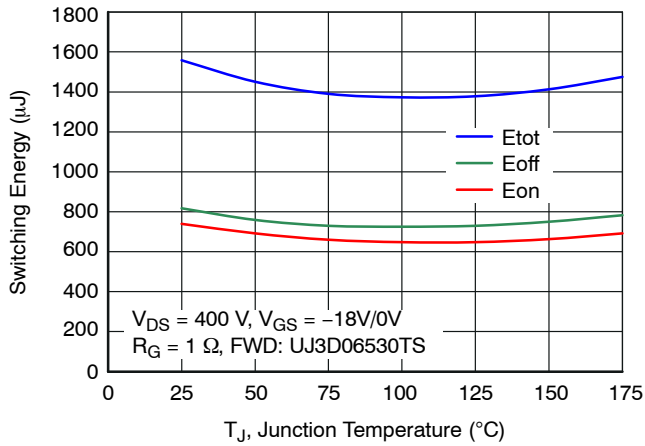
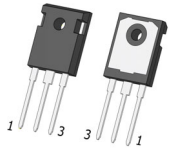

Figure 19. Clamped Inductive Switching Energy vs. Junction Temperature at $I_D = 60\text{ A}$

ORDERING INFORMATION

Part Number	Marking	Package	Shipping
UJ3N065025K3S	UJ3N065025K3S	TO247-3 (Pb-Free, Halogen Free)	600 Units / Tube



TO247-3 15.90x20.96x5.03, 5.44P
CASE 340AK
ISSUE B

DATE 14 APR 2025

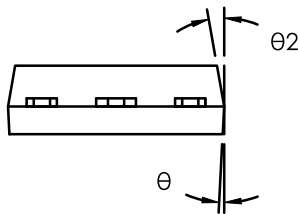
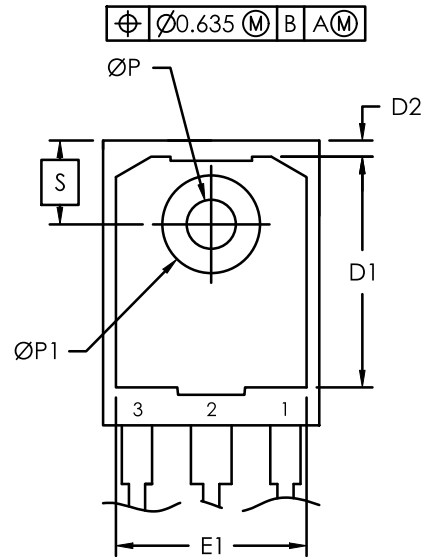
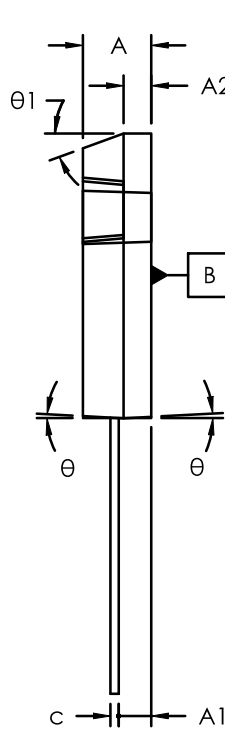
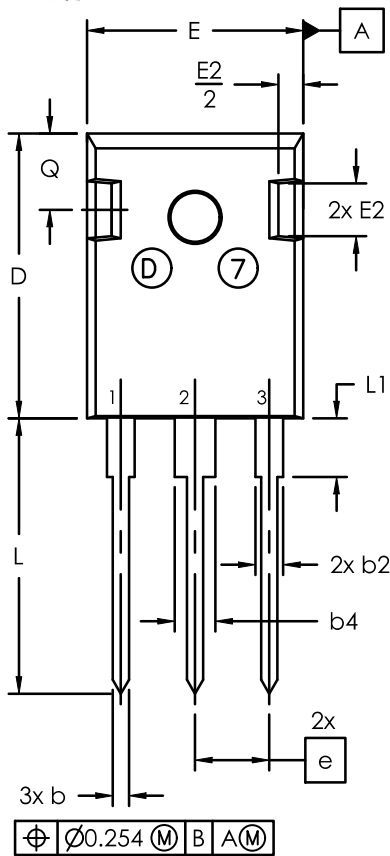

NOTE:

1. Dimensioning and tolerancing as per ASME Y14.5 - 2018
2. Controlling dimension : millimeters
3. Package Outline in compliance with JEDEC standard var. AD.
4. Dimensions D & E does not include mold flash.
5. ØP to have max draft angle of 1.7° to the top with max. hole diameter of 3.91mm.

SYM	millimeters		
	MIN	NOM	MAX
A	4.70	5.03	5.31
A1	2.21	2.40	2.59
A2	1.50	2.03	2.49
b	0.99	1.20	1.40
b2	1.65	2.03	2.39
b4	2.59	3.00	3.43
c	0.38	0.60	0.89
D	20.70	20.96	21.46
D1	13.08	—	—
D2	0.51	1.19	1.35
E	15.49	15.90	16.26
e	5.44 BSC		
E1	13.00	13.30	13.60
E2	3.43	3.89	5.20
L	19.62	20.27	20.32
L1	—	—	4.50
ØP	3.40	3.60	3.80
ØP1	7.06	7.19	7.39
Q	5.38	5.62	6.20
S	6.15 BSC		
θ	3°		
θ1	20°		
θ2	10°		

DOCUMENT NUMBER:	98AON88794E	Electronic versions are uncontrolled except when accessed directly from the Document Repository. Printed versions are uncontrolled except when stamped "CONTROLLED COPY" in red.
DESCRIPTION:	TO247-3 15.90x20.96x5.03, 5.44P	PAGE 1 OF 1

onsemi and ONSEMI are trademarks of Semiconductor Components Industries, LLC dba onsemi or its subsidiaries in the United States and/or other countries. onsemi reserves the right to make changes without further notice to any products herein. onsemi makes no warranty, representation or guarantee regarding the suitability of its products for any particular purpose, nor does onsemi assume any liability arising out of the application or use of any product or circuit, and specifically disclaims any and all liability, including without limitation special, consequential or incidental damages. onsemi does not convey any license under its patent rights nor the rights of others.

onsemi, **Onsemi**, and other names, marks, and brands are registered and/or common law trademarks of Semiconductor Components Industries, LLC dba "**onsemi**" or its affiliates and/or subsidiaries in the United States and/or other countries. **onsemi** owns the rights to a number of patents, trademarks, copyrights, trade secrets, and other intellectual property. A listing of **onsemi**'s product/patent coverage may be accessed at www.onsemi.com/site/pdf/Patent-Marking.pdf. **onsemi** reserves the right to make changes at any time to any products or information herein, without notice. The information herein is provided "as-is" and **onsemi** makes no warranty, representation or guarantee regarding the accuracy of the information, product features, availability, functionality, or suitability of its products for any particular purpose, nor does **onsemi** assume any liability arising out of the application or use of any product or circuit, and specifically disclaims any and all liability, including without limitation special, consequential or incidental damages. Buyer is responsible for its products and applications using **onsemi** products, including compliance with all laws, regulations and safety requirements or standards, regardless of any support or applications information provided by **onsemi**. "Typical" parameters which may be provided in **onsemi** data sheets and/or specifications can and do vary in different applications and actual performance may vary over time. All operating parameters, including "Typicals" must be validated for each customer application by customer's technical experts. **onsemi** does not convey any license under any of its intellectual property rights nor the rights of others. **onsemi** products are not designed, intended, or authorized for use as a critical component in life support systems or any FDA Class 3 medical devices or medical devices with a same or similar classification in a foreign jurisdiction or any devices intended for implantation in the human body. Should Buyer purchase or use **onsemi** products for any such unintended or unauthorized application, Buyer shall indemnify and hold **onsemi** and its officers, employees, subsidiaries, affiliates, and distributors harmless against all claims, costs, damages, and expenses, and reasonable attorney fees arising out of, directly or indirectly, any claim of personal injury or death associated with such unintended or unauthorized use, even if such claim alleges that **onsemi** was negligent regarding the design or manufacture of the part. **onsemi** is an Equal Opportunity/Affirmative Action Employer. This literature is subject to all applicable copyright laws and is not for resale in any manner.

ADDITIONAL INFORMATION

TECHNICAL PUBLICATIONS:

Technical Library: www.onsemi.com/design/resources/technical-documentation
onsemi Website: www.onsemi.com

ONLINE SUPPORT: www.onsemi.com/support

For additional information, please contact your local Sales Representative at www.onsemi.com/support/sales