

Plastic Infrared Light Emitting Diode

QEE113

Description

The QEE113 is a 940 nm GaAs LED encapsulated in a medium wide angle, plastic sidelooker package.

Features

- $\lambda = 940 \text{ nm}$
- Package Type = Sidelooker
- Chip Material = GaAs
- Matched Photosensor: QSE113
- Medium Wide Emission Angle, 50°
- Package Material: Clear Epoxy
- High Output Power
- Gray Dot Marking on the Top Side
- This is a Pb-Free Device

ABSOLUTE MAXIMUM RATINGS ($T_A = 25^\circ\text{C}$ unless otherwise noted)

| Symbol | Parameter | Value | Unit |
|-------------|--|--------------|------------------|
| T_{OPR} | Operating Temperature | -40 to +100 | $^\circ\text{C}$ |
| T_{STG} | Storage Temperature | -40 to +100 | $^\circ\text{C}$ |
| T_{SOL-I} | Soldering Temperature (Iron) (Note 2), (Note 3), (Note 4) | 240 for 5 s | $^\circ\text{C}$ |
| T_{SOL-F} | Soldering Temperature (Flow) (Note 2), (Note 3) | 260 for 10 s | $^\circ\text{C}$ |
| I_F | Continuous Forward Current | 50 | mA |
| V_R | Reverse Voltage | 5 | V |
| P_D | Power Dissipation (Note 1) | 100 | mW |

Stresses exceeding those listed in the Maximum Ratings table may damage the device. If any of these limits are exceeded, device functionality should not be assumed, damage may occur and reliability may be affected.

1. Derate power dissipation linearly 1.33 mW/ $^\circ\text{C}$ above 25°C .
2. RMA flux is recommended.
3. Methanol or Isopropyl alcohols are recommended as cleaning agents.
4. Soldering iron 1/16" (1.6 mm) minimum from housing.

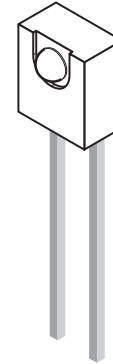

SIDELOOKER EMITTER
CASE 100CJ

SCHEMATIC

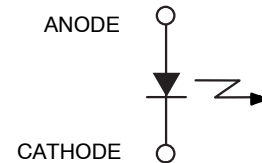

ORDERING INFORMATION

| Device | Package | Shipping† |
|------------|------------------------------------|-----------------------------|
| QEE113 | SIDELOOKER EMITTER (Pb-Free) | 500 units / Bulk Bag |
| QEE113E3R0 | SIDELOOKER EMITTER (Pb-Free) | 2000 units / Tape & Reel |

†For information on tape and reel specifications, including part orientation and tape sizes, please refer to our Tape and Reel Packaging Specification Brochure, [BRD8011/D](#).

QEE113

ELECTRICAL / OPTICAL CHARACTERISTICS (T_A = 25°C unless otherwise noted)

| Symbol | Parameter | Conditions | Min | Typ | Max | Unit |
|------------------------------------|--------------------------|---|-----|------|-----|-------|
| λ_{PE} | Peak Emission Wavelength | I _F = 20 mA | – | 945 | – | nm |
| TC _{λ} | Temperature Coefficient | | – | 0.3 | – | nm/°C |
| 2 $\theta^{1/2}$ | Emission Angle | I _F = 100 mA | – | 50 | – | ° |
| V _F | Forward Voltage | I _F = 100 mA, t _p = 20 ms | – | – | 1.5 | V |
| TC _{V_F} | Temperature Coefficient | | – | –2 | – | mV/°C |
| I _R | Reverse Current | V _R = 5 V | – | – | 10 | μA |
| I _E | Radiant Intensity | I _F = 100 mA, t _p = 20 ms | 3 | 7.5 | 12 | mW/sr |
| TC _{I_E} | Temperature Coefficient | | – | –0.7 | – | %/°C |
| t _r | Rise Time | I _F = 100 mA | – | 800 | – | ns |
| t _f | Fall Time | | – | 800 | – | ns |
| C _j | Junction Capacitance | V _R = 0 V | – | 14 | – | pF |

Product parametric performance is indicated in the Electrical Characteristics for the listed test conditions, unless otherwise noted. Product performance may not be indicated by the Electrical Characteristics if operated under different conditions.

TYPICAL PERFORMANCE CHARACTERISTICS

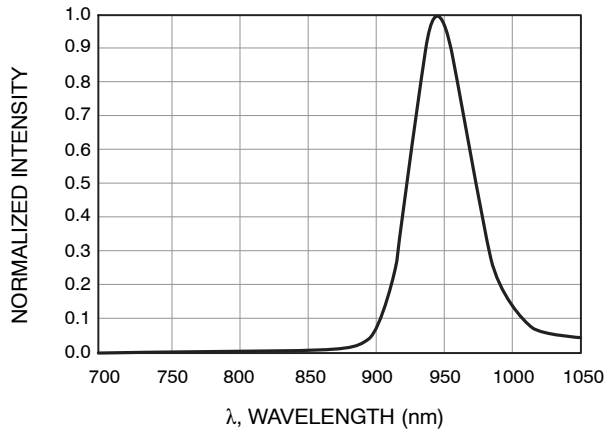

Figure 1. Normalized Intensity vs. Wavelength

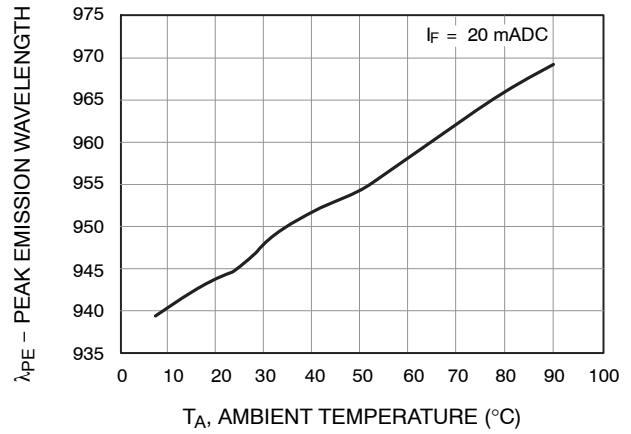

Figure 2. Peak Wavelength vs. Ambient Temperature

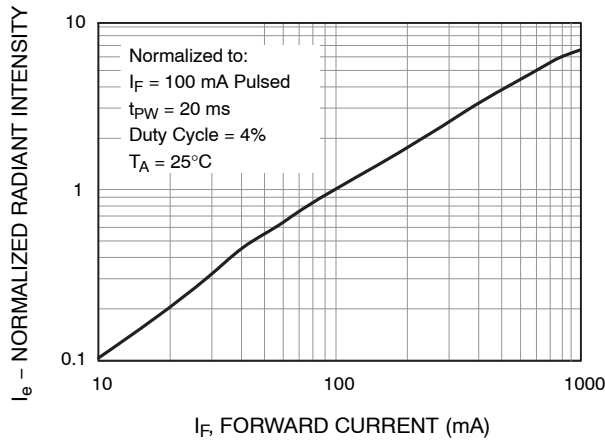

Figure 3. Normalized Radiant Intensity vs. Forward Current

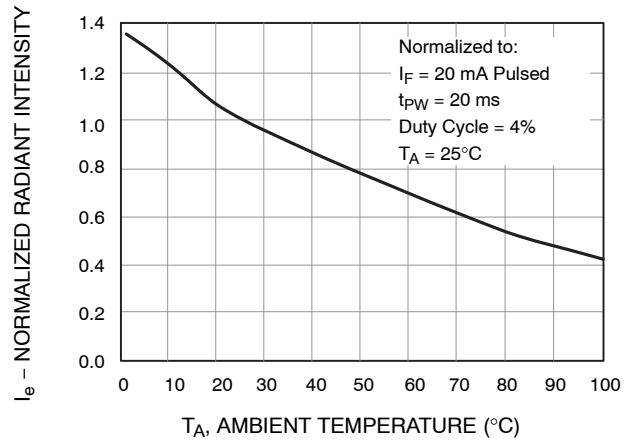

Figure 4. Normalized Radiant Intensity vs. Ambient Temperature

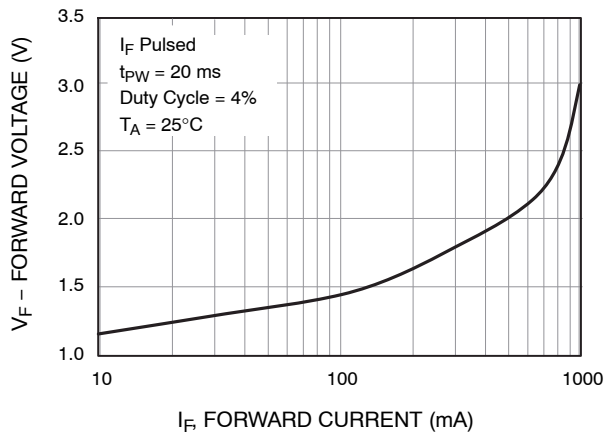

Figure 5. Forward Voltage vs. Forward Current

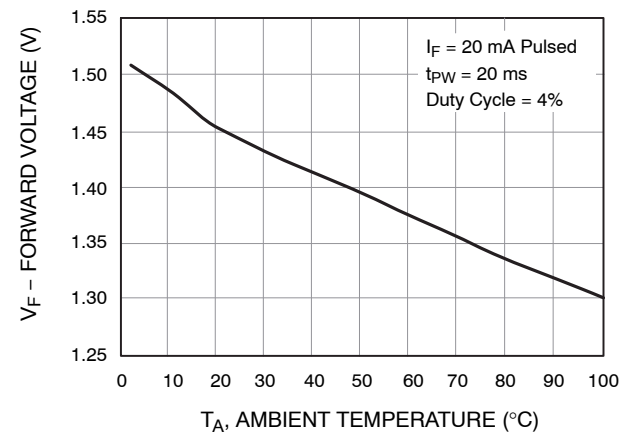

Figure 6. Forward Voltage vs. Ambient Temperature

QEE113

TYPICAL PERFORMANCE CHARACTERISTICS (continued)

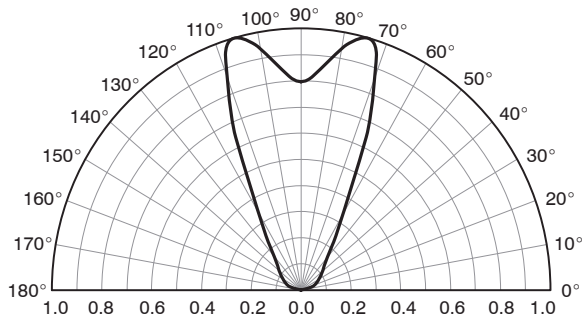

Figure 7. Radiation Diagram

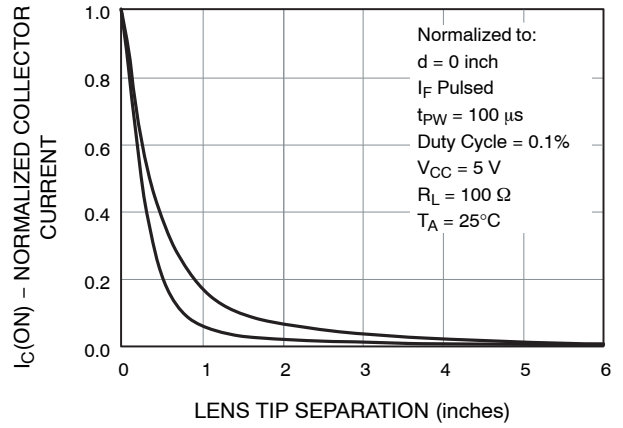
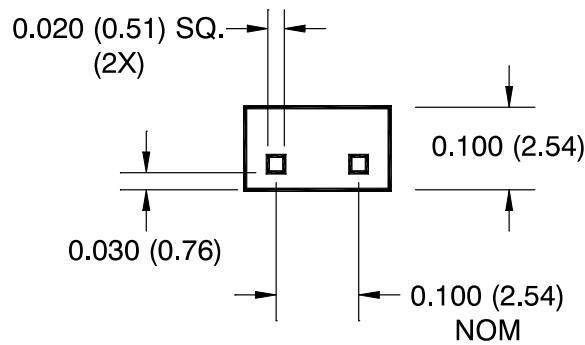
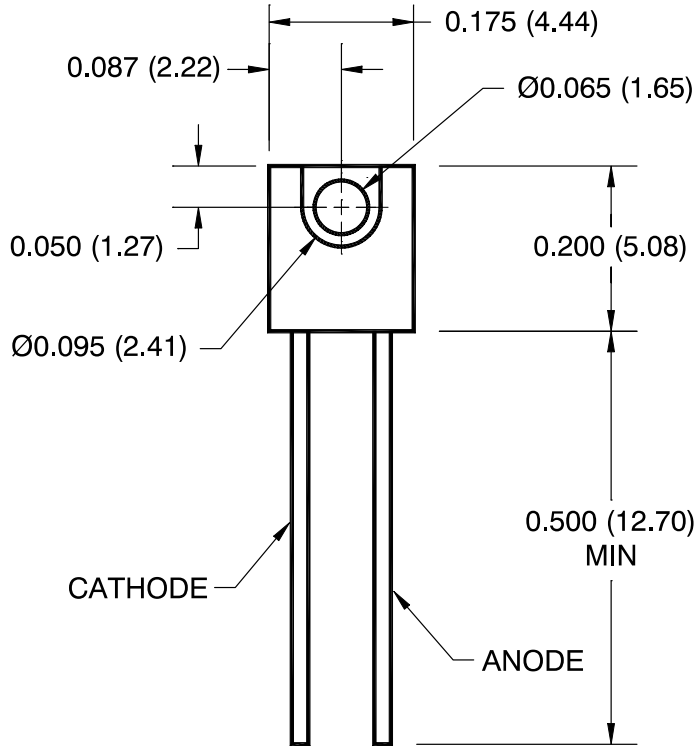

Figure 8. Coupling Characteristics of QEE113 and QSE113

SIDELOOKER EMITTER
CASE 100CJ
ISSUE O

DATE 30 NOV 2016



Notes:

1. Dimensions for all drawings are in inches (mm).
2. Tolerance of ± 0.010 (0.25) on all non-nominal dimensions unless otherwise specified.

| | | |
|-------------------------|---------------------------|---|
| DOCUMENT NUMBER: | 98AON13428G | Electronic versions are uncontrolled except when accessed directly from the Document Repository. Printed versions are uncontrolled except when stamped "CONTROLLED COPY" in red. |
| DESCRIPTION: | SIDELOOKER EMITTER | PAGE 1 OF 1 |

ON Semiconductor and  are trademarks of Semiconductor Components Industries, LLC dba ON Semiconductor or its subsidiaries in the United States and/or other countries. ON Semiconductor reserves the right to make changes without further notice to any products herein. ON Semiconductor makes no warranty, representation or guarantee regarding the suitability of its products for any particular purpose, nor does ON Semiconductor assume any liability arising out of the application or use of any product or circuit, and specifically disclaims any and all liability, including without limitation special, consequential or incidental damages. ON Semiconductor does not convey any license under its patent rights nor the rights of others.

onsemi, **Onsemi**, and other names, marks, and brands are registered and/or common law trademarks of Semiconductor Components Industries, LLC dba "**onsemi**" or its affiliates and/or subsidiaries in the United States and/or other countries. **onsemi** owns the rights to a number of patents, trademarks, copyrights, trade secrets, and other intellectual property. A listing of **onsemi**'s product/patent coverage may be accessed at www.onsemi.com/site/pdf/Patent-Marking.pdf. **onsemi** reserves the right to make changes at any time to any products or information herein, without notice. The information herein is provided "as-is" and **onsemi** makes no warranty, representation or guarantee regarding the accuracy of the information, product features, availability, functionality, or suitability of its products for any particular purpose, nor does **onsemi** assume any liability arising out of the application or use of any product or circuit, and specifically disclaims any and all liability, including without limitation special, consequential or incidental damages. Buyer is responsible for its products and applications using **onsemi** products, including compliance with all laws, regulations and safety requirements or standards, regardless of any support or applications information provided by **onsemi**. "Typical" parameters which may be provided in **onsemi** data sheets and/or specifications can and do vary in different applications and actual performance may vary over time. All operating parameters, including "Typicals" must be validated for each customer application by customer's technical experts. **onsemi** does not convey any license under any of its intellectual property rights nor the rights of others. **onsemi** products are not designed, intended, or authorized for use as a critical component in life support systems or any FDA Class 3 medical devices or medical devices with a same or similar classification in a foreign jurisdiction or any devices intended for implantation in the human body. Should Buyer purchase or use **onsemi** products for any such unintended or unauthorized application, Buyer shall indemnify and hold **onsemi** and its officers, employees, subsidiaries, affiliates, and distributors harmless against all claims, costs, damages, and expenses, and reasonable attorney fees arising out of, directly or indirectly, any claim of personal injury or death associated with such unintended or unauthorized use, even if such claim alleges that **onsemi** was negligent regarding the design or manufacture of the part. **onsemi** is an Equal Opportunity/Affirmative Action Employer. This literature is subject to all applicable copyright laws and is not for resale in any manner.

ADDITIONAL INFORMATION

TECHNICAL PUBLICATIONS:

Technical Library: www.onsemi.com/design/resources/technical-documentation
onsemi Website: www.onsemi.com

ONLINE SUPPORT: www.onsemi.com/support

For additional information, please contact your local Sales Representative at www.onsemi.com/support/sales

