



ON Semiconductor®

# QED223 Plastic Infrared Light Emitting Diode

## Features

- $\lambda = 880\text{nm}$
- Chip material = AlGaAs
- Package type: T-1 3/4 (5mm lens diameter)
- Matched photosensor: QSD123/QSD124
- Medium wide emission angle,  $30^\circ$
- High output power
- Package material and color: clear, purple tinted, plastic

## Description

The QED223 is 880nm AlGaAs LEDs encapsulated in a clear purple tinted, plastic T-1 3/4 package.

## Package Dimensions

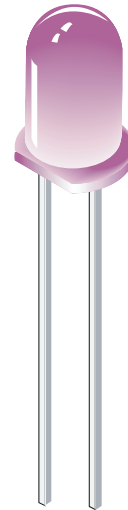
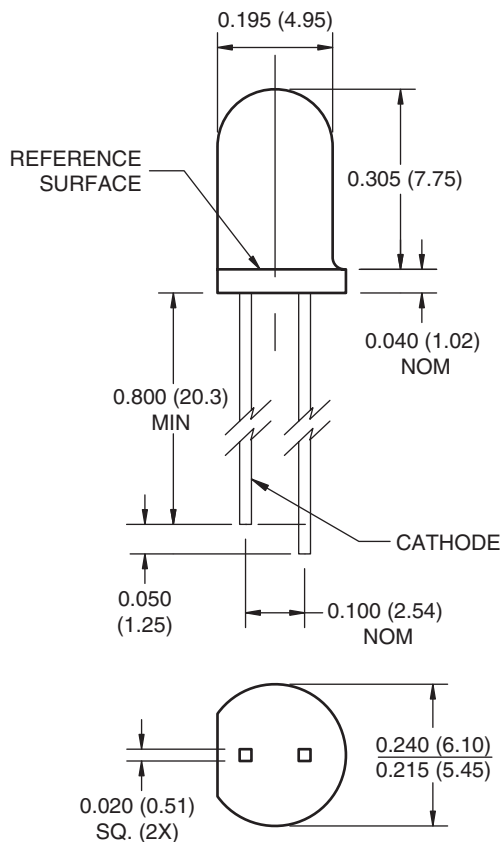

## Schematic

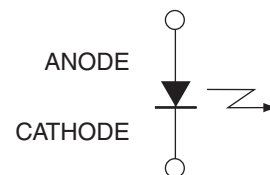

## Notes:

1. Dimensions of all drawings are in inches (mm).
2. Tolerance is  $\pm 0.010$  (0.25) on all non-nominal dimensions unless otherwise specified.

### Absolute Maximum Ratings ( $T_A = 25^\circ\text{C}$ unless otherwise specified)

Stresses exceeding the absolute maximum ratings may damage the device. The device may not function or be operable above the recommended operating conditions and stressing the parts to these levels is not recommended. In addition, extended exposure to stresses above the recommended operating conditions may affect device reliability. The absolute maximum ratings are stress ratings only.

Symbol	Parameter	Rating	Units
$T_{OPR}$	Operating Temperature	-40 to +100	$^\circ\text{C}$
$T_{STG}$	Storage Temperature	-40 to +100	$^\circ\text{C}$
$T_{SOL-I}$	Soldering Temperature (Iron) <sup>(2)(3)(4)</sup>	240 for 5 sec	$^\circ\text{C}$
$T_{SOL-F}$	Soldering Temperature (Flow) <sup>(2)(3)</sup>	260 for 10 sec	$^\circ\text{C}$
$I_F$	Continuous Forward Current	100	mA
$V_R$	Reverse Voltage	5	V
$P_D$	Power Dissipation <sup>(1)</sup>	200	mW
$I_{F(Peak)}$	Peak Forward Current <sup>(5)</sup>	1.5	A

**Notes:**

- Derate power dissipation linearly 2.67mW/ $^\circ\text{C}$  above 25 $^\circ\text{C}$ .
- RMA flux is recommended.
- Methanol or isopropyl alcohols are recommended as cleaning agents.
- Soldering iron 1/16" (1.6mm) minimum from housing.
- Pulse conditions;  $t_p = 100\mu\text{s}$ ,  $T = 10\text{ms}$ .

### Electrical / Optical Characteristics ( $T_A = 25^\circ\text{C}$ )

Symbol	Parameter	Test Conditions	Min.	Typ.	Max.	Units
$\lambda_{PE}$	Peak Emission Wavelength	$I_F = 20\text{mA}$		890		nm
$TC_\lambda$	Temperature Coefficient			0.2		nm/ $^\circ\text{C}$
$2\theta^{1/2}$	Emission Angle	$I_F = 100\text{mA}$		30		$^\circ$
$V_F$	Forward Voltage	$I_F = 100\text{mA}$ , $t_p = 20\text{ms}$			1.7	V
$TC_{VF}$	Temperature Coefficient			-6		mV/ $^\circ\text{C}$
$I_R$	Reverse Current	$V_R = 5\text{V}$			10	$\mu\text{A}$
$I_E$	Radiant Intensity	$I_F = 100\text{mA}$ , $t_p = 20\text{ms}$	25			mW/sr
$TC_{IE}$	Temperature Coefficient			-0.3		%/ $^\circ\text{C}$
$t_r$	Rise Time	$I_F = 100\text{mA}$		900		ns
$t_f$	Fall Time			800		ns
$C_j$	Junction Capacitance	$V_R = 0\text{V}$		11		pF

## Typical Performance Curves

Figure 1. Normalized Intensity vs. Wavelength

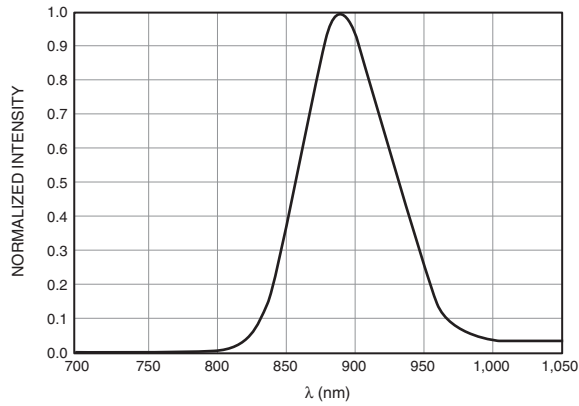

Figure 2. Peak Wavelength vs. Ambient Temperature

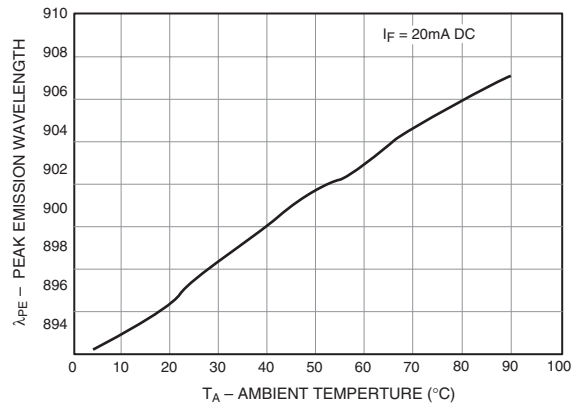

Figure 3. Normalized Radiant Intensity vs. Forward Current

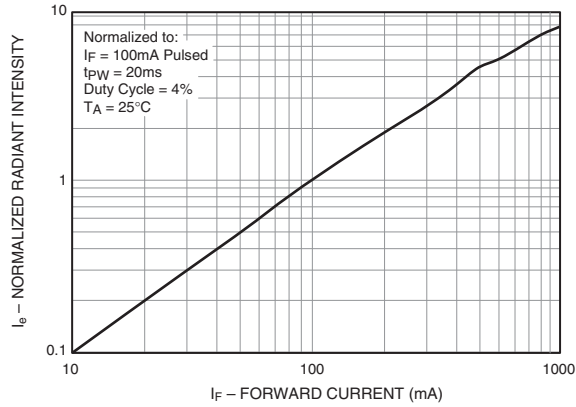

Figure 4. Normalized Radiant Intensity vs. Ambient Temperature

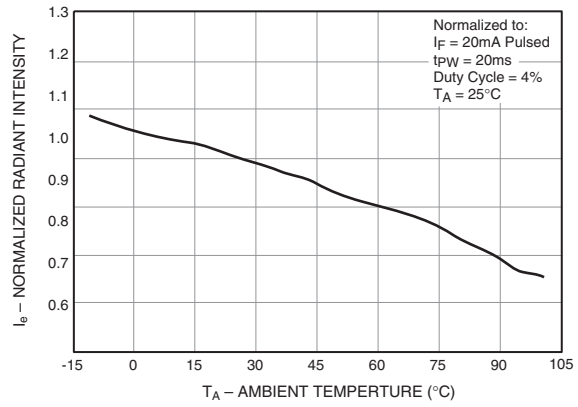

Figure 5. Forward Voltage vs. Forward Current

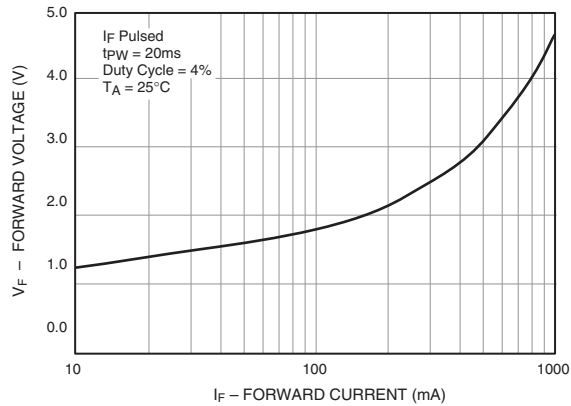
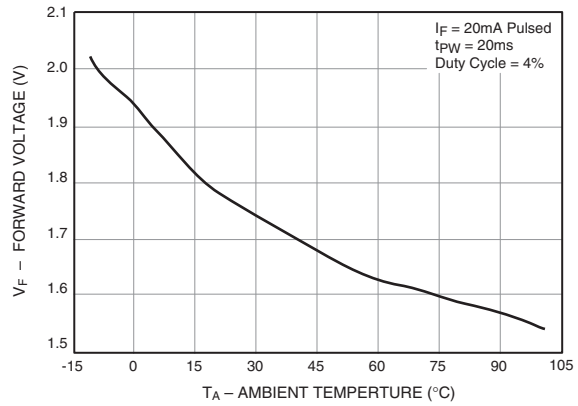
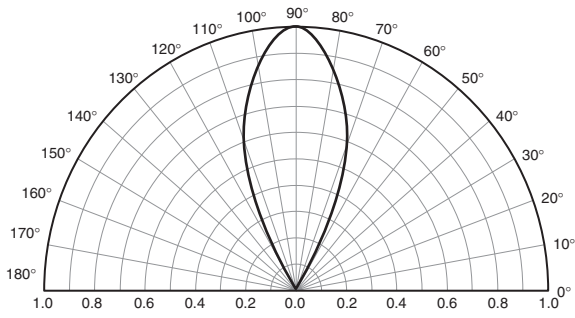

Figure 6. Forward Voltage vs. Ambient Temperature



**Typical Performance Curves (Continued)**

**Figure 7. Radiation Diagram**



**Figure 8. Coupling Characteristics of QED22X and QSD22X**

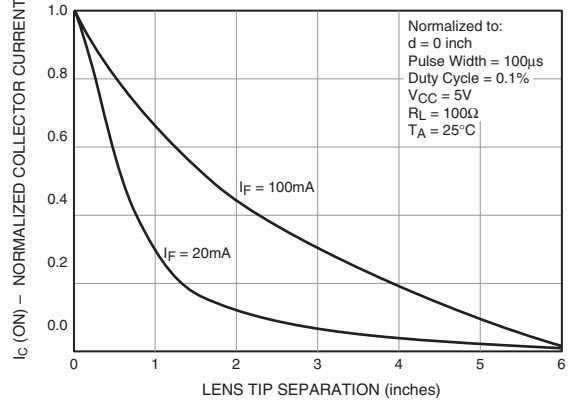

ON Semiconductor and  are trademarks of Semiconductor Components Industries, LLC dba ON Semiconductor or its subsidiaries in the United States and/or other countries. ON Semiconductor owns the rights to a number of patents, trademarks, copyrights, trade secrets, and other intellectual property. A listing of ON Semiconductor's product/patent coverage may be accessed at [www.onsemi.com/site/pdf/Patent-Marking.pdf](http://www.onsemi.com/site/pdf/Patent-Marking.pdf). ON Semiconductor reserves the right to make changes without further notice to any products herein. ON Semiconductor makes no warranty, representation or guarantee regarding the suitability of its products for any particular purpose, nor does ON Semiconductor assume any liability arising out of the application or use of any product or circuit, and specifically disclaims any and all liability, including without limitation special, consequential or incidental damages. Buyer is responsible for its products and applications using ON Semiconductor products, including compliance with all laws, regulations and safety requirements or standards, regardless of any support or applications information provided by ON Semiconductor. "Typical" parameters which may be provided in ON Semiconductor data sheets and/or specifications can and do vary in different applications and actual performance may vary over time. All operating parameters, including "Typicals" must be validated for each customer application by customer's technical experts. ON Semiconductor does not convey any license under its patent rights nor the rights of others. ON Semiconductor products are not designed, intended, or authorized for use as a critical component in life support systems or any FDA Class 3 medical devices or medical devices with a same or similar classification in a foreign jurisdiction or any devices intended for implantation in the human body. Should Buyer purchase or use ON Semiconductor products for any such unintended or unauthorized application, Buyer shall indemnify and hold ON Semiconductor and its officers, employees, subsidiaries, affiliates, and distributors harmless against all claims, costs, damages, and expenses, and reasonable attorney fees arising out of, directly or indirectly, any claim of personal injury or death associated with such unintended or unauthorized use, even if such claim alleges that ON Semiconductor was negligent regarding the design or manufacture of the part. ON Semiconductor is an Equal Opportunity/Affirmative Action Employer. This literature is subject to all applicable copyright laws and is not for resale in any manner.

## PUBLICATION ORDERING INFORMATION

### LITERATURE FULFILLMENT:

Literature Distribution Center for ON Semiconductor  
19521 E. 32nd Pkwy, Aurora, Colorado 80011 USA  
**Phone:** 303-675-2175 or 800-344-3860 Toll Free USA/Canada  
**Fax:** 303-675-2176 or 800-344-3867 Toll Free USA/Canada  
**Email:** [orderlit@onsemi.com](mailto:orderlit@onsemi.com)

**N. American Technical Support:** 800-282-9855 Toll Free  
USA/Canada  
**Europe, Middle East and Africa Technical Support:**  
Phone: 421 33 790 2910  
**Japan Customer Focus Center**  
Phone: 81-3-5817-1050

**ON Semiconductor Website:** [www.onsemi.com](http://www.onsemi.com)  
**Order Literature:** <http://www.onsemi.com/orderlit>  
For additional information, please contact your local  
Sales Representative