

# NXH160T120L2Q1PG, NXH160T120L2Q1SG

## Q1PACK Module

This high-density, integrated power module combines high-performance IGBTs with rugged anti-parallel diodes.

### Features

- Extremely Efficient Trench with Fieldstop Technology
- Low Switching Loss Reduces System Power Dissipation
- Module Design Offers High Power Density
- Low Inductive Layout
- Q1PACK Package with Press-Fit and Solder Pins

### Typical Applications

- Solar Inverters
- Uninterruptable Power Supplies

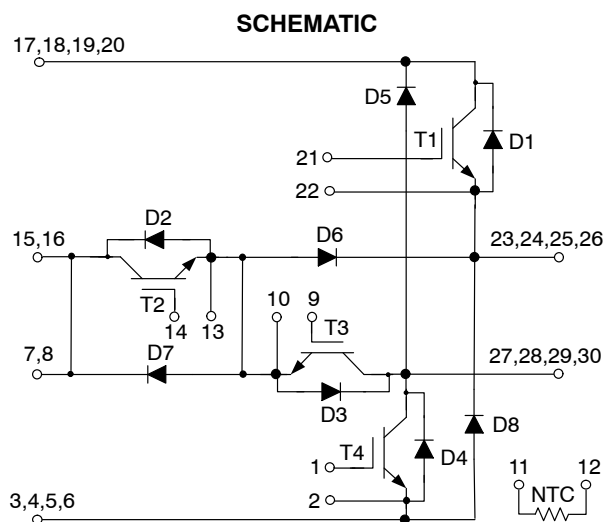

**ON Semiconductor®**

[www.onsemi.com](http://www.onsemi.com)

### PACKAGE PICTURE

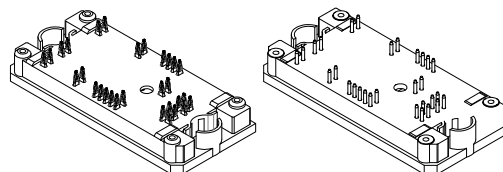

**Q1PACK  
CASE 180AD  
PRESS FIT**

**Q1PACK  
CASE 180AQ  
SOLDER PINS**

### DEVICE MARKING

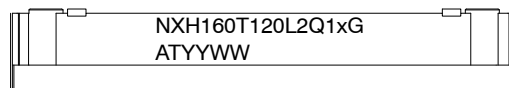

x = P or S  
G = Pb-Free Package  
AT = Assembly & Test Site Code  
YYWW = Year and Work Week Code

### PIN ASSIGNMENTS

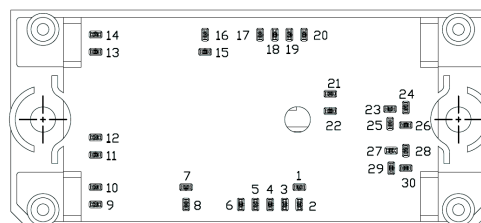

### ORDERING INFORMATION

See detailed ordering and shipping information on page 14 of this data sheet.

# NXH160T120L2Q1PG, NXH160T120L2Q1SG

**Table 1. ABSOLUTE MAXIMUM RATINGS**

Rating	Symbol	Value	Unit
<b>HALFBRIDGE IGBT INVERSE DIODE (D1, D4)</b>			
Peak Repetitive Reverse Voltage	$V_{RRM}$	1200	V
Forward Current, DC @ $T_h = 80^\circ\text{C}$	$I_F$	20	A
Repetitive Peak Forward Current $T_{\text{pulse}}$ limited by $T_{J\text{max}}$	$I_{FRM}$	80	A
Power Dissipation per Diode $T_j = T_{J\text{max}}$ $T_h = 80^\circ\text{C}$	$P_{\text{tot}}$	51	W
Maximum Junction Temperature	$T_J$	150	$^\circ\text{C}$
<b>HALFBRIDGE IGBT (T1, T4)</b>			
Collector-emitter voltage	$V_{CES}$	1200	V
Collector current @ $T_h = 80^\circ\text{C}$	$I_C$	140	A
Pulsed Collector Current, $T_{\text{pulse}}$ Limited by $T_{J\text{max}}$	$I_{CM}$	480	A
Power Dissipation per IGBT $T_j = T_{J\text{max}}$ $T_h = 80^\circ\text{C}$	$P_{\text{tot}}$	280	W
Gate-emitter voltage	$V_{GE}$	$\pm 20$	V
Short Circuit Withstand Time $V_{GE} = 15\text{ V}$ , $V_{CE} = 600\text{ V}$ , $T_J \leq 150^\circ\text{C}$	$T_{SC}$	10	$\mu\text{s}$
Maximum Junction Temperature	$T_J$	150	$^\circ\text{C}$
<b>NP DIODE (D6, D7)</b>			
Peak Repetitive Reverse Voltage	$V_{RRM}$	650	V
Forward Current, DC @ $T_h = 80^\circ\text{C}$	$I_F$	58	A
Repetitive Peak Forward Current, $T_{\text{pulse}}$ limited by $T_{J\text{max}}$	$I_{FRM}$	200	A
Power Dissipation Per Diode $T_j = T_{J\text{max}}$ $T_h = 80^\circ\text{C}$	$P_{\text{tot}}$	89	W
Maximum Junction Temperature	$T_J$	150	$^\circ\text{C}$
<b>NP IGBT (T2, T3)</b>			
Collector-emitter voltage	$V_{CES}$	650	V
Collector current @ $T_h = 80^\circ\text{C}$	$I_C$	83	A
Pulsed collector current, $T_{\text{pulse}}$ limited by $T_{J\text{max}}$	$I_{CM}$	235	A
Power Dissipation Per IGBT $T_j = T_{J\text{max}}$ $T_h = 80^\circ\text{C}$	$P_{\text{tot}}$	117	W
Gate-emitter voltage	$V_{GE}$	$\pm 20$	V
Short Circuit Withstand Time $V_{GE} = 15\text{ V}$ , $V_{CE} = 400\text{ V}$ , $T_J \leq 150^\circ\text{C}$	$T_{sc}$	5	$\mu\text{s}$
Maximum Junction Temperature	$T_J$	150	$^\circ\text{C}$
<b>NP INVERSE DIODE (D2, D3)</b>			
Peak Repetitive Reverse Voltage	$V_{RRM}$	650	V
Forward Current, DC @ $T_h = 80^\circ\text{C}$	$I_F$	17	A
Repetitive Peak Forward Current, $T_{\text{pulse}}$ limited by $T_{J\text{max}}$	$I_{FRM}$	68	A
Power Dissipation Per Diode $T_j = T_{J\text{max}}$ $T_h = 80^\circ\text{C}$	$P_{\text{tot}}$	28	W
Maximum Junction Temperature	$T_J$	150	$^\circ\text{C}$
<b>HALFBRIDGE DIODE (D5, D8)</b>			
Peak Repetitive Reverse Voltage	$V_{RRM}$	1200	V
Forward Current, DC @ $T_h = 80^\circ\text{C}$ (per diode)	$I_F$	45	A
Repetitive Peak Forward Current, $T_{\text{pulse}}$ limited by $T_{J\text{max}}$	$I_{FRM}$	180	A
Power Dissipation Per Diode $T_j = T_{J\text{max}}$ $T_h = 80^\circ\text{C}$	$P_{\text{tot}}$	78	W

# NXH160T120L2Q1PG, NXH160T120L2Q1SG

**Table 1. ABSOLUTE MAXIMUM RATINGS**

Rating	Symbol	Value	Unit
<b>HALFBRIDGE DIODE (D5, D8)</b>			
Junction Temperature	$T_J$	150	°C
<b>THERMAL PROPERTIES</b>			
Operating Temperature under switching condition	$T_{VJ\ OP}$	-40 to ( $T_{jmax}-25$ )	°C
Storage Temperature range	$T_{stg}$	-40 to 125	°C
<b>INSULATION PROPERTIES</b>			
Isolation test voltage, t = 1 sec, 60 Hz/50 Hz	$V_{is}$	3000	$V_{RMS}$
Creepage distance		12.7	mm
Clearance		8.06	mm

Stresses exceeding those listed in the Maximum Ratings table may damage the device. If any of these limits are exceeded, device functionality should not be assumed, damage may occur and reliability may be affected.

**Table 2. ELECTRICAL CHARACTERISTICS** ( $T_J = 25^\circ\text{C}$  unless otherwise specified)

Parameter	Test Conditions	Symbol	Min	Typ	Max	Unit
<b>HALFBRIDGE IGBT INVERSE DIODE (D1, D4) CHARACTERISTICS</b>						
Forward voltage	$I_F = 7\text{ A}, T_j = 25^\circ\text{C}$ $I_F = 7\text{ A}, T_j = 125^\circ\text{C}$	$V_F$	-	1.46 1.49	2.7 -	V
Thermal Resistance – chip-to-heatsink	Thermal grease, Thickness = 2 Mil $\pm$ 2%, $\lambda = 1\text{ W/mK}$	$R_{thJH}$		1.864		°C/W
<b>HALFBRIDGE IGBT (T1, T4) CHARACTERISTICS</b>						
Collector-emitter saturation voltage	$V_{GE} = 15\text{ V}, I_C = 160\text{ A}, T_j = 25^\circ\text{C}$ $V_{GE} = 15\text{ V}, I_C = 160\text{ A}, T_j = 125^\circ\text{C}$	$V_{CE(sat)}$	-	2.06 2.10	2.50 -	V
Gate-emitter threshold voltage	$V_{GE} = V_{CE}, I_C = 6\text{ mA}$	$V_{GE(TH)}$	5.0	5.80	6.50	V
Collector-emitter cutoff current	$V_{GE} = 0\text{ V}, V_{CE} = 1200\text{ V}$	$I_{CES}$	-	-	800	$\mu\text{A}$
Gate leakage current	$V_{GE} = 20\text{ V}, V_{CE} = 0\text{ V}$	$I_{GES}$	-	-	800	nA
Turn-on delay time	$T_j = 125^\circ\text{C}$ $V_{CE} = 350\text{ V}, I_C = 100\text{ A}$ $V_{GE} = \pm 15\text{ V}, R_G = 4\ \Omega$	$t_{d(on)}$	-	55	-	ns
Rise time		$t_r$	-	50	-	
Turn-off delay time		$t_{d(off)}$	-	430	-	
Fall time		$t_f$	-	105	-	
Turn on switching loss		$E_{on}$	-	2.73	-	
Turn off switching loss	$E_{off}$	-	3.58	-		
Input capacitance	$V_{CE} = 25\text{ V}, V_{GE} = 0\text{ V}, f = 10\text{ kHz}$	$C_{ies}$	-	38164	-	pF
Output capacitance		$C_{oes}$	-	644	-	
Reverse transfer capacitance		$C_{res}$	-	784	-	
Gate charge total	$V_{CE} = 600\text{ V}, I_C = 160\text{ A}, V_{GE} = 15\text{ V}$	$Q_g$	-	1664	-	nC
Thermal Resistance – chip-to-heatsink	Thermal grease, Thickness = 2 Mil $\pm$ 2%, $\lambda = 1\text{ W/mK}$	$R_{thJH}$		0.337		°C/W
<b>NP DIODE (D6, D7) CHARACTERISTICS</b>						
Forward voltage	$V_{GE} = 0\text{ V}, I_F = 150\text{ A}, T_j = 25^\circ\text{C}$ $V_{GE} = 0\text{ V}, I_F = 150\text{ A}, T_j = 125^\circ\text{C}$	$V_F$	-	2.15 2.36	2.60 -	V
Reverse leakage current	$V_{CE} = 650\text{ V}, V_{GE} = 0\text{ V}$	$I_r$	-	-	200	$\mu\text{A}$
Reverse recovery time	$T_j = 125^\circ\text{C}$ $V_{CE} = 350\text{ V}, I_C = 100\text{ A}$ $V_{GE} = \pm 15\text{ V}, R_G = 4\ \Omega$	$t_{rr}$	-	225	-	ns
Reverse recovery charge		$Q_{rr}$	-	6.15	-	$\mu\text{C}$
Peak reverse recovery current		$I_{rrm}$	-	85	-	A
Peak rate of fall of recovery current		$di/dt_{max}$	-	1315	-	A/ $\mu\text{s}$
Reverse recovery energy		$E_{rr}$	-	1.336	-	mJ
Thermal Resistance – chip-to-heatsink	Thermal grease, Thickness = 2 Mil $\pm$ 2%, $\lambda = 1\text{ W/mK}$	$R_{thJH}$	-	1.07	-	°C/W

# NXH160T120L2Q1PG, NXH160T120L2Q1SG

**Table 2. ELECTRICAL CHARACTERISTICS** ( $T_J = 25^\circ\text{C}$  unless otherwise specified)

Parameter	Test Conditions	Symbol	Min	Typ	Max	Unit
<b>NP IGBT (T2, T3)</b>						
Collector-emitter saturation voltage	$V_{CE} = 15\text{ V}, I_C = 150\text{ A}, T_J = 25^\circ\text{C}$ $V_{CE} = 15\text{ V}, I_C = 150\text{ A}, T_J = 125^\circ\text{C}$	$V_{CE(sat)}$	– –	1.65 1.84	2.0 –	V
Gate-emitter threshold voltage	$V_{GE} = V_{CE}, I_C = 8\text{ mA}$	$V_{GE(TH)}$	5.0	6.10	6.90	V
Collector-emitter cutoff current	$V_{GE} = 0\text{ V}, V_{CE} = 650\text{ V}$	$I_{CES}$	–	–	400	$\mu\text{A}$
Gate leakage current	$V_{GE} = 20\text{ V}, V_{CE} = 0\text{ V}$	$I_{GES}$	–	–	800	nA
Turn-on delay time	$T_J = 125^\circ\text{C}$ $V_{CE} = 350\text{ V}, I_C = 100\text{ A}$ $V_{GE} = \pm 15\text{ V}, R_G = 4\ \Omega$	$t_{d(on)}$	–	46	–	ns
Rise time		$t_r$	–	48	–	
Turn-off delay time		$t_{d(off)}$	–	250	–	
Fall time		$t_f$	–	105	–	
Turn on switching loss			$E_{on}$	–	1.245	–
Turn off switching loss		$E_{off}$	–	2.525	–	
Input capacitance	$V_{CE} = 25\text{ V}, V_{GE} = 0\text{ V}, f = 10\text{ kHz}$	$C_{ies}$	–	19380	–	pF
Output capacitance		$C_{oes}$	–	570	–	
Reverse transfer capacitance		$C_{res}$	–	496	–	
Gate charge total	$V_{CE} = 480\text{ V}, I_C = 150\text{ A}, V_{GE} = 15\text{ V}$	$Q_g$	–	790	–	nC
Thermal Resistance – chip-to-heatsink	Thermal grease, Thickness = 2 Mil $\pm$ 2%, $\lambda = 1\text{ W/mK}$	$R_{thJH}$	–	0.81	–	$^\circ\text{C/W}$
<b>NP INVERSE DIODE (D2, D3)</b>						
Forward voltage	$V_{GE} = 0\text{ V}, I_F = 15\text{ A}, T_J = 25^\circ\text{C}$ $V_{GE} = 0\text{ V}, I_F = 15\text{ A}, T_J = 125^\circ\text{C}$	$V_F$	– –	1.60 1.59	2.20 –	V
Thermal Resistance – chip-to-heatsink	Thermal grease, Thickness = 2 Mil $\pm$ 2%, $\lambda = 1\text{ W/mK}$	$R_{thJH}$		3.43		$^\circ\text{C/W}$
<b>HALFBRIDGE DIODE (D5, D8)</b>						
Forward voltage	$V_{GE} = 0\text{ V}, I_F = 150\text{ A}, T_J = 25^\circ\text{C}$ $V_{GE} = 0\text{ V}, I_F = 150\text{ A}, T_J = 125^\circ\text{C}$	$V_F$	– –	2.50 2.80	3.50 –	V
Reverse leakage current	$V_{CE} = 1200\text{ V}, V_{GE} = 0\text{ V}$	$I_r$	–	–	200	$\mu\text{A}$
Reverse recovery time	$T_J = 125^\circ\text{C}$ $V_{CE} = 350\text{ V}, I_C = 100\text{ A}$ $V_{GE} = \pm 15\text{ V}, R_G = 4\ \Omega$	$t_{rr}$	–	405	–	ns
Reverse recovery charge		$Q_{rr}$	–	15.5	–	$\mu\text{C}$
Peak reverse recovery current		$I_{rrm}$	–	220	–	A
Peak rate of fall of recovery current		$di/dt_{max}$	–	5440	–	$\text{A}/\mu\text{s}$
Reverse recovery energy		$E_{rr}$	–	5.225	–	mJ
Thermal Resistance – chip-to-heatsink	Thermal grease, Thickness = 2 Mil $\pm$ 2%, $\lambda = 1\text{ W/mK}$	$R_{thJH}$	–	1.213	–	$^\circ\text{C/W}$
<b>THERMISTOR CHARACTERISTICS</b>						
Nominal resistance		$R_{25}$	–	22	–	$\text{k}\Omega$
Nominal resistance	$T = 100^\circ\text{C}$	$R_{100}$	–	1486	–	$\Omega$
Deviation of R25		DR/R	–5	–	5	%
Power dissipation		$P_D$	–	200	–	mW
Power dissipation constant			–	2	–	$\text{mW/K}$
B-value	B(25/50), tol $\pm$ 3%		–	3950	–	K
B-value	B(25/100), tol $\pm$ 3%		–	3998	–	K

# NXH160T120L2Q1PG, NXH160T120L2Q1SG

## TYPICAL CHARACTERISTICS – HALF BRIDGE IGBT AND NEUTRAL POINT FORWARD DIODE

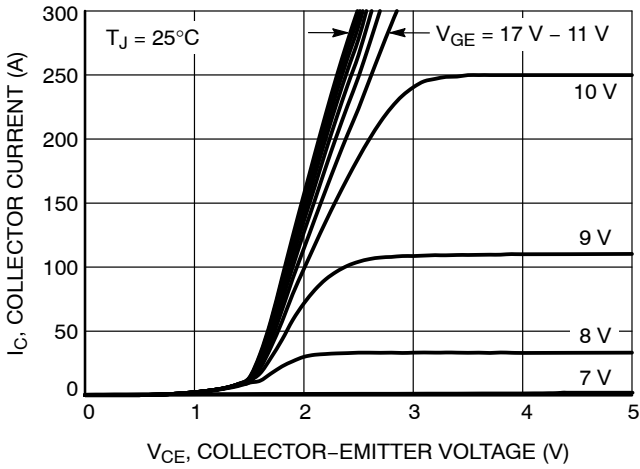

Figure 1. Typical Output Characteristics

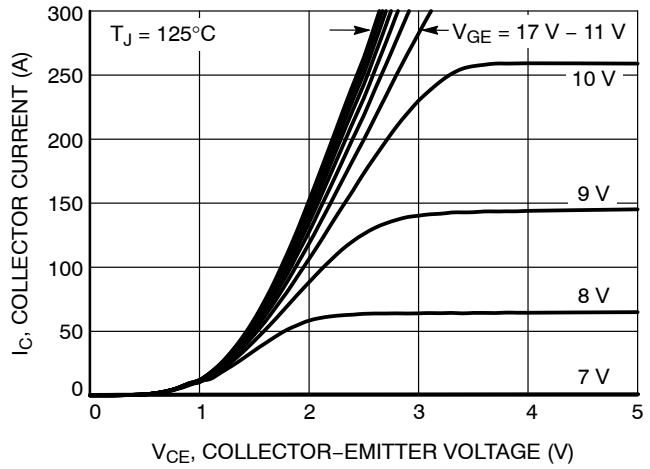

Figure 2. Typical Output Characteristics

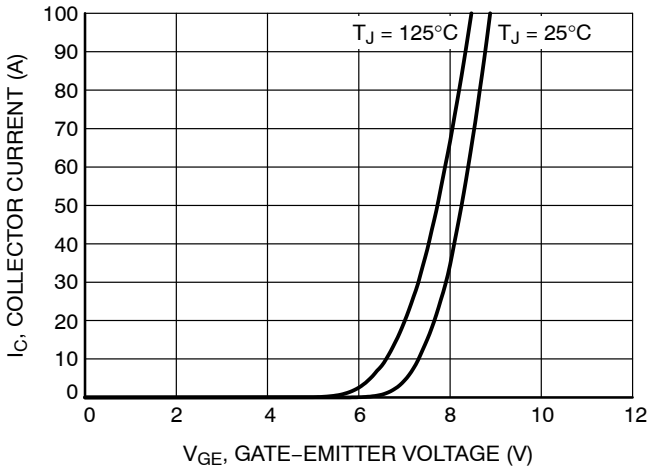

Figure 3. Typical Transfer Characteristics

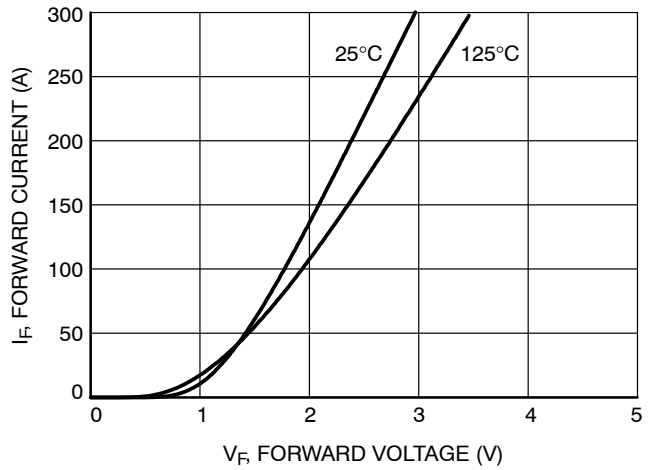

Figure 4. Diode Forward Characteristics

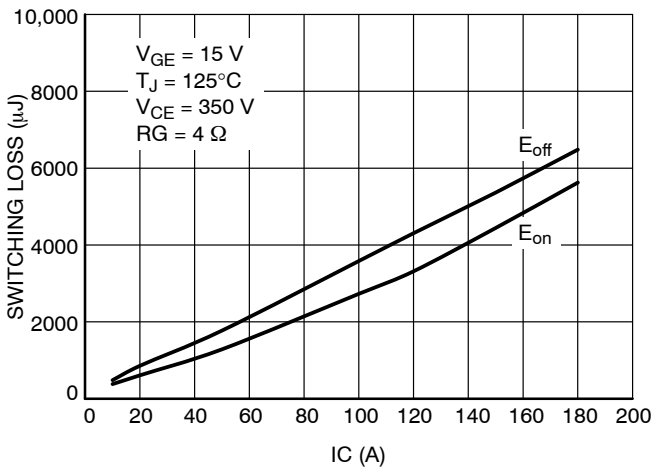

Figure 5. Typical Switching Loss vs.  $I_C$

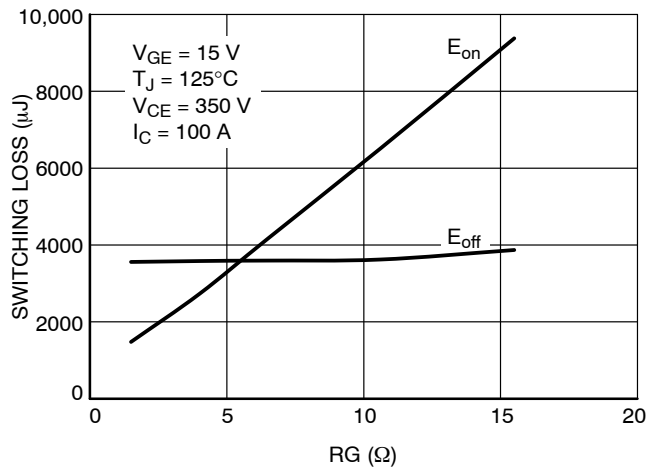
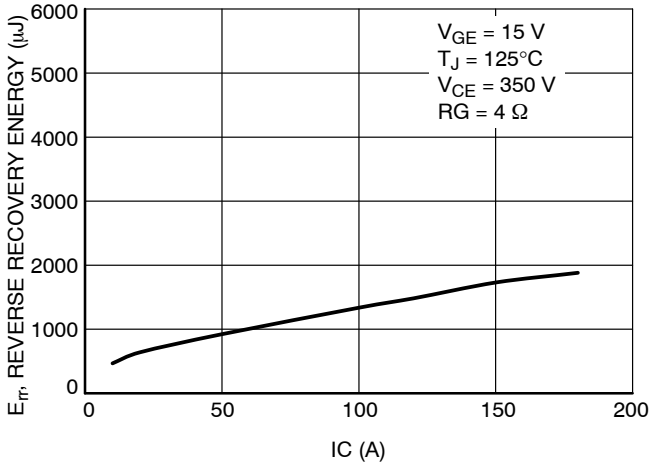

Figure 6. Typical Switching Loss vs.  $R_G$

# NXH160T120L2Q1PG, NXH160T120L2Q1SG

## TYPICAL CHARACTERISTICS – HALF BRIDGE IGBT AND NEUTRAL POINT FORWARD DIODE



**Figure 7. Typical Reverse Recovery Energy Loss vs. IC**

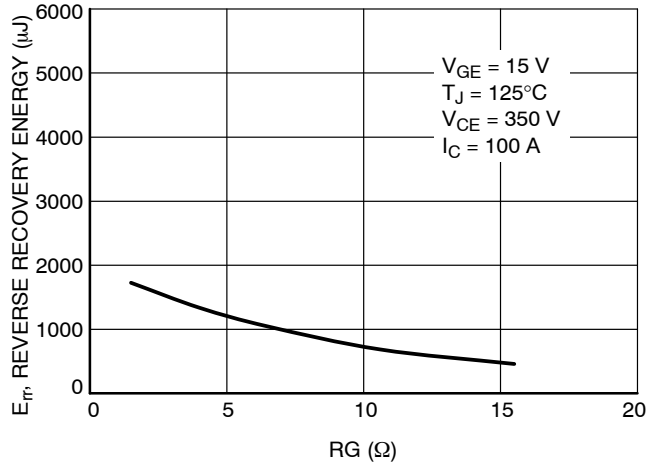

**Figure 8. Typical Reverse Recovery Energy Loss vs. R<sub>G</sub>**

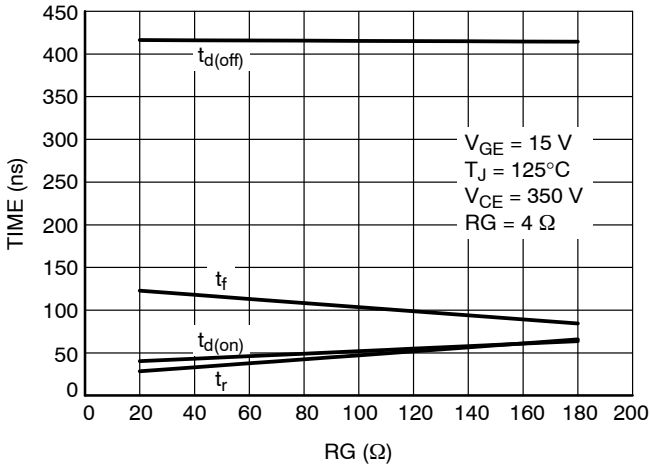

**Figure 9. Typical Switching Time vs. IC**

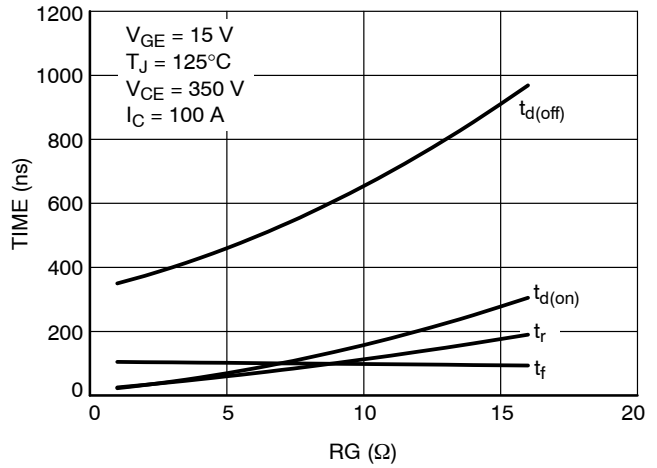

**Figure 10. Typical Switching Time vs. R<sub>G</sub>**

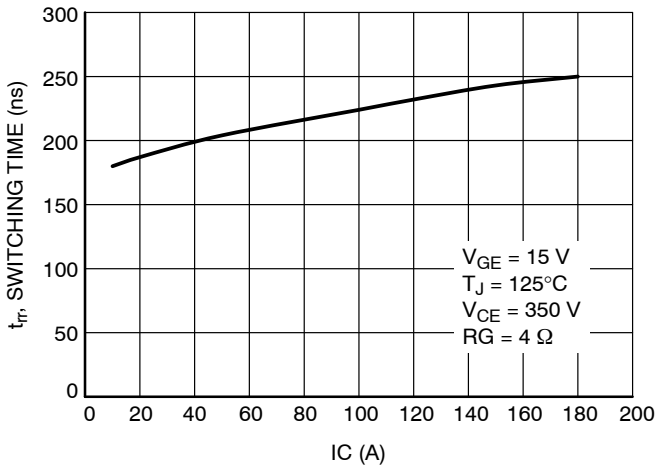

**Figure 11. Typical Reverse Recovery Time vs. IC**

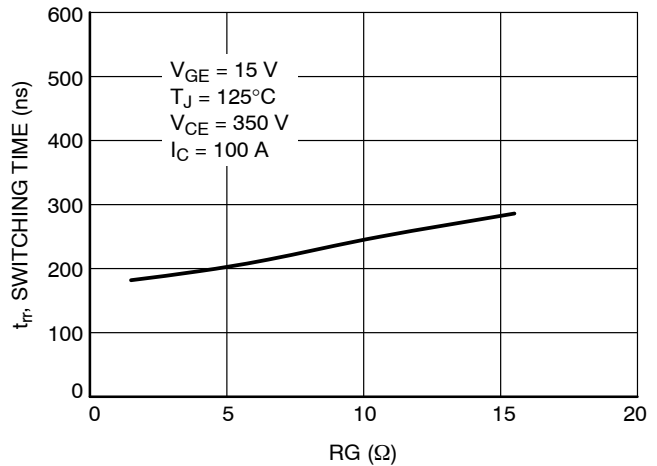

**Figure 12. Typical Reverse Recovery Time vs. R<sub>G</sub>**

# NXH160T120L2Q1PG, NXH160T120L2Q1SG

## TYPICAL CHARACTERISTICS – HALF BRIDGE IGBT AND NEUTRAL POINT FORWARD DIODE

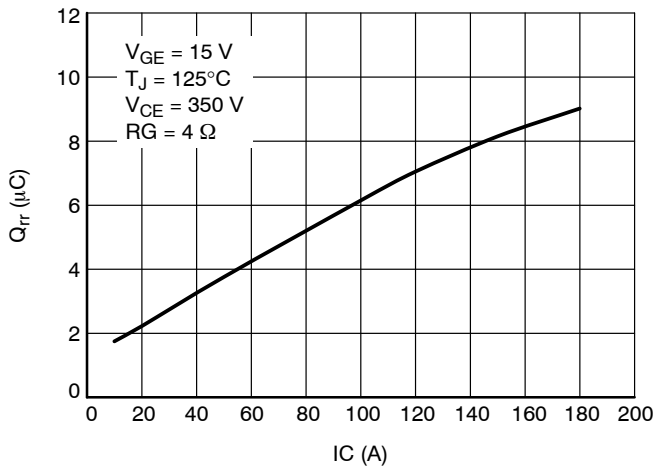

**Figure 13. Typical Reverse Recovery Charge vs. IC**

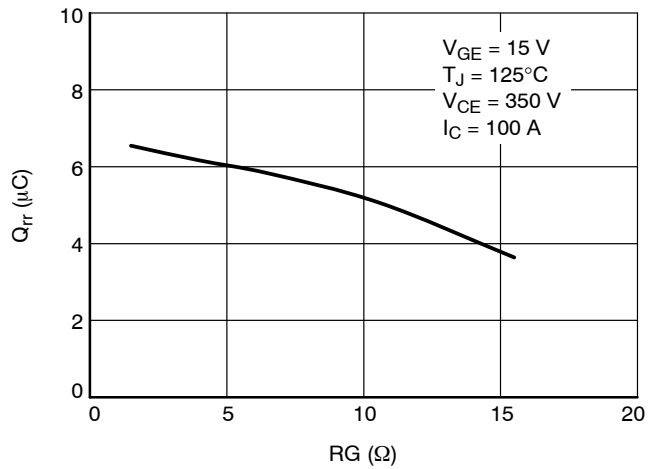

**Figure 14. Typical Reverse Recovery Charge vs. RG**

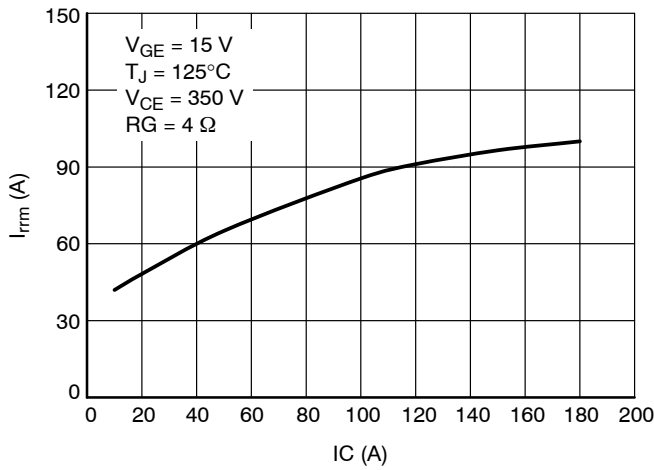

**Figure 15. Typical Reverse Recovery Current vs. IC**

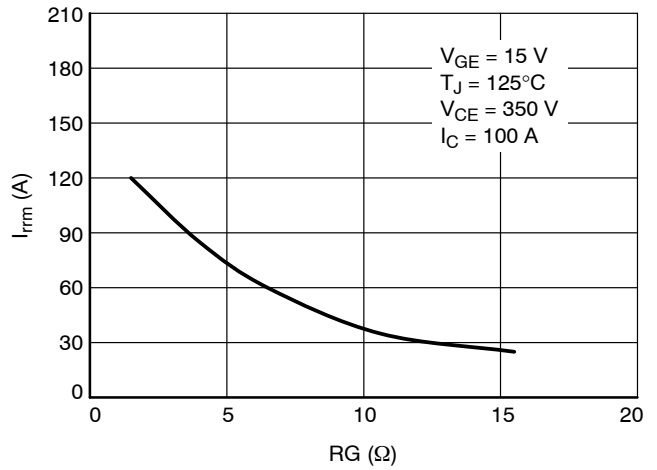

**Figure 16. Typical Reverse Recovery Current vs. RG**

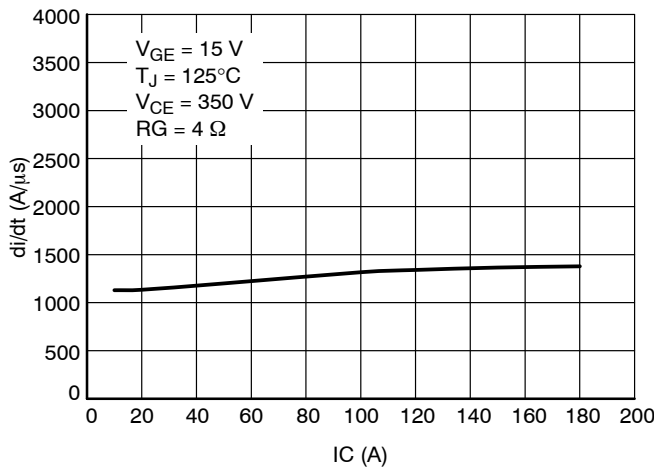

**Figure 17. Typical di/dt vs. IC**

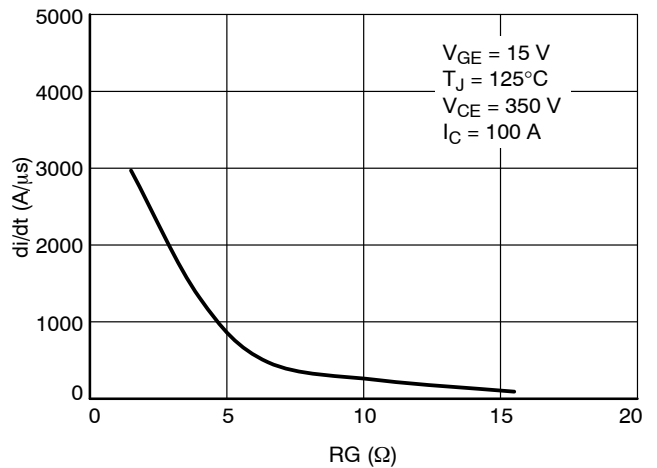

**Figure 18. Typical di/dt vs. RG**

# NXH160T120L2Q1PG, NXH160T120L2Q1SG

## TYPICAL CHARACTERISTICS – HALF BRIDGE IGBT AND NEUTRAL POINT FORWARD DIODE

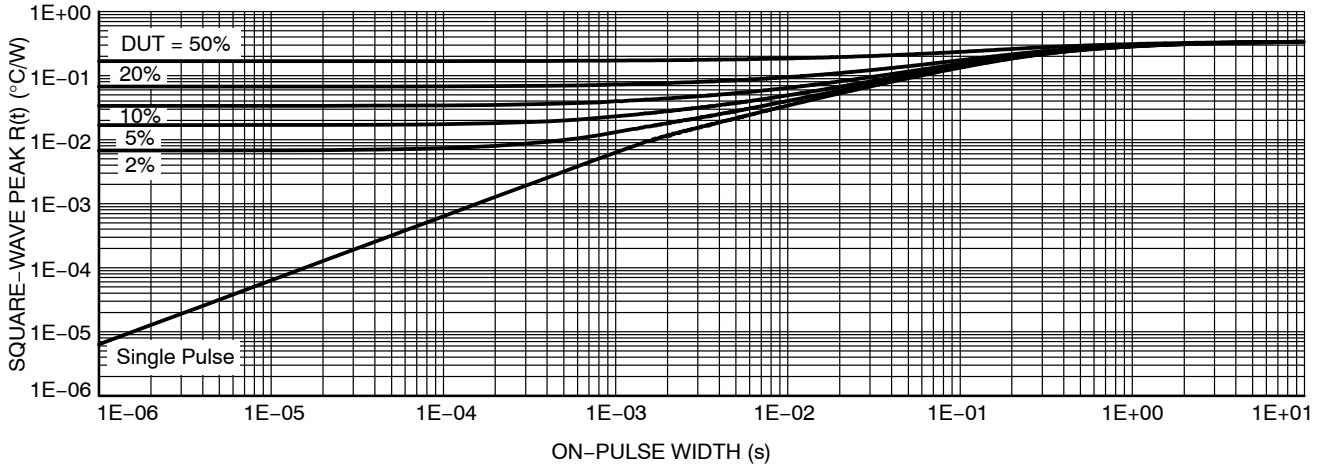

**Figure 19. Transient Thermal Impedance (Half Bridge IGBT)**

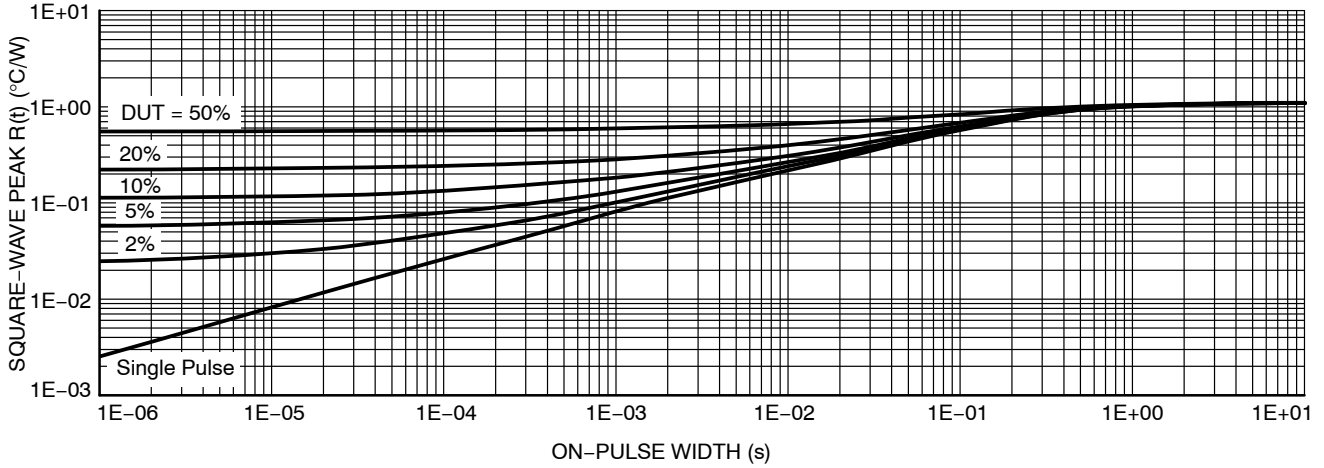

**Figure 20. Transient Thermal Impedance (Neutral Point Forward Diode)**

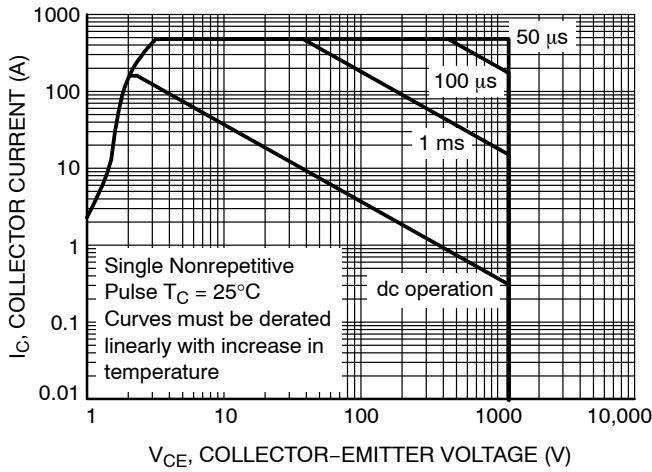

**Figure 21. Safe Operating Area**

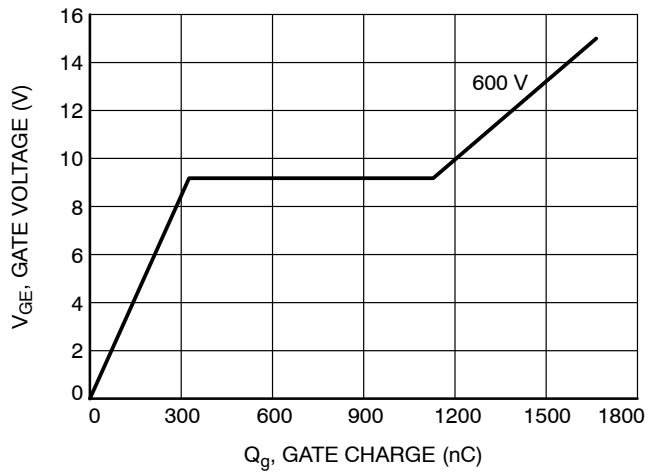
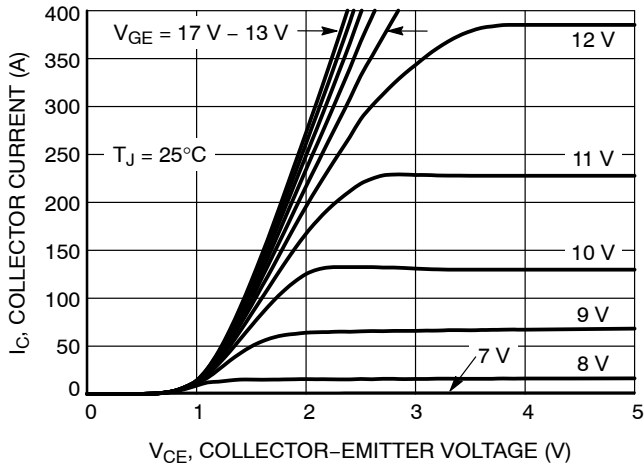

**Figure 22. Gate Voltage vs. Gate Charge**



# NXH160T120L2Q1PG, NXH160T120L2Q1SG

## TYPICAL CHARACTERISTICS – NEUTRAL POINT IGBT AND HALF BRIDGE FORWARD DIODE



**Figure 23. Typical Output Characteristics**

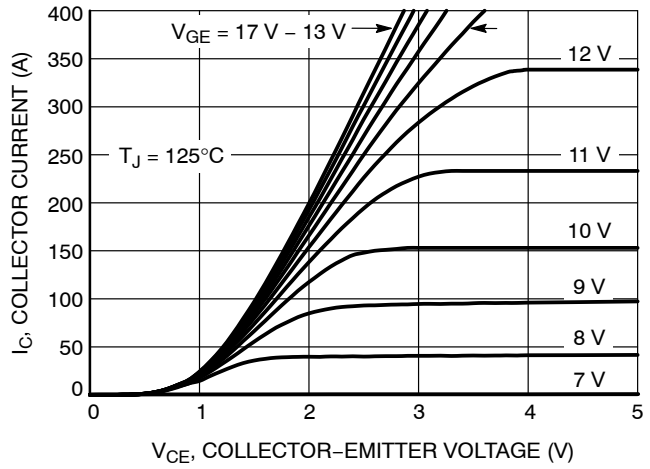

**Figure 24. Typical Output Characteristics**

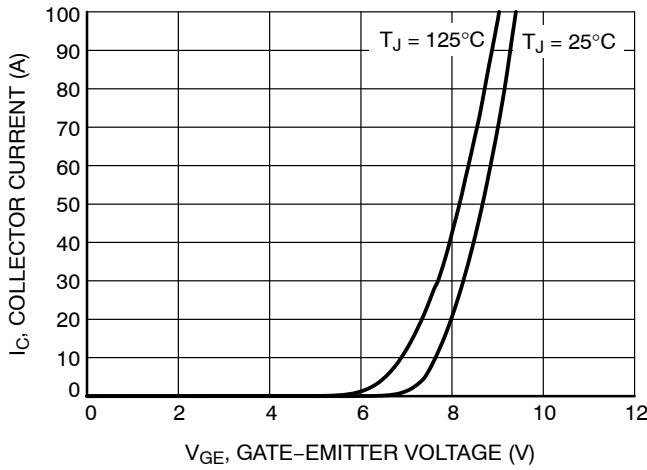

**Figure 25. Typical Transfer Characteristics**

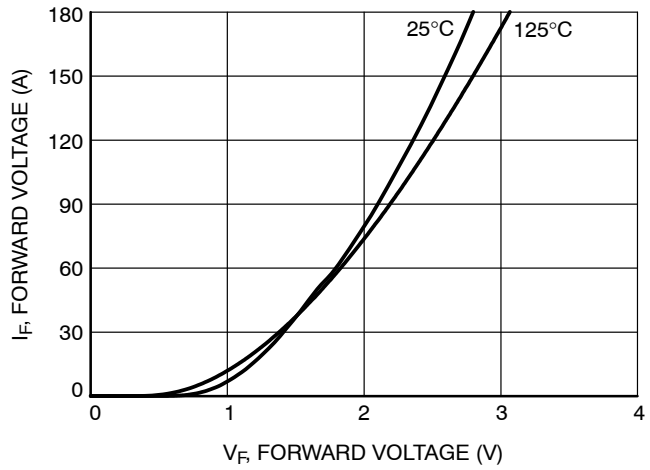

**Figure 26. Diode Forward Characteristics**

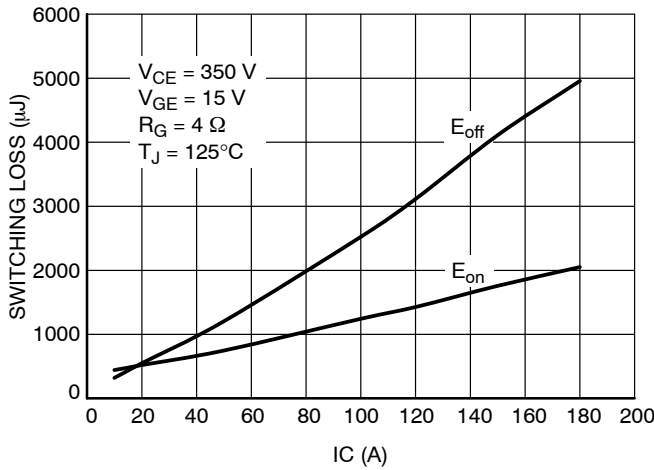

**Figure 27. Typical Switching Loss vs.  $I_C$**

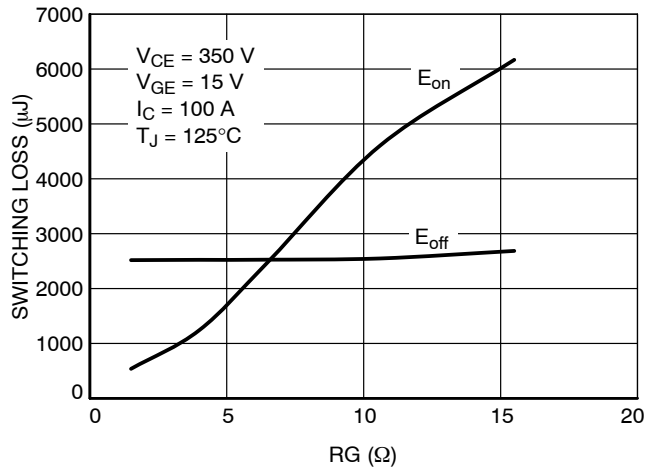

**Figure 28. Typical Switching Loss vs.  $R_G$**

# NXH160T120L2Q1PG, NXH160T120L2Q1SG

## TYPICAL CHARACTERISTICS – NEUTRAL POINT IGBT AND HALF BRIDGE FORWARD DIODE

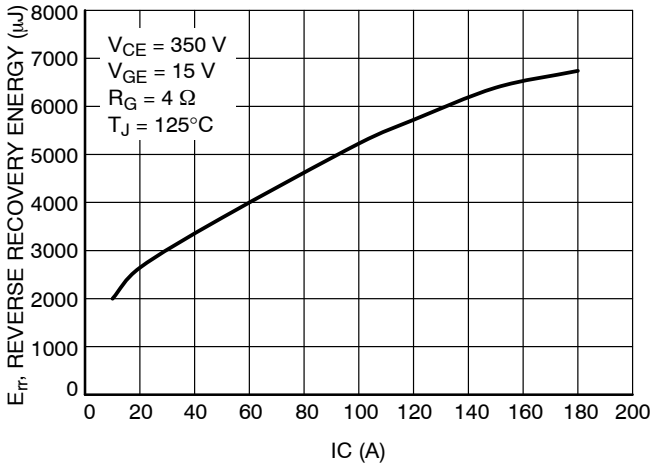

**Figure 29. Typical Reverse Recovery Energy Loss vs. IC**

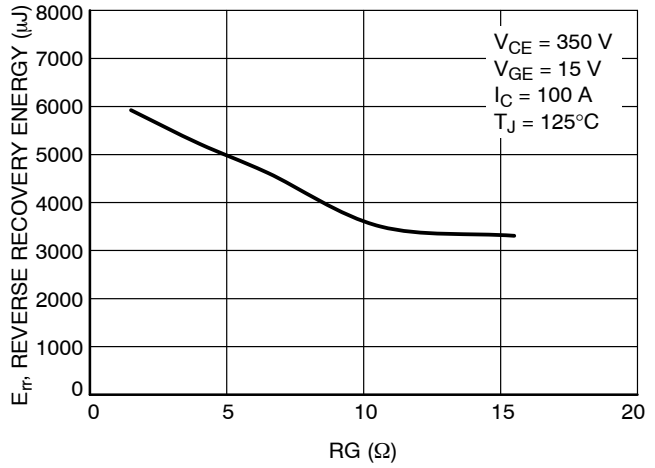

**Figure 30. Typical Reverse Recovery Energy Loss vs. R<sub>G</sub>**

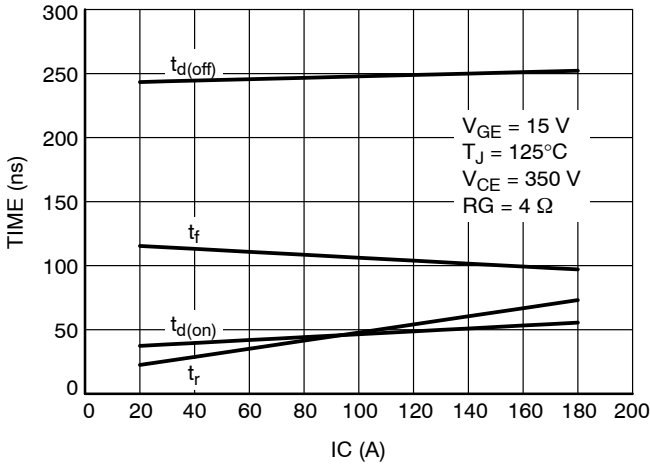

**Figure 31. Typical Switching Time vs. IC**

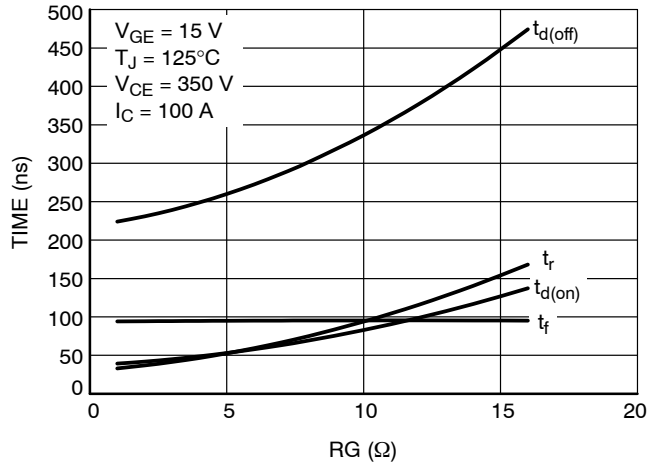

**Figure 32. Typical Switching Time vs. R<sub>G</sub>**

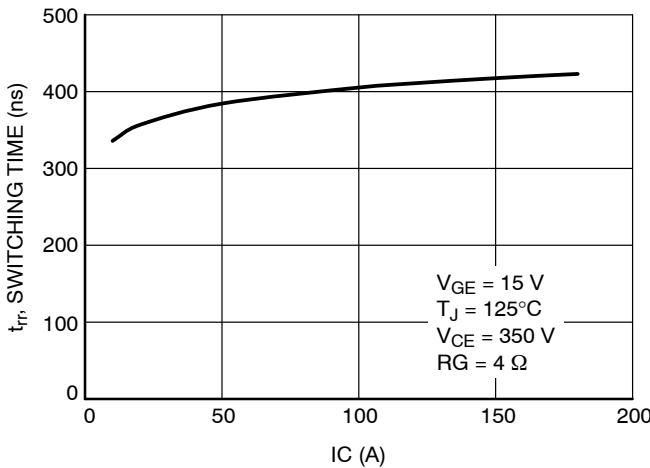

**Figure 33. Half Bridge Forward Diode Typical Reverse Recovery Time vs. IC**

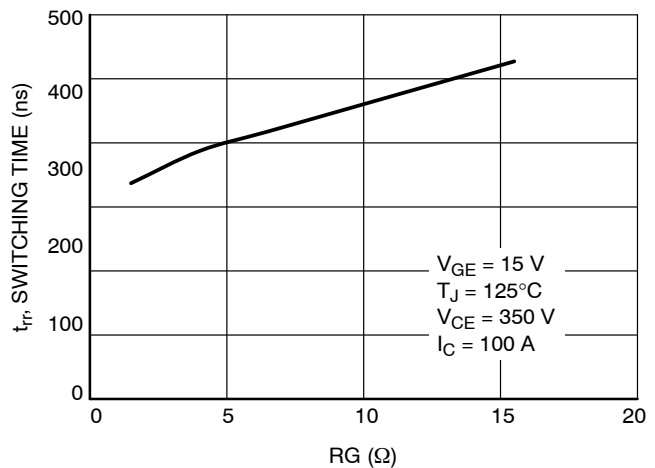

**Figure 34. Half Bridge Forward Diode Typical Reverse Recovery Time vs. R<sub>G</sub>**

# NXH160T120L2Q1PG, NXH160T120L2Q1SG

## TYPICAL CHARACTERISTICS – NEUTRAL POINT IGBT AND HALF BRIDGE FORWARD DIODE

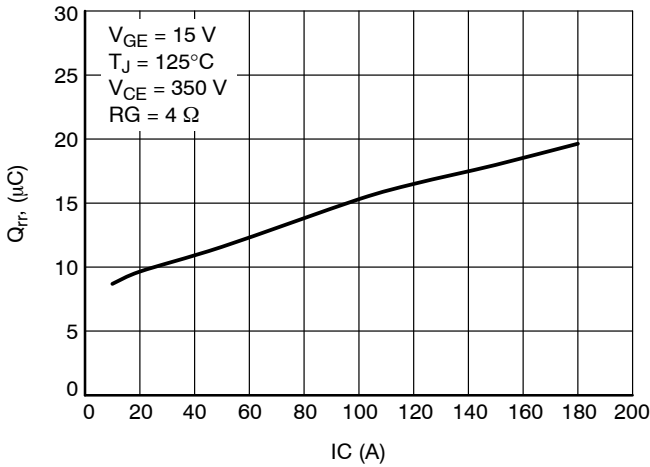

**Figure 35. Half Bridge Forward Diode Typical Reverse Recovery Charge vs. IC**

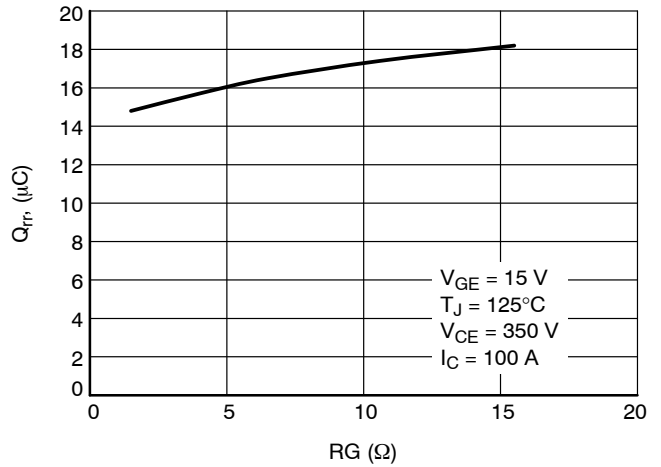

**Figure 36. Half Bridge Forward Diode Typical Reverse Recovery Charge vs. RG**

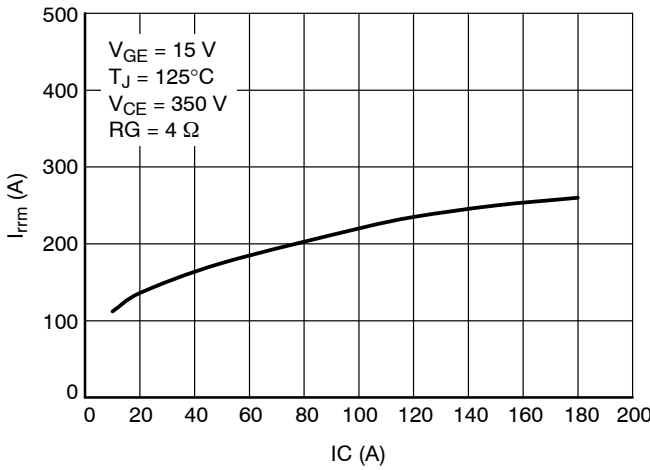

**Figure 37. Typical Reverse Recovery Current vs. IC**

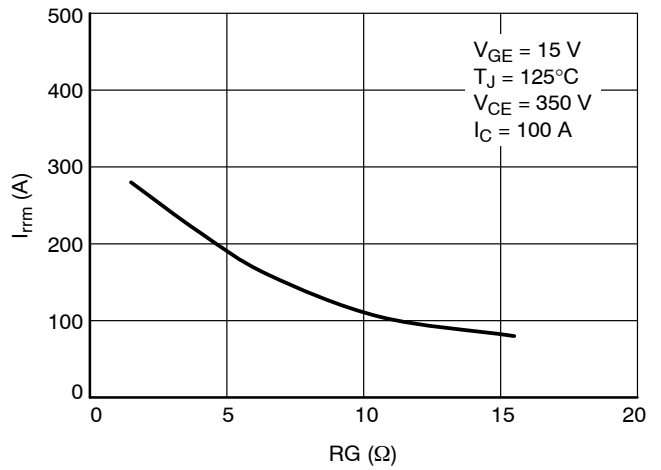

**Figure 38. Typical Reverse Recovery Current vs. RG**

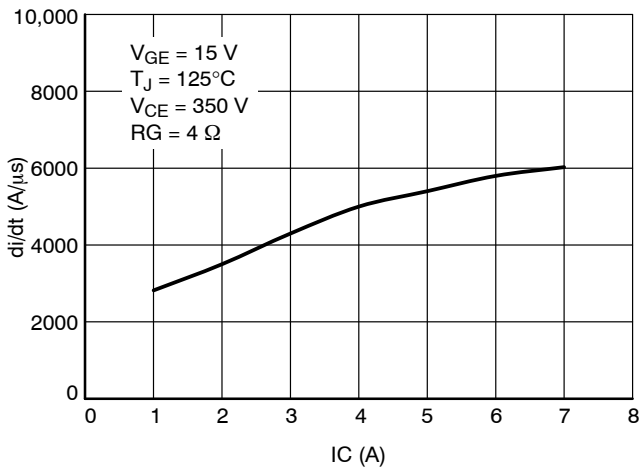

**Figure 39. Typical di/dt vs. IC**

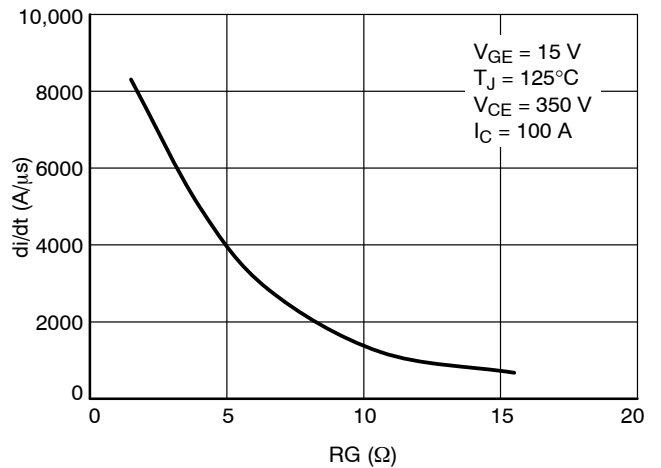

**Figure 40. Typical di/dt vs. RG**

# NXH160T120L2Q1PG, NXH160T120L2Q1SG

## TYPICAL CHARACTERISTICS – NEUTRAL POINT IGBT AND HALF BRIDGE FORWARD DIODE

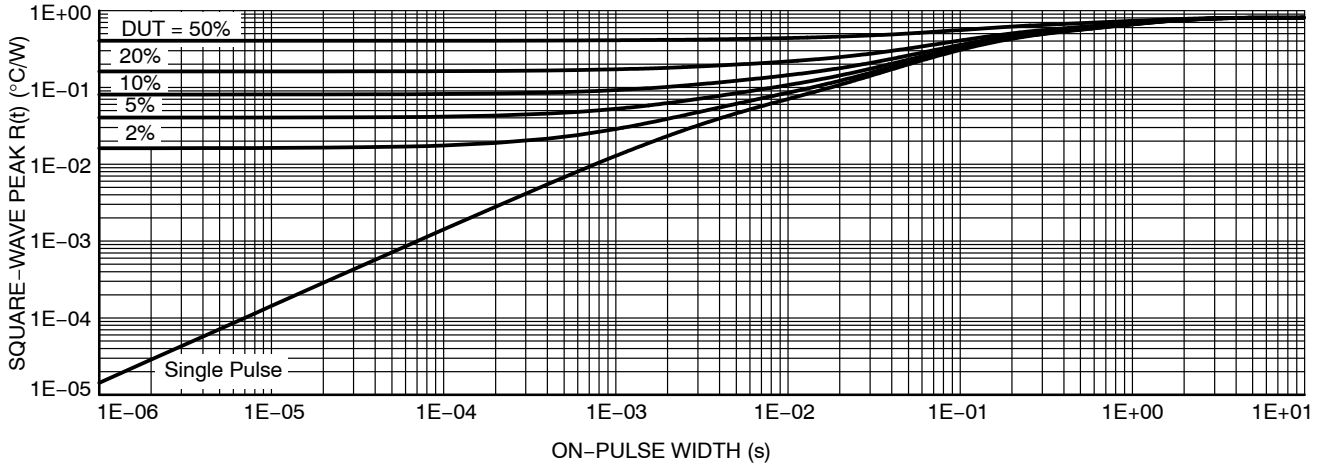

**Figure 41. Transient Thermal Impedance (Neutral Point IGBT)**

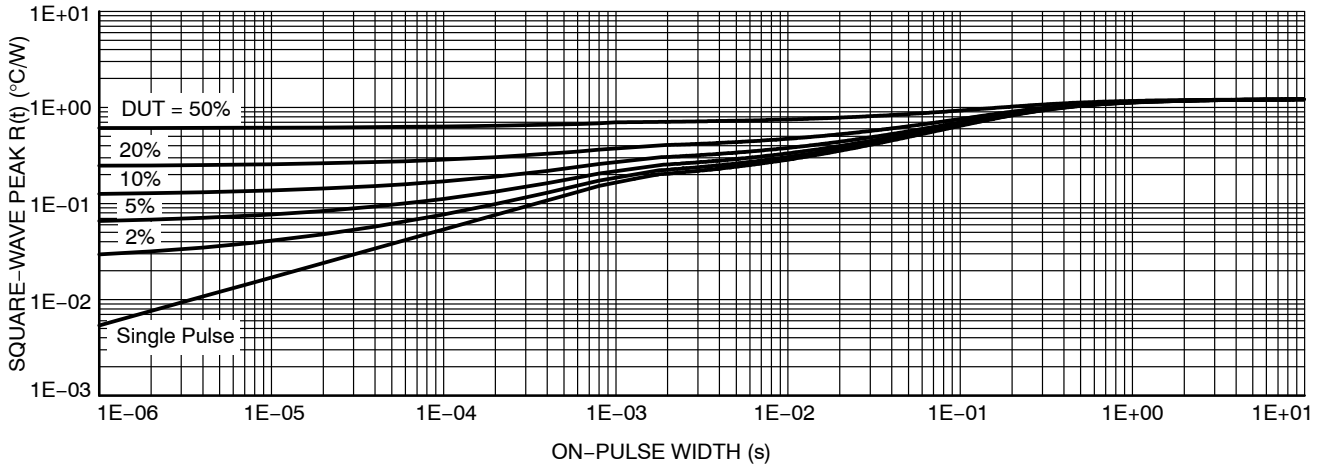

**Figure 42. Transient Thermal Impedance (Half Bridge Forward Diode)**

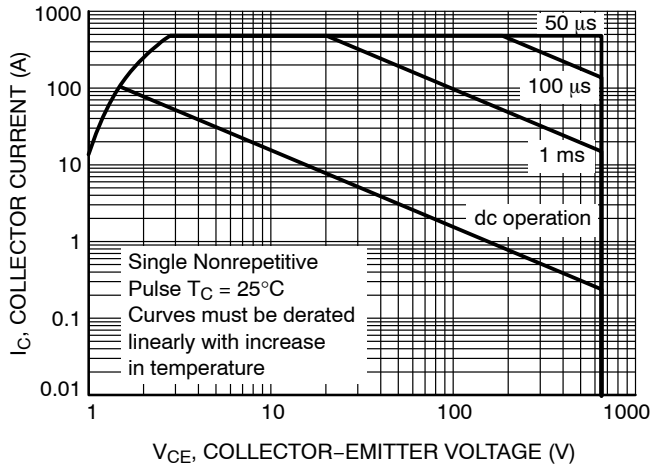

**Figure 43. Safe Operating Area**

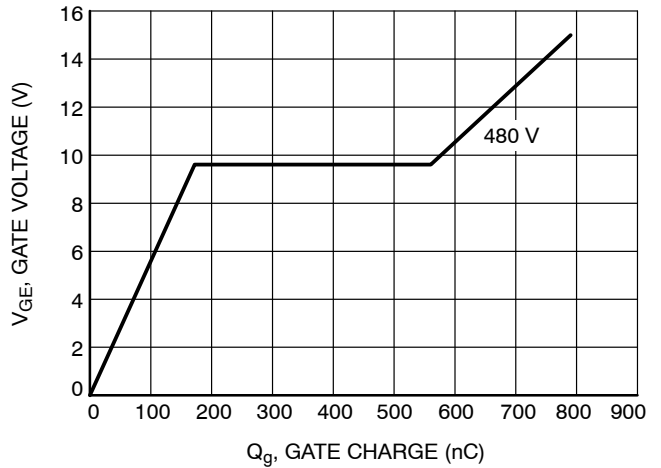

**Figure 44. Gate Voltage vs. Gate Charge**

# NXH160T120L2Q1PG, NXH160T120L2Q1SG

## TYPICAL CHARACTERISTICS – HALF BRIDGE INVERSE DIODE

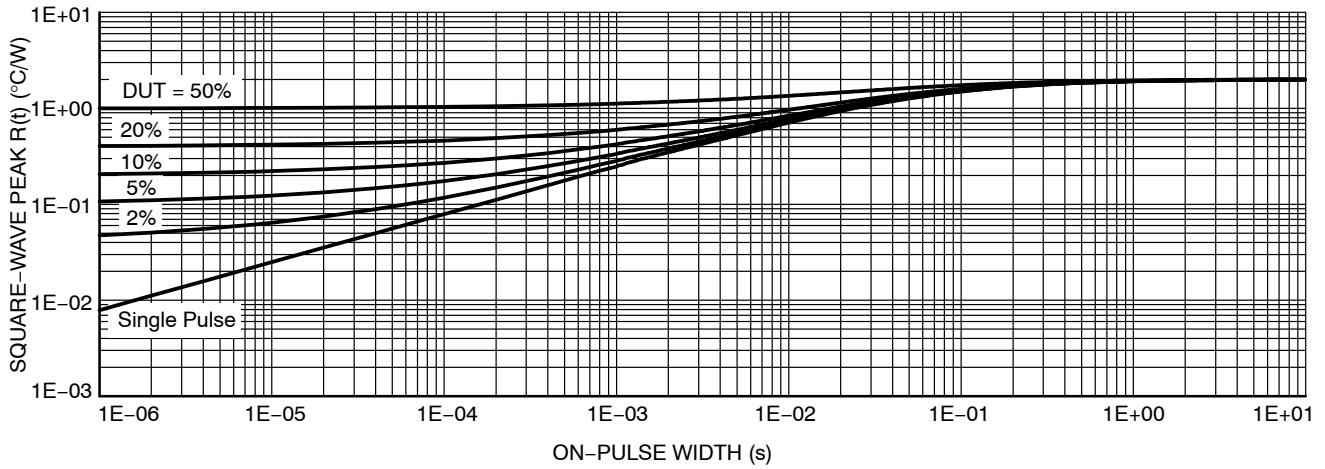

**Figure 45. Transient Thermal Impedance**

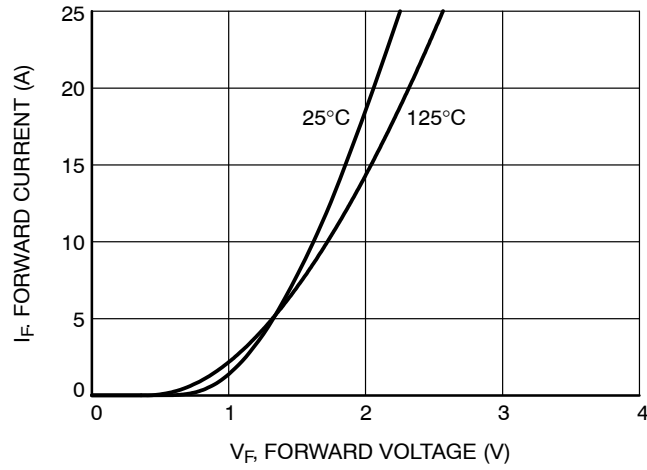

**Figure 46. Diode Forward Characteristics**

# NXH160T120L2Q1PG, NXH160T120L2Q1SG

## TYPICAL CHARACTERISTICS – NEUTRAL POINT INVERSE DIODE

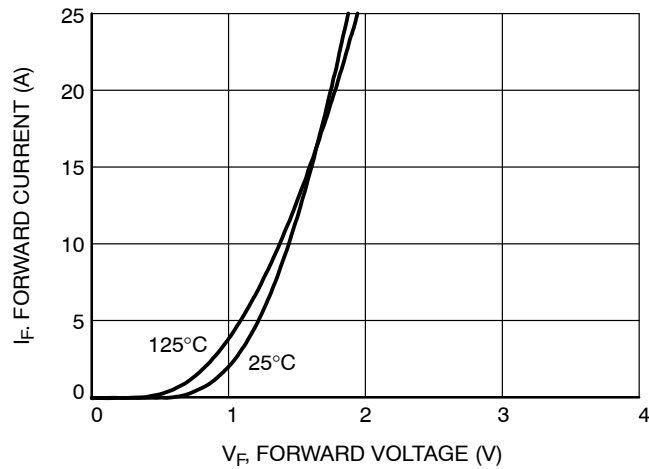

Figure 47. Diode Forward Characteristics

## TYPICAL CHARACTERISTICS – THERMISTOR

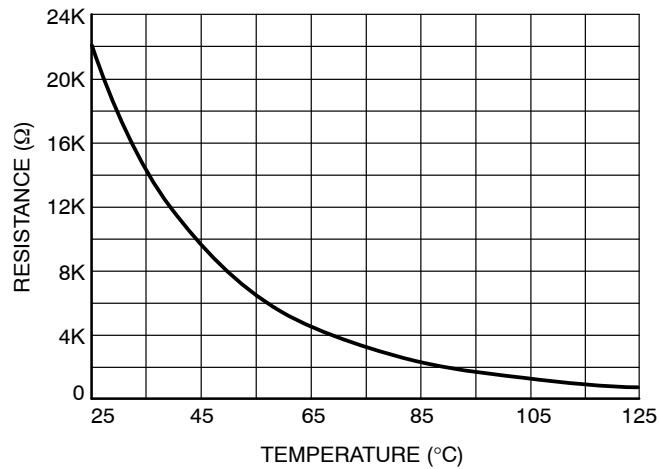

Figure 48. Thermistor Characteristics

### ORDERING INFORMATION

Orderable Part Number	Package	Shipping
NXH160T120L2Q1PG (Press Fit)	Q1PACK – Case 180AD (Pb-Free and Halide-Free)	21 Units / Blister Tray
NXH160T120L2Q1SG (Solder Pin)	Q1PACK – Case 180AQ (Pb-Free and Halide-Free)	21 Units / Blister Tray

# MECHANICAL CASE OUTLINE

## PACKAGE DIMENSIONS

ON Semiconductor®



PIM30, 71x37.4  
CASE 180AD  
ISSUE E

DATE 28 NOV 2017

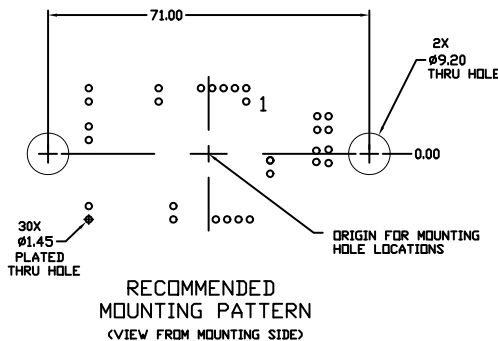
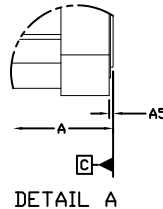
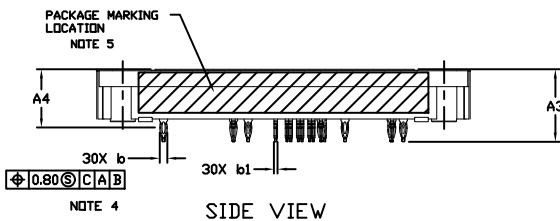
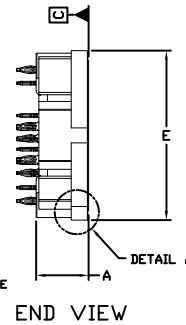
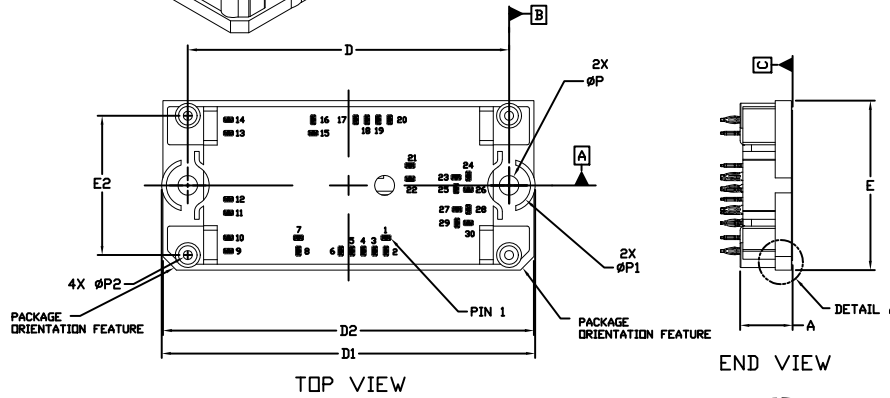
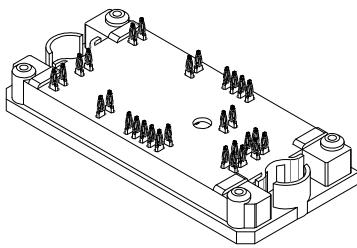

NOTES:

- DIMENSIONING AND TOLERANCING PER ASME Y14.5M, 2009.
- CONTROLLING DIMENSION: MILLIMETERS
- DIMENSIONS b AND b1 APPLY TO THE PLATED TERMINALS AND ARE MEASURED AT DIMENSION A4.
- POSITION OF THE CENTER OF THE TERMINALS IS DETERMINED FROM DATUM B THE CENTER OF DIMENSION D, X DIRECTION, AND FROM DATUM A, Y DIRECTION. POSITIONAL TOLERANCE, AS NOTED IN DRAWING, APPLIES TO EACH TERMINAL IN BOTH DIRECTIONS.
- PACKAGE MARKING IS LOCATED AS SHOWN ON THE SIDE OPPOSITE THE PACKAGE ORIENTATION FEATURES.

MOUNTING HOLE POSITION			MOUNTING HOLE POSITION		
PIN	X	Y	PIN	X	Y
1	8.30	11.55	16	-7.800	-14.50
2	8.30	14.50	17	1.60	-14.50
3	5.80	14.50	18	4.10	-14.50
4	3.30	14.50	19	6.60	-14.50
5	0.80	14.50	20	9.10	-14.50
6	-1.70	14.50	21	13.60	-4.40
7	-11.05	11.55	22	13.60	-1.45
8	-11.05	14.50	23	23.80	-1.80
9	-26.50	14.50	24	26.50	-2.05
10	-26.50	11.55	25	23.80	0.70
11	-26.50	6.05	26	26.50	0.95
12	-26.50	3.05	27	24.00	5.30
13	-26.50	-11.55	28	26.50	5.30
14	-26.50	-14.50	29	24.00	8.30
15	-7.80	-11.55	30	26.50	8.30

NOTE 4

DIM	MILLIMETERS	
	MIN.	NDM.
A	11.10	12.10
A3	15.50	16.50
A4	12.88	BSC
A5	0.00	0.45
b	1.61	1.71
b1	0.75	0.85
D	70.50	71.50
D1	82.00	83.00
D2	81.50	82.50
E	36.90	37.90
E2	30.30	31.30
P	4.30	4.50
P1	9.30	9.70
P2	1.90	2.10

PIN	PIN POSITION		PIN	PIN POSITION	
	X	Y		X	Y
1	8.30	-11.55	16	-7.800	14.50
2	8.30	-14.50	17	1.60	14.50
3	5.80	-14.50	18	4.10	14.50
4	3.30	-14.50	19	6.60	14.50
5	0.80	-14.50	20	9.10	14.50
6	-1.70	-14.50	21	13.60	4.40
7	-11.05	-11.55	22	13.60	1.45
8	-11.05	-14.50	23	23.80	1.80
9	-26.50	-14.50	24	26.50	2.05
10	-26.50	-11.55	25	23.80	-0.70
11	-26.50	-6.05	26	26.50	-0.95
12	-26.50	-3.05	27	24.00	-5.30
13	-26.50	11.55	28	26.50	-5.30
14	-26.50	14.50	29	24.00	-8.30
15	-7.80	11.55	30	26.50	-8.30

GENERIC

MARKING DIAGRAM\*

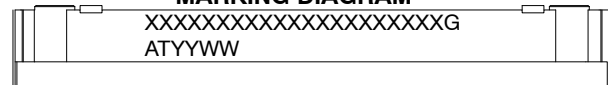

XXXXX = Specific Device Code  
G = Pb-Free Package  
AT = Assembly & Test Site Code  
YYWW = Year and Work Week Code

\*This information is generic. Please refer to device data sheet for actual part marking. Pb-Free indicator, "G" or microdot "•", may or may not be present. Some products may not follow the Generic Marking.

DOCUMENT NUMBER:	98AON07115G	Electronic versions are uncontrolled except when accessed directly from the Document Repository. Printed versions are uncontrolled except when stamped "CONTROLLED COPY" in red.
DESCRIPTION:	PIM30 71X37.4 (PRESS FIT)	PAGE 1 OF 1

ON Semiconductor and ON are trademarks of Semiconductor Components Industries, LLC dba ON Semiconductor or its subsidiaries in the United States and/or other countries. ON Semiconductor reserves the right to make changes without further notice to any products herein. ON Semiconductor makes no warranty, representation or guarantee regarding the suitability of its products for any particular purpose, nor does ON Semiconductor assume any liability arising out of the application or use of any product or circuit, and specifically disclaims any and all liability, including without limitation special, consequential or incidental damages. ON Semiconductor does not convey any license under its patent rights nor the rights of others.

# MECHANICAL CASE OUTLINE PACKAGE DIMENSIONS

ON Semiconductor®



**PIM30, 71x37.4**  
CASE 180AQ  
ISSUE A

DATE 25 JUN 2018

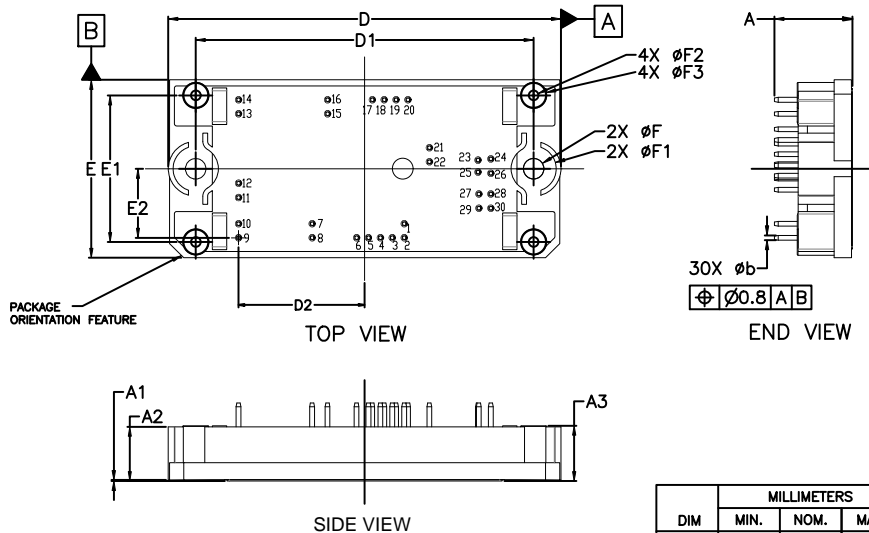
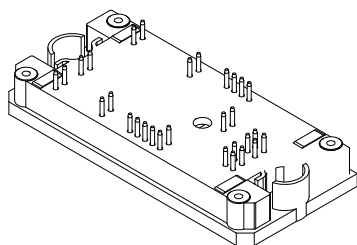

MOUNTING HOLE POSITION			MOUNTING HOLE POSITION		
PIN	X	Y	PIN	X	Y
1	8.30	11.55	16	-7.800	-14.50
2	8.30	14.50	17	1.60	-14.50
3	5.80	14.50	18	4.10	-14.50
4	3.30	14.50	19	6.60	-14.50
5	0.80	14.50	20	9.10	-14.50
6	-1.70	14.50	21	13.60	-4.40
7	-11.05	11.55	22	13.60	-1.45
8	-11.05	14.50	23	23.80	-1.80
9	-26.50	14.50	24	26.50	-2.05
10	-26.50	11.55	25	23.80	0.70
11	-26.50	6.05	26	26.50	0.95
12	-26.50	3.05	27	24.00	5.30
13	-26.50	-11.55	28	26.50	5.30
14	-26.50	-14.50	29	24.00	8.30
15	-7.80	-11.55	30	26.50	8.30

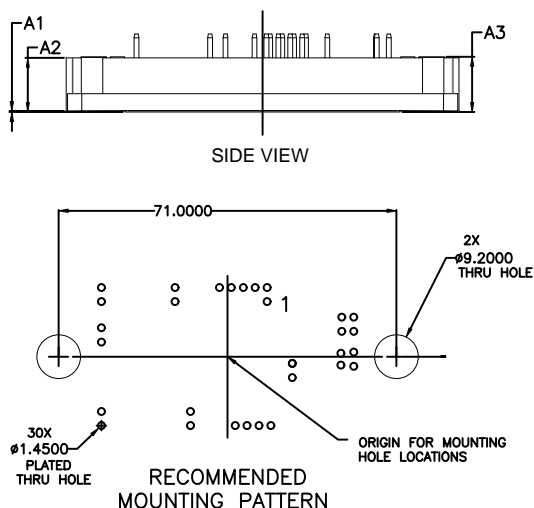

DIM	MILLIMETERS		
	MIN.	NOM.	MAX.
A	15.90	16.40	16.90
A1	---	0.30	0.60
A2	10.90	11.40	11.90
A3	11.10	11.60	12.10
b	0.90	1.00	1.10
D	82.00	82.50	83.00
D1	70.50	71.00	71.50
D2	26.50 REF		
E	36.90	37.40	37.90
E1	30.30	30.80	31.30
E2	14.50 REF		
F	4.30	4.30	4.50
F1	9.5 REF		
F2	2.0 REF		
F3	5.5 REF		

NOTE 4

PIN	PIN POSITION		PIN	PIN POSITION	
	X	Y		X	Y
1	8.30	-11.55	16	-7.800	14.50
2	8.30	-14.50	17	1.60	14.50
3	5.80	-14.50	18	4.10	14.50
4	3.30	-14.50	19	6.60	14.50
5	0.80	-14.50	20	9.10	14.50
6	-1.70	-14.50	21	13.60	4.40
7	-11.05	-11.55	22	13.60	1.45
8	-11.05	-14.50	23	23.80	1.80
9	-26.50	-14.50	24	26.50	2.05
10	-26.50	-11.55	25	23.80	-0.70
11	-26.50	-6.05	26	26.50	-0.95
12	-26.50	-3.05	27	24.00	-5.30
13	-26.50	11.55	28	26.50	-5.30
14	-26.50	14.50	29	24.00	-8.30
15	-7.80	11.55	30	26.50	-8.30

NOTES:

1. DIMENSIONING AND TOLERANCING PER ASME Y14.5M, 2009.
2. CONTROLLING DIMENSION: MILLIMETERS
3. DIMENSIONS b AND b1 APPLY TO THE PLATED TERMINALS AND ARE MEASURED AT DIMENSION A4.
4. POSITION OF THE CENTER OF THE TERMINALS IS DETERMINED FROM DATUM B THE CENTER OF DIMENSION D, X DIRECTION, AND FROM DATUM A, Y DIRECTION. POSITIONAL TOLERANCE, AS NOTED IN DRAWING, APPLIES TO EACH TERMINAL IN BOTH DIRECTIONS.
5. PACKAGE MARKING IS LOCATED AS SHOWN ON THE SIDE OPPOSITE THE PACKAGE ORIENTATION FEATURES.

GENERIC

MARKING DIAGRAM\*

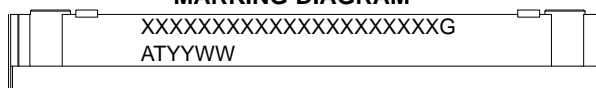

XXXXX = Specific Device Code  
G = Pb-Free Package  
AT = Assembly & Test Site Code  
YYWW = Year and Work Week Code

\*This information is generic. Please refer to device data sheet for actual part marking. Pb-Free indicator, "G" or microdot "▪", may or may not be present. Some products may not follow the Generic Marking.

<b>DOCUMENT NUMBER:</b>	<b>98AON86769G</b>	Electronic versions are uncontrolled except when accessed directly from the Document Repository. Printed versions are uncontrolled except when stamped "CONTROLLED COPY" in red.
<b>DESCRIPTION:</b>	<b>PIM30, 71x37.4</b>	<b>PAGE 1 OF 1</b>

ON Semiconductor and are trademarks of Semiconductor Components Industries, LLC dba ON Semiconductor or its subsidiaries in the United States and/or other countries. ON Semiconductor reserves the right to make changes without further notice to any products herein. ON Semiconductor makes no warranty, representation or guarantee regarding the suitability of its products for any particular purpose, nor does ON Semiconductor assume any liability arising out of the application or use of any product or circuit, and specifically disclaims any and all liability, including without limitation special, consequential or incidental damages. ON Semiconductor does not convey any license under its patent rights nor the rights of others.



**onsemi**, **Onsemi**, and other names, marks, and brands are registered and/or common law trademarks of Semiconductor Components Industries, LLC dba "**onsemi**" or its affiliates and/or subsidiaries in the United States and/or other countries. **onsemi** owns the rights to a number of patents, trademarks, copyrights, trade secrets, and other intellectual property. A listing of **onsemi**'s product/patent coverage may be accessed at [www.onsemi.com/site/pdf/Patent-Marking.pdf](http://www.onsemi.com/site/pdf/Patent-Marking.pdf). **onsemi** reserves the right to make changes at any time to any products or information herein, without notice. The information herein is provided "as-is" and **onsemi** makes no warranty, representation or guarantee regarding the accuracy of the information, product features, availability, functionality, or suitability of its products for any particular purpose, nor does **onsemi** assume any liability arising out of the application or use of any product or circuit, and specifically disclaims any and all liability, including without limitation special, consequential or incidental damages. Buyer is responsible for its products and applications using **onsemi** products, including compliance with all laws, regulations and safety requirements or standards, regardless of any support or applications information provided by **onsemi**. "Typical" parameters which may be provided in **onsemi** data sheets and/or specifications can and do vary in different applications and actual performance may vary over time. All operating parameters, including "Typicals" must be validated for each customer application by customer's technical experts. **onsemi** does not convey any license under any of its intellectual property rights nor the rights of others. **onsemi** products are not designed, intended, or authorized for use as a critical component in life support systems or any FDA Class 3 medical devices or medical devices with a same or similar classification in a foreign jurisdiction or any devices intended for implantation in the human body. Should Buyer purchase or use **onsemi** products for any such unintended or unauthorized application, Buyer shall indemnify and hold **onsemi** and its officers, employees, subsidiaries, affiliates, and distributors harmless against all claims, costs, damages, and expenses, and reasonable attorney fees arising out of, directly or indirectly, any claim of personal injury or death associated with such unintended or unauthorized use, even if such claim alleges that **onsemi** was negligent regarding the design or manufacture of the part. **onsemi** is an Equal Opportunity/Affirmative Action Employer. This literature is subject to all applicable copyright laws and is not for resale in any manner.

## PUBLICATION ORDERING INFORMATION

### LITERATURE FULFILLMENT:

Email Requests to: [orderlit@onsemi.com](mailto:orderlit@onsemi.com)

**onsemi Website:** [www.onsemi.com](http://www.onsemi.com)

### TECHNICAL SUPPORT

**North American Technical Support:**

Voice Mail: 1 800-282-9855 Toll Free USA/Canada

Phone: 011 421 33 790 2910

**Europe, Middle East and Africa Technical Support:**

Phone: 00421 33 790 2910

For additional information, please contact your local Sales Representative