

SiC Power MOSFET Module

**1200 V, 40 mΩ, 27 A
H-Bridge Power Module**

NVXK2TR40WXT

Features

- DIP Silicon Carbide H-Bridge Power Module for On-board Charger (OBC) for xEV Applications
- Creepage and Clearance per IEC 60664-1, IEC 60950-1
- Compact Design for Low Total Module Resistance
- Module Serialization for Full Traceability
- Lead Free, ROHS and UL94V-0 Compliant
- Automotive Qualified per AEC-Q101 and AQG324

Typical Applications

- DC-DC and On-Board Charger in xEV Applications

MAXIMUM RATINGS (T_J = 25°C unless otherwise noted)

Parameter	Symbol	Value	Unit	
Drain-to-Source Voltage	V _{DSS}	1200	V	
Gate-to-Source Voltage	V _{GS}	+25/-15	V	
Recommended Operation Values of Gate-to-Source Voltage, T _J ≤ 175°C	V _{GSop}	+20/-5	V	
Continuous Drain Current (Notes 1, 2)	T _C = 25°C	I _D	27	A
Power Dissipation (Note 1)		P _D	319	W
Pulsed Drain Current (Note 3)	T _C = 25°C	I _{DM}	240	A
Single Pulse Surge Drain Current Capability	T _C = 25°C, t _p = 10 μs, R _G = 4.7 Ω	I _{DSC}	495	A
Operating Junction and Storage Temperature	T _J , T _{stg}	-55 to 175	°C	
Source Current (Body Diode) (Note 2)	I _S	27	A	
Single Pulse Drain-to-Source Avalanche Energy (Note 4)	E _{AS}	338	mJ	

Stresses exceeding those listed in the Maximum Ratings table may damage the device. If any of these limits are exceeded, device functionality should not be assumed, damage may occur and reliability may be affected.

1. Particular conditions specified determine thermal resistance values shown. Infinite heatsink with T_C = 100°C for R_{θJC}. For R_{ψJS} assembled to 3 mm thick aluminum heatsink with infinite cooling bottom surface at 85°C, through 38 μm thick TIM with 6.5 W/mK thermal conductivity.
2. Qualified per ECPE Guideline AQG 324.
3. Repetitive rating limited by maximum junction temperature and transconductance.
4. E_{AS} based on initial T_J = 25°C, L = 1 mH, I_{AS} = 26 A, V_{DD} = 120 V, V_{GS} = 18 V.

V _{(BR)DSS}	R _{DS(on)} Max	I _D Max
1200 V	59 mΩ @ 20 V	27 A

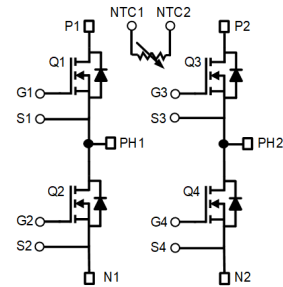

SiC MOSFET H-Bridge Module

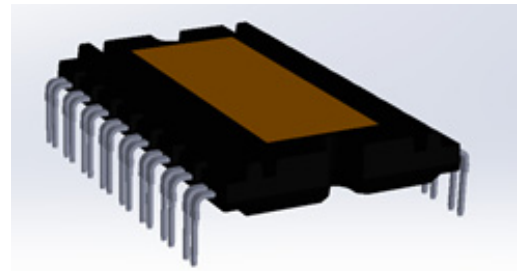

APM32

ORDERING INFORMATION

Device	Package	Shipping
NVXK2TR40WXT	APM32 (Pb-Free)	10 ea / Tube

NVXK2TR40WXT

THERMAL CHARACTERISTICS (Note 1)

Parameter	Symbol	Typ	Max	Unit
Thermal Resistance Junction-to-Case (Note 1)	$R_{\theta JC}$	0.37	0.47	$^{\circ}C/W$
Thermal Resistance Junction-to-Sink (Note 1)	$R_{\psi JS}$	0.84	0.95	$^{\circ}C/W$

ELECTRICAL CHARACTERISTICS ($T_J = 25^{\circ}C$ unless otherwise stated)

Parameter	Symbol	Test Conditions	Min	Typ	Max	Unit
-----------	--------	-----------------	-----	-----	-----	------

OFF CHARACTERISTICS

Drain-to-Source Breakdown Voltage	$V_{(BR)DSS}$	$V_{GS} = 0 V, I_D = 1 mA$	1200			V
Drain-to-Source Breakdown Voltage Temperature Coefficient	$V_{(BR)DSS} / T_J$	$I_D = 1 mA$, referenced to $25^{\circ}C$		450		$mV/^{\circ}C$
Zero Gate Voltage Drain Current	I_{DSS}	$V_{GS} = 0 V$ $V_{DS} = 1200 V$	$T_J = 25^{\circ}C$		100	μA
			$T_J = 175^{\circ}C$		1	mA
Gate-to-Source Leakage Current	I_{GSS}	$V_{GS} = +25/-15 V, V_{DS} = 0 V$			± 1	μA

ON CHARACTERISTICS (Note 5)

Gate Threshold Voltage	$V_{GS(TH)}$	$V_{GS} = V_{DS}, I_D = 10 mA$	1.8	3	4.3	V
Recommended Gate Voltage	V_{GOP}		-5		+20	V
Drain-to-Source On Resistance	$R_{DS(on)}$	$V_{GS} = 20 V, I_D = 35 A, T_J = 25^{\circ}C$		40	59	$m\Omega$
Drain-to-Source On Resistance	$R_{DS(on)}$	$V_{GS} = 20 V, I_D = 35 A, T_J = 175^{\circ}C$		71		$m\Omega$
Forward Transconductance	g_{FS}	$V_{DS} = 20 V, I_D = 35 A$		20		S

CHARGES, CAPACITANCES & GATE RESISTANCE

Input Capacitance	C_{ISS}	$V_{GS} = 0 V, f = 1 MHz,$ $V_{DS} = 800 V$		1789		pF
Output Capacitance	C_{OSS}			139		
Reverse Transfer Capacitance	C_{RSS}			12.5		
Total Gate Charge	$Q_{G(TOT)}$	$V_{GS} = -5/20 V, V_{DS} = 600 V,$ $I_D = 47 A$		106		nC
Threshold Gate Charge	$Q_{G(TH)}$			18		
Gate-to-Source Charge	Q_{GS}			34		
Gate-to-Drain Charge	Q_{GD}			26		
Gate-Resistance	R_G		$V_{GS} = 0 V, f = 1 MHz$		2	

INDUCTIVE SWITCHING CHARACTERISTICS

Turn-On Delay Time	$t_{d(ON)}$	$V_{GS} = -5 / 20 V, V_{DS} = 800 V,$ $I_D = 47 A, R_G = 4.7 \Omega,$ Inductive load		17		ns	
Rise Time	t_r			20			
Turn-Off Delay Time	$t_{d(OFF)}$			30			
Fall Time	t_f			9			
Turn-On Switching Loss	E_{ON}			366			μJ
Turn-Off Switching Loss	E_{OFF}			200			μJ
Total Switching Loss	E_{tot}			566			μJ

DRAIN-SOURCE DIODE CHARACTERISTICS

Continuous Drain-Source Diode Forward Current (Note 1)	I_{SD}	$V_{GS} = -5 V, T_J = 25^{\circ}C$			27	A
Pulsed Drain-Source Diode Forward Current (Note 3)	I_{SDM}	$V_{GS} = -5 V, T_J = 25^{\circ}C$			240	A
Forward Diode Voltage	V_{SD}	$V_{GS} = -5 V, I_{SD} = 17.5 A,$ $T_J = 25^{\circ}C$		3.7		V

NVXK2TR40WXT

ELECTRICAL CHARACTERISTICS ($T_J = 25^\circ\text{C}$ unless otherwise stated) (continued)

Parameter	Symbol	Test Conditions	Min	Typ	Max	Unit
DRAIN-SOURCE DIODE CHARACTERISTICS						
Reverse Recovery Time	t_{RR}	$V_{GS} = -5\text{ V}$, $di_S/dt = 1000\text{ A}/\mu\text{s}$, $I_{SD} = 17.5\text{ A}$		24		ns
Peak Reverse Recovery Current	I_{RRM}			10.4		A
Charge Time	t_a			12.4		ns
Discharge Time	t_b			11.6		ns
Reverse Recovery Charge	Q_{RR}			125		nC

Product parametric performance is indicated in the Electrical Characteristics for the listed test conditions, unless otherwise noted. Product performance may not be indicated by the Electrical Characteristics if operated under different conditions.

5. Pulse test: pulse width $\leq 300\ \mu\text{s}$, duty ratio $\leq 2\%$.

NVXK2TR40WXT

TYPICAL CHARACTERISTICS

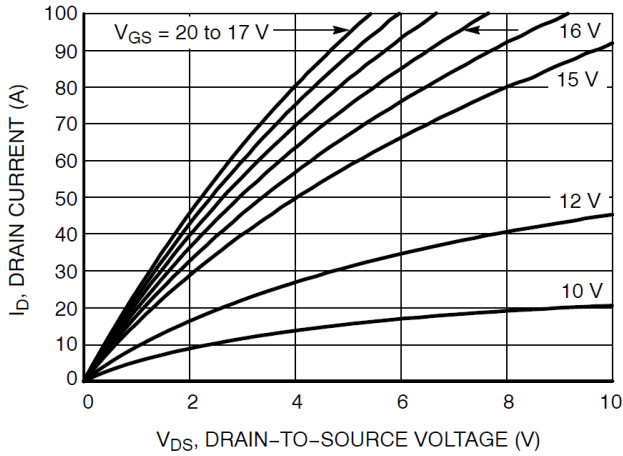

Figure 1. On-Region Characteristics

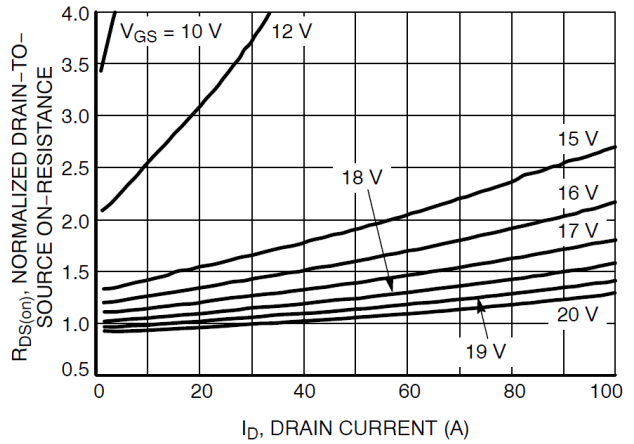

Figure 2. Normalized On-Resistance vs. Drain Current and Gate Voltage

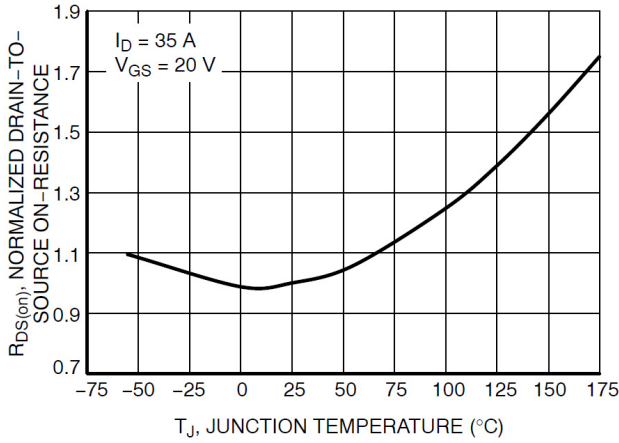

Figure 3. On-Resistance Variation with Temperature

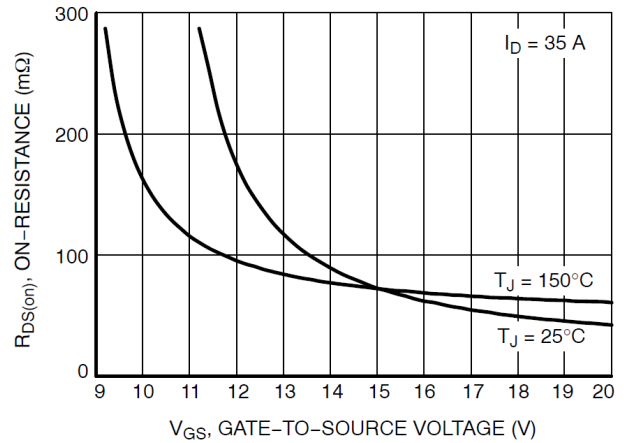

Figure 4. On-Resistance vs. Gate-to-Source Voltage

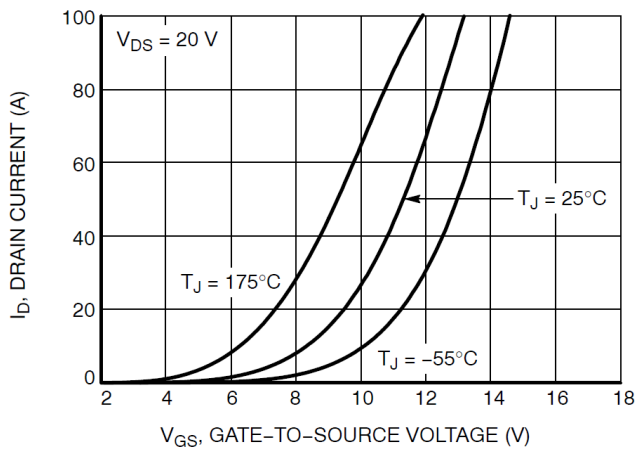

Figure 5. Transfer Characteristics

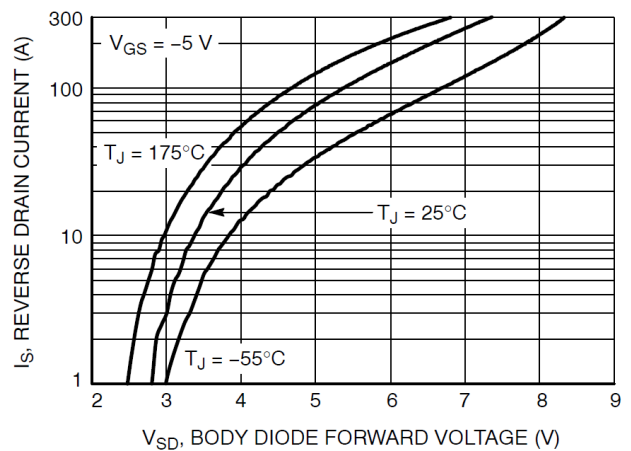

Figure 6. Diode Forward Voltage vs. Current

NVXK2TR40WXT

TYPICAL CHARACTERISTICS (CONTINUED)

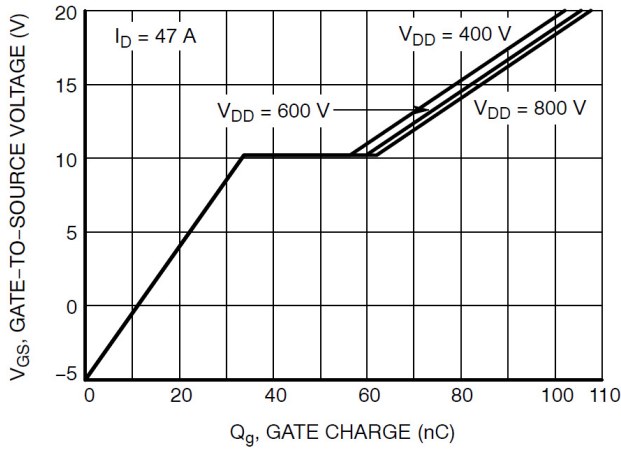

Figure 7. Gate-to-Source Voltage vs. Total Charge

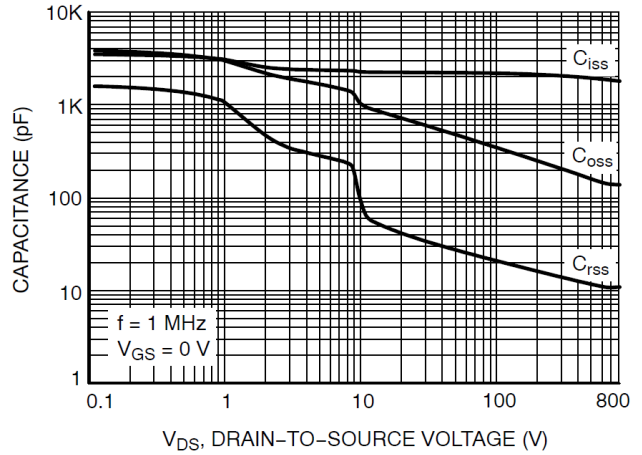

Figure 8. Capacitance vs. Drain-to-Source Voltage

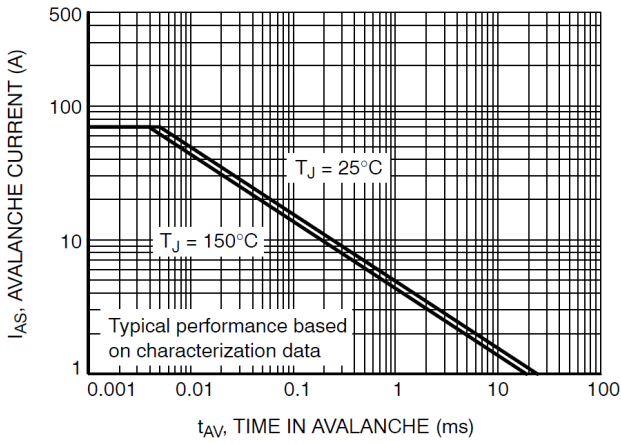

Figure 9. Unclamped Inductive Switching Capability

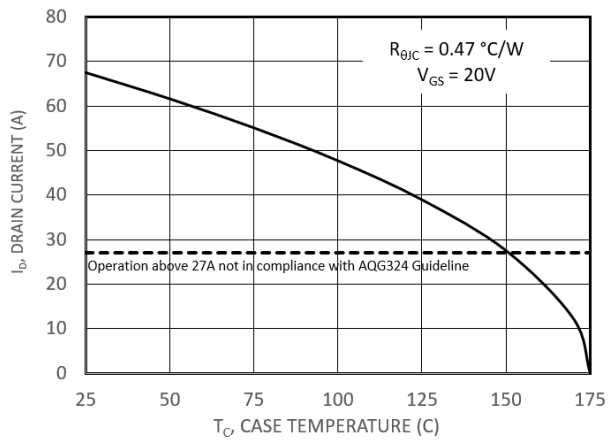

Figure 10. Maximum Continuous Drain Current vs. Case Temperature

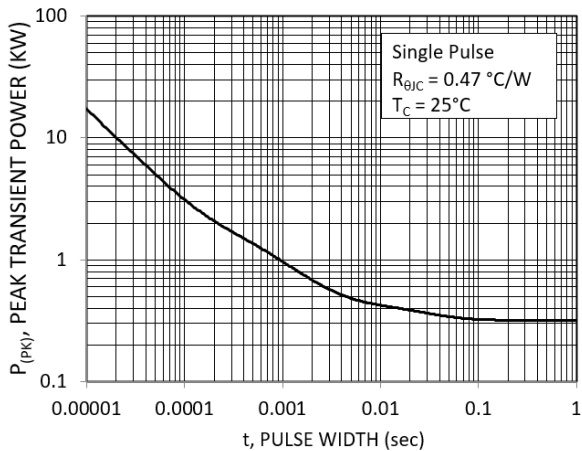

Figure 11. Single Pulse Maximum Power Dissipation

NVXK2TR40WXT

TYPICAL CHARACTERISTICS (CONTINUED)

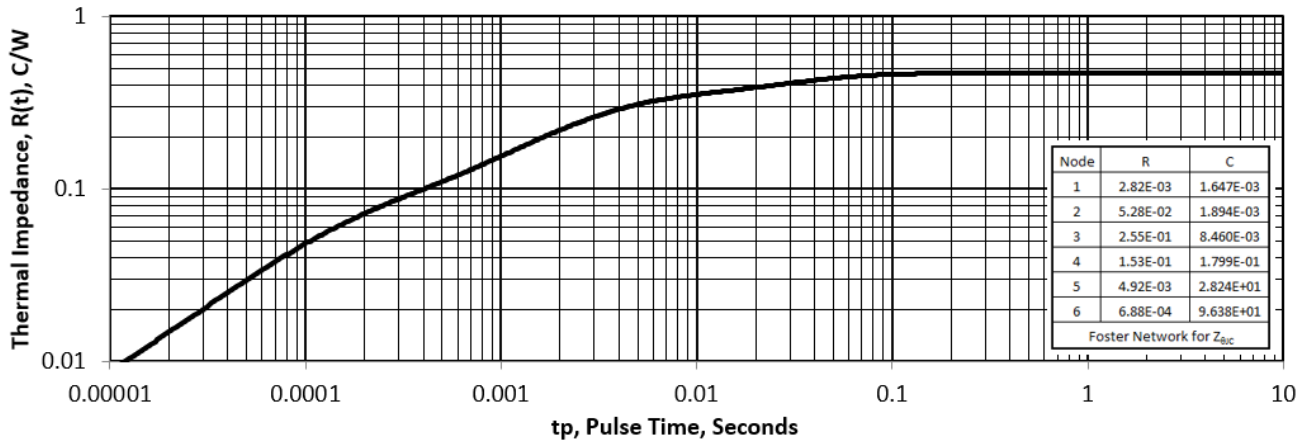

Figure 12. Thermal Response

onsemi, **Onsemi**, and other names, marks, and brands are registered and/or common law trademarks of Semiconductor Components Industries, LLC dba "**onsemi**" or its affiliates and/or subsidiaries in the United States and/or other countries. **onsemi** owns the rights to a number of patents, trademarks, copyrights, trade secrets, and other intellectual property. A listing of **onsemi**'s product/patent coverage may be accessed at www.onsemi.com/site/pdf/Patent-Marking.pdf. **onsemi** reserves the right to make changes at any time to any products or information herein, without notice. The information herein is provided "as-is" and **onsemi** makes no warranty, representation or guarantee regarding the accuracy of the information, product features, availability, functionality, or suitability of its products for any particular purpose, nor does **onsemi** assume any liability arising out of the application or use of any product or circuit, and specifically disclaims any and all liability, including without limitation special, consequential or incidental damages. Buyer is responsible for its products and applications using **onsemi** products, including compliance with all laws, regulations and safety requirements or standards, regardless of any support or applications information provided by **onsemi**. "Typical" parameters which may be provided in **onsemi** data sheets and/or specifications can and do vary in different applications and actual performance may vary over time. All operating parameters, including "Typicals" must be validated for each customer application by customer's technical experts. **onsemi** does not convey any license under any of its intellectual property rights nor the rights of others. **onsemi** products are not designed, intended, or authorized for use as a critical component in life support systems or any FDA Class 3 medical devices or medical devices with a same or similar classification in a foreign jurisdiction or any devices intended for implantation in the human body. Should Buyer purchase or use **onsemi** products for any such unintended or unauthorized application, Buyer shall indemnify and hold **onsemi** and its officers, employees, subsidiaries, affiliates, and distributors harmless against all claims, costs, damages, and expenses, and reasonable attorney fees arising out of, directly or indirectly, any claim of personal injury or death associated with such unintended or unauthorized use, even if such claim alleges that **onsemi** was negligent regarding the design or manufacture of the part. **onsemi** is an Equal Opportunity/Affirmative Action Employer. This literature is subject to all applicable copyright laws and is not for resale in any manner.

PUBLICATION ORDERING INFORMATION

LITERATURE FULFILLMENT:

Email Requests to: orderlit@onsemi.com

onsemi Website: www.onsemi.com

TECHNICAL SUPPORT

North American Technical Support:

Voice Mail: 1 800-282-9855 Toll Free USA/Canada

Phone: 011 421 33 790 2910

Europe, Middle East and Africa Technical Support:

Phone: 00421 33 790 2910

For additional information, please contact your local Sales Representative