

MOSFET - Power, Single P-Channel, WDFN8 -30 V

NVTFS012P03P8Z, NVTFWS012P03P8Z

Features

- Small Footprint for Compact Design
- Low $R_{DS(on)}$ to Minimize Conduction Losses
- AEC-Q101 Qualified
- These Devices are Pb-Free, Halogen-Free/BFR-Free and are RoHS Compliant

Applications

- Battery Management
- Protection
- Power Load Switch

MAXIMUM RATINGS ($T_J = 25^\circ\text{C}$ unless otherwise noted)

Parameter	Symbol	Value	Unit	
Drain-to-Source Voltage	V_{DSS}	-30	V	
Gate-to-Source Voltage	V_{GS}	± 25	V	
Continuous Drain Current $R_{\theta JA}$ (Notes 1, 3)	Steady State	$T_A = 25^\circ\text{C}$	I_D -11.7	A
		$T_A = 85^\circ\text{C}$	-8.4	
Power Dissipation $R_{\theta JA}$ (Notes 1, 3)		$T_A = 25^\circ\text{C}$	P_D 2.40	W
Continuous Drain Current $R_{\theta JA}$ (Notes 2, 3)	Steady State	$T_A = 25^\circ\text{C}$	I_D -7.0	A
		$T_A = 85^\circ\text{C}$	-5.1	
Power Dissipation $R_{\theta JA}$ (Notes 2, 3)		$T_A = 25^\circ\text{C}$	P_D 0.86	W
Pulsed Drain Current	$T_A = 25^\circ\text{C}, t_p = 10 \mu\text{s}$	I_{DM} 47	A	
Operating Junction and Storage Temperature Range	T_J, T_{stg}	-55 to +175	$^\circ\text{C}$	
Lead Temperature for Soldering Purposes (1/8" from case for 10 s)	T_L	260	$^\circ\text{C}$	

Stresses exceeding those listed in the Maximum Ratings table may damage the device. If any of these limits are exceeded, device functionality should not be assumed, damage may occur and reliability may be affected.

THERMAL RESISTANCE MAXIMUM RATINGS (Note 1)

Parameter	Symbol	Value	Unit
Junction-to-Ambient - Steady State (Note 1)	$R_{\theta JA}$	52	$^\circ\text{C}/\text{W}$
Junction-to-Ambient - Steady State (Note 2)	$R_{\theta JA}$	145	

1. Surface-mounted on FR4 board using 1 in² pad size, 2 oz. Cu pad.
2. Surface-mounted on FR4 board using minimum pad size, 2 oz. Cu pad.
3. The entire application environment impacts the thermal resistance values shown, they are not constants and are only valid for the particular conditions noted. Actual continuous current will be limited by thermal & electro-mechanical application board design. $R_{\theta CA}$ is determined by the user's board design.

$V_{(BR)DSS}$	$R_{DS(on)}$ MAX	I_D MAX
-30 V	11.3 m Ω @ -10 V	-11.7 A
	20 m Ω @ -4.5 V	

ELECTRICAL CONNECTION

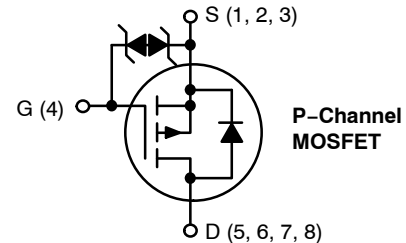

WDFN8
($\mu 8\text{FL}$)
CASE 511AB

MARKING DIAGRAMS

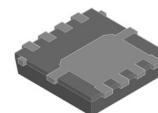
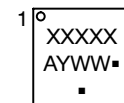

WDFNW8
($\mu 8\text{FL WF}$)
CASE 515AN

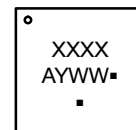

- XXXX = Specific Device Code
- A = Assembly Location
- Y = Year
- WW = Work Week
- = Pb-Free Package

(Note: Microdot may be in either location)

ORDERING INFORMATION

See detailed ordering, marking and shipping information on page 5 of this data sheet.

NVTFS012P03P8Z, NVTFWS012P03P8Z

ELECTRICAL CHARACTERISTICS (T_J = 25°C unless otherwise noted)

Parameter	Symbol	Test Condition	Min	Typ	Max	Unit
-----------	--------	----------------	-----	-----	-----	------

OFF CHARACTERISTICS

Drain-to-Source Breakdown Voltage	V _{(BR)DSS}	V _{GS} = 0 V, I _D = -250 μA	-30			V
Drain-to-Source Breakdown Voltage Temperature Coefficient	V _{(BR)DSS} /T _J	I _D = -250 μA, ref to 25°C		-9.9		mV/°C
Zero Gate Voltage Drain Current	I _{DSS}	V _{GS} = 0 V, V _{DS} = -30 V, T _J = 25°C			-10	μA
Gate-to-Source Leakage Current	I _{GSS}	V _{DS} = 0 V, V _{GS} = ±25 V			±10	μA

ON CHARACTERISTICS (Note 4)

Gate Threshold Voltage	V _{GS(TH)}	V _{GS} = V _{DS} , I _D = -250 μA	-1.0		-3.0	V
Threshold Temperature Coefficient	V _{GS} /T _J	I _D = -250 μA, ref to 25°C		-4.7		mV/°C
Drain-to-Source On Resistance	R _{DS(on)}	V _{GS} = -10 V, I _D = -10 A		8.3	11.3	mΩ
		V _{GS} = -4.5 V, I _D = -10 A		13.3	20	
Forward Transconductance	g _{FS}	V _{DS} = -5 V, I _D = -10 A		41		S

CHARGES AND CAPACITANCES

Input Capacitance	C _{iss}	V _{GS} = 0 V, V _{DS} = -15 V, f = 1.0 MHz		1535		pF
Output Capacitance	C _{oss}			526		
Reverse Transfer Capacitance	C _{rss}			506		
Total Gate Charge	Q _{G(TOT)}	V _{GS} = -4.5 V, V _{DS} = -15 V, I _D = -10 A		21		nC
Threshold Gate Charge	Q _{G(TH)}			1.4		
Gate-to-Source Charge	Q _{GS}			2.8		
Gate-to-Drain Charge	Q _{GD}			14.8		
Total Gate Charge	Q _{G(TOT)}	V _{GS} = -10 V, V _{DS} = -15 V, I _D = -10 A		36		nC

SWITCHING CHARACTERISTICS, V_{GS} = 4.5 V (Note 5)

Turn-On Delay Time	t _{d(on)}	V _{GS} = -4.5 V, V _{DD} = -15 V, I _D = -10 A, R _G = 6 Ω		15		ns
Rise Time	t _r			66		
Turn-Off Delay Time	t _{d(off)}			48		
Fall Time	t _f			77		

SWITCHING CHARACTERISTICS, V_{GS} = 10 V (Note 5)

Turn-On Delay Time	t _{d(on)}	V _{GS} = -10 V, V _{DD} = -15 V, I _D = -10 A, R _G = 6 Ω		7		ns
Rise Time	t _r			17		
Turn-Off Delay Time	t _{d(off)}			89		
Fall Time	t _f			75		

DRAIN-SOURCE DIODE CHARACTERISTICS

Forward Diode Voltage	V _{SD}	V _{GS} = 0 V, I _S = -10 A	T _J = 25°C	0.82	1.3	V
			T _J = 125°C	0.7		
Reverse Recovery Time	t _{RR}	V _{GS} = 0 V, dI _S /dt = -100 A/μs, I _S = -10 A		19		ns
Reverse Recovery Charge	Q _{RR}			10		nC

Product parametric performance is indicated in the Electrical Characteristics for the listed test conditions, unless otherwise noted. Product performance may not be indicated by the Electrical Characteristics if operated under different conditions.

4. Pulse Test: Pulse Width ≤ 300 μs, Duty Cycle ≤ 2%.

5. Switching characteristics are independent of operating junction temperatures.

TYPICAL CHARACTERISTICS

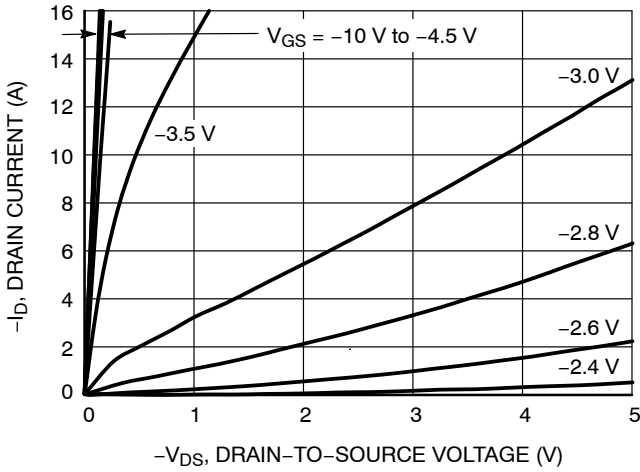

Figure 1. On-Region Characteristics

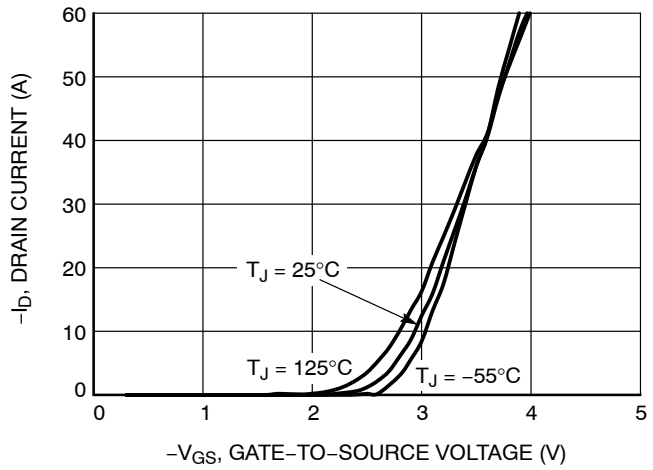

Figure 2. Transfer Characteristics

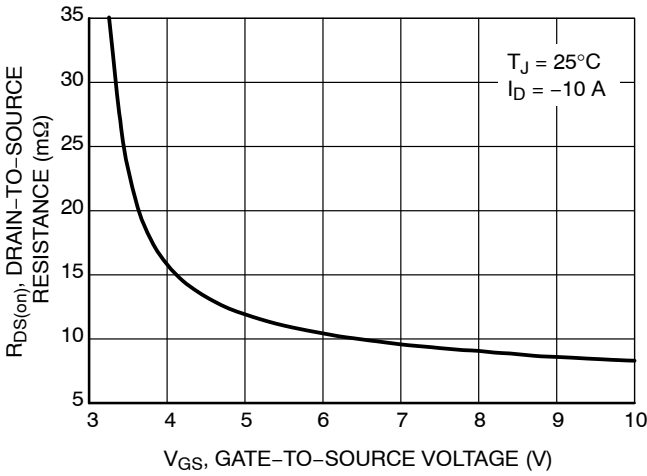

Figure 3. On-Resistance vs. Gate-to-Source Voltage (V)

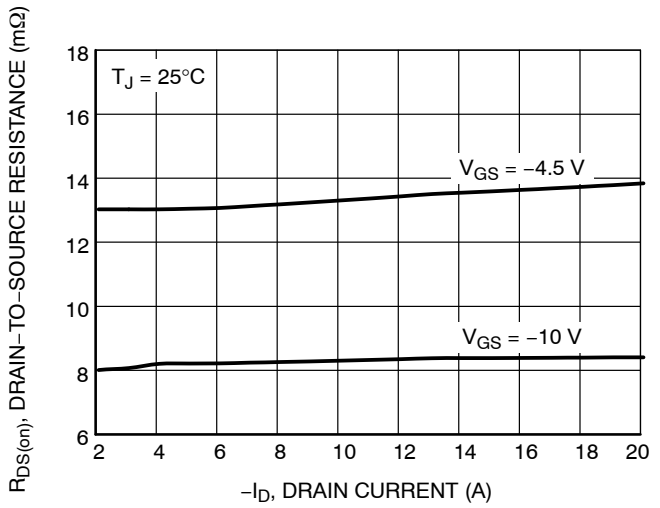

Figure 4. On-Resistance vs. Drain Current and Gate Voltage

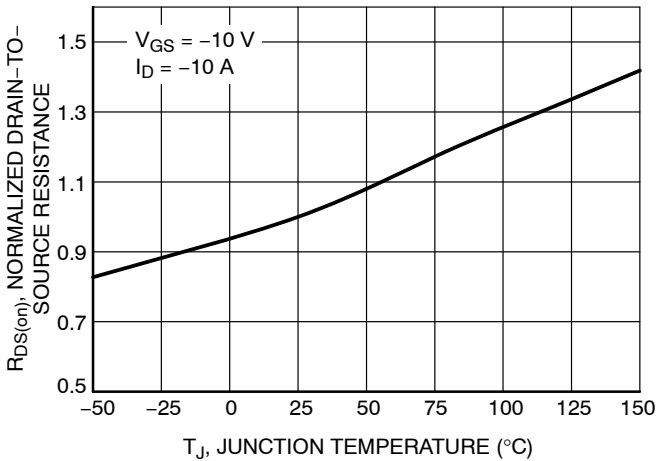

Figure 5. On-Resistance Variation with Temperature

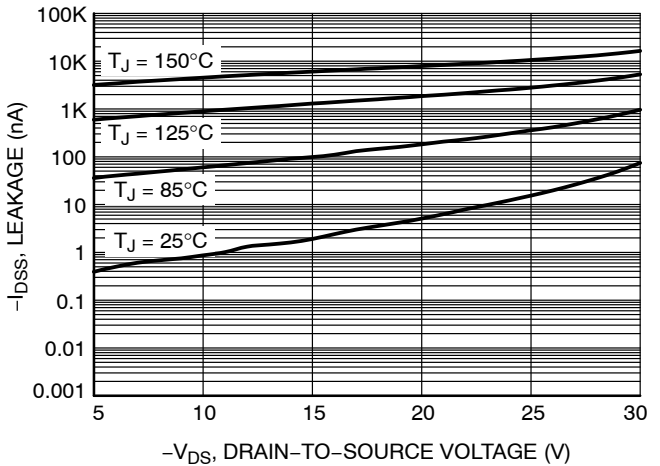

Figure 6. Drain-to-Source Leakage Current vs. Voltage

NVTFS012P03P8Z, NVTFWS012P03P8Z

TYPICAL CHARACTERISTICS

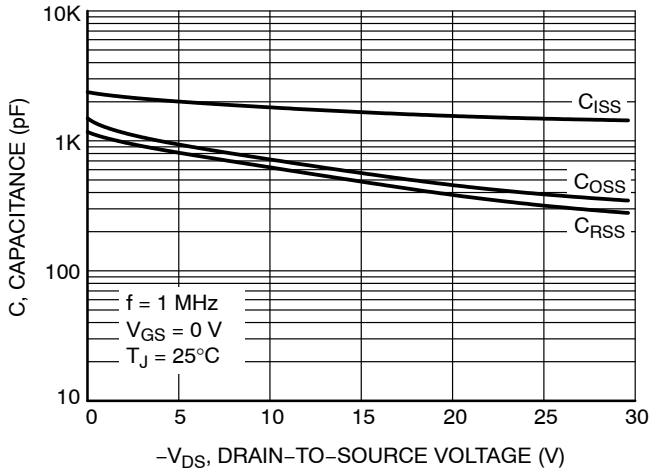

Figure 7. Capacitance Variation

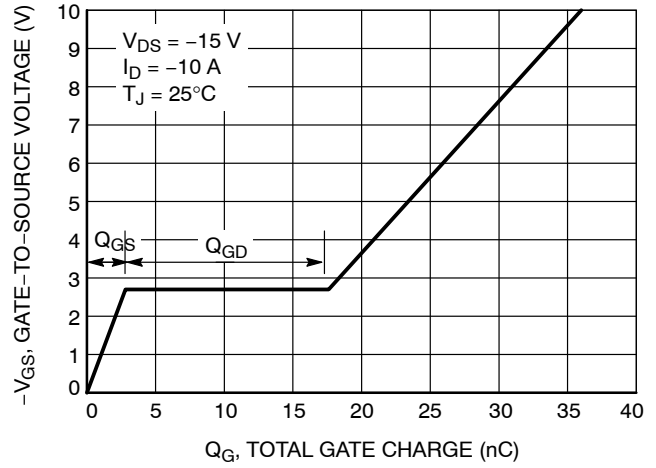

Figure 8. Gate-to-Source vs. Total Charge

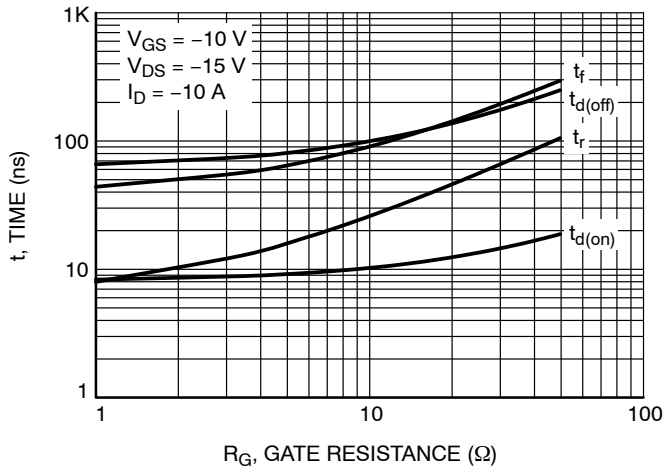

Figure 9. Resistive Switching Time Variation vs. Gate Resistance

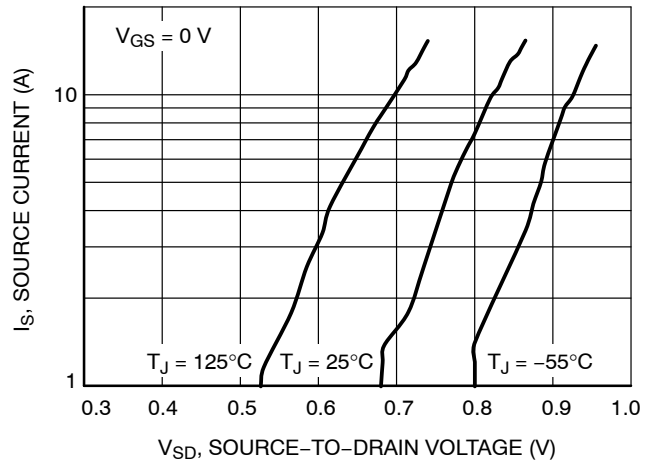

Figure 10. Diode Forward Voltage vs. Current

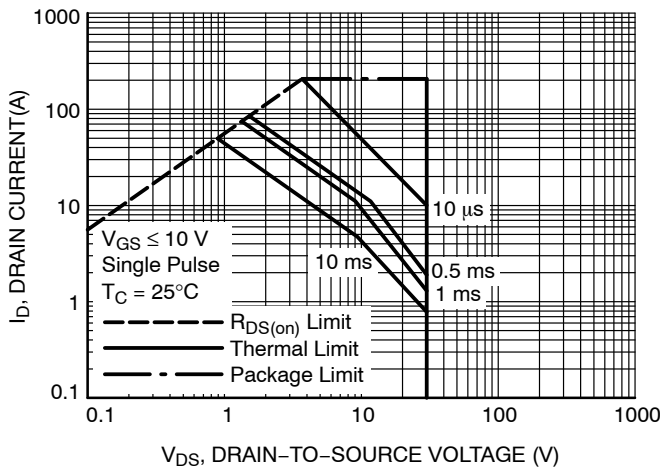

Figure 11. Maximum Rated Forward Biased Safe Operating Area

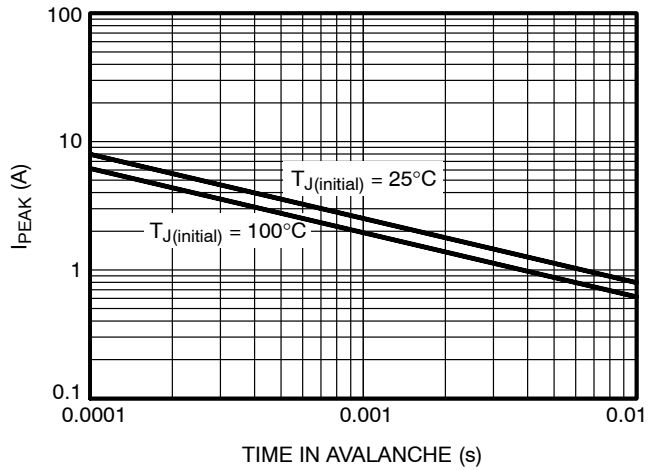

Figure 12. I_{PEAK} vs. Time in Avalanche

NVTFS012P03P8Z, NVTFWS012P03P8Z

TYPICAL CHARACTERISTICS

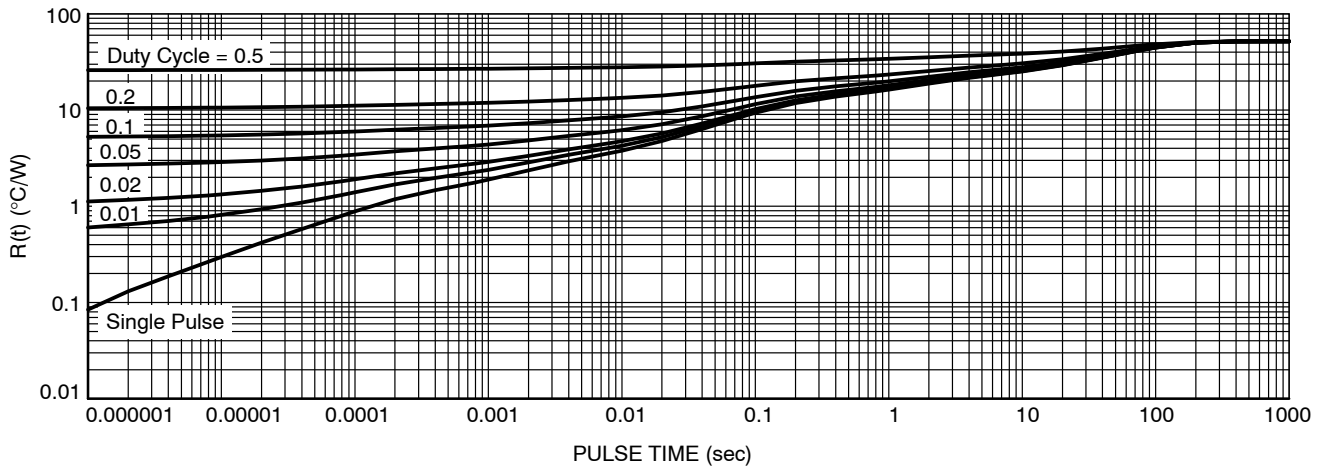

Figure 13. Thermal Characteristics

DEVICE ORDERING INFORMATION

Device	Device Marking	Package	Shipping [†]
NVTFS012P03P8ZTAG	12P3	WDFN8 (Pb-Free)	1500 / Tape & Reel
NVTFWS012P03P8ZTAG	12PW	WDFN8 (Pb-Free, Wettable Flank)	1500 / Tape & Reel

[†]For information on tape and reel specifications, including part orientation and tape sizes, please refer to our Tape and Reel Packaging Specifications Brochure, BRD8011/D.

NVTF5012P03P8Z, NVTFWS012P03P8Z

PACKAGE DIMENSIONS

WDFNW8 3.3x3.3, 0.65P (Full-Cut μ 8FL WF)
CASE 515AN
ISSUE O

NOTES:

1. DIMENSIONING AND TOLERANCING PER ASME Y14.5M, 2009.
2. CONTROLLING DIMENSION: MILLIMETERS
3. DIMENSION D1 AND E1 DO NOT INCLUDE MOLD FLASH, PROTRUSIONS, OR GATE BURRS.

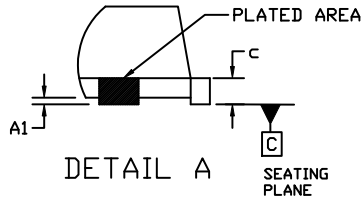
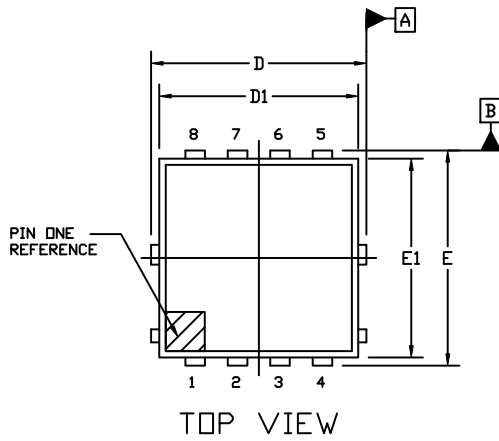

DIM	MILLIMETERS		
	MIN.	NDM.	MAX.
A	0.70	0.75	0.80
A1	0.00	----	0.05
b	0.23	0.30	0.40
c	0.15	0.20	0.25
D	3.05	3.30	3.55
D1	2.95	3.05	3.15
D2	1.98	2.11	2.24
E	3.05	3.30	3.55
E1	2.95	3.05	3.15
E2	1.47	1.60	1.73
E3	0.23	0.30	0.40
e	0.65 BSC		
G	0.30	0.41	0.51
K	0.65	0.80	0.95
L	0.30	0.43	0.59
L1	0.06	0.13	0.20
M	1.40	1.50	1.60

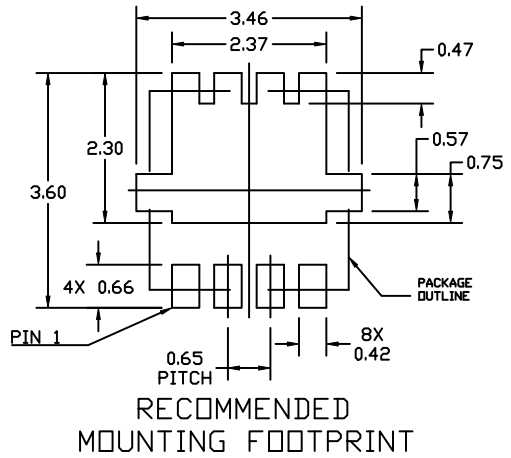
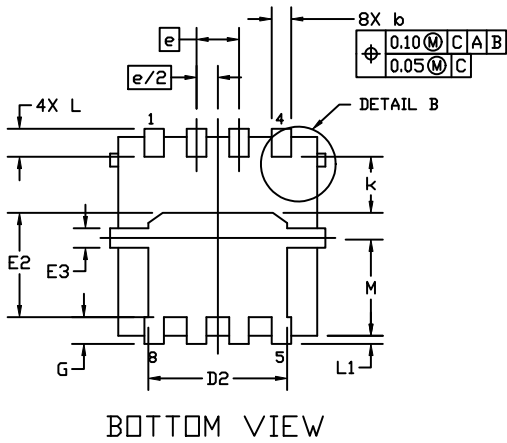
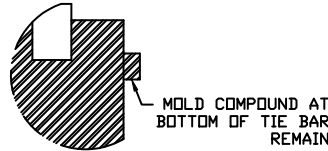
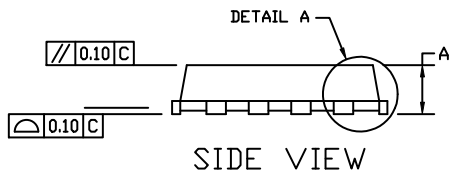

* For additional information on our Pb-Free strategy and soldering details, please download the ON Semiconductor Soldering and Mounting Techniques Reference Manual, SOLDERRM/D.

NVTF5012P03P8Z, NVTFWS012P03P8Z

PACKAGE DIMENSIONS

WDFN8 3.3x3.3, 0.65P
CASE 511AB
ISSUE D

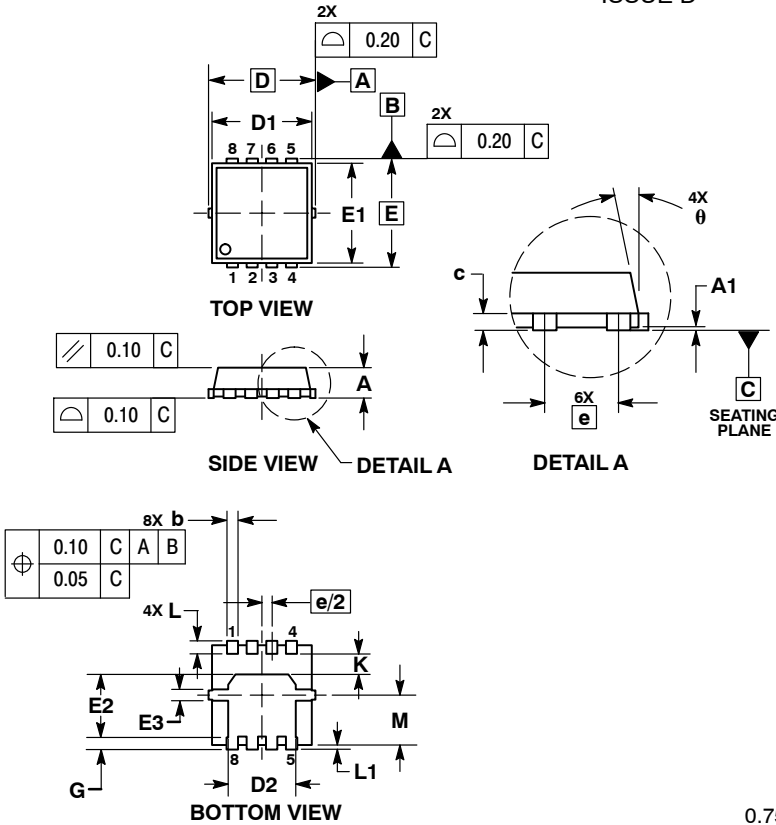

NOTES:

1. DIMENSIONING AND TOLERANCING PER ASME Y14.5M, 1994.
2. CONTROLLING DIMENSION: MILLIMETERS.
3. DIMENSION D1 AND E1 DO NOT INCLUDE MOLD FLASH PROTRUSIONS OR GATE BURRS.

DIM	MILLIMETERS			INCHES		
	MIN	NOM	MAX	MIN	NOM	MAX
A	0.70	0.75	0.80	0.028	0.030	0.031
A1	0.00	---	0.05	0.000	---	0.002
b	0.23	0.30	0.40	0.009	0.012	0.016
c	0.15	0.20	0.25	0.006	0.008	0.010
D	3.30 BSC			0.130 BSC		
D1	2.95	3.05	3.15	0.116	0.120	0.124
D2	1.98	2.11	2.24	0.078	0.083	0.088
E	3.30 BSC			0.130 BSC		
E1	2.95	3.05	3.15	0.116	0.120	0.124
E2	1.47	1.60	1.73	0.058	0.063	0.068
E3	0.23	0.30	0.40	0.009	0.012	0.016
e	0.65 BSC			0.026 BSC		
G	0.30	0.41	0.51	0.012	0.016	0.020
K	0.65	0.80	0.95	0.026	0.032	0.037
L	0.30	0.43	0.56	0.012	0.017	0.022
L1	0.06	0.13	0.20	0.002	0.005	0.008
M	1.40	1.50	1.60	0.055	0.059	0.063
θ	0 °	---	12 °	0 °	---	12 °

SOLDERING FOOTPRINT*

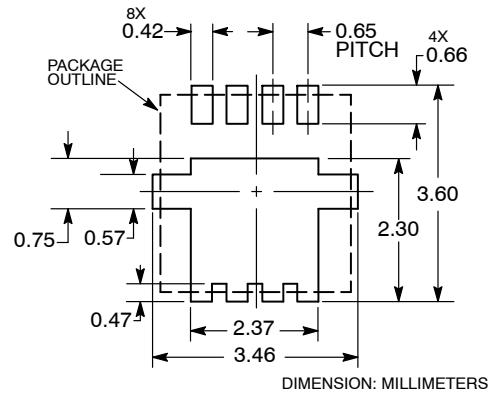

*For additional information on our Pb-Free strategy and soldering details, please download the **onsemi** Soldering and Mounting Techniques Reference Manual, SOLDERRM/D.

onsemi, **Onsemi**, and other names, marks, and brands are registered and/or common law trademarks of Semiconductor Components Industries, LLC dba "onsemi" or its affiliates and/or subsidiaries in the United States and/or other countries. onsemi owns the rights to a number of patents, trademarks, copyrights, trade secrets, and other intellectual property. A listing of onsemi's product/patent coverage may be accessed at www.onsemi.com/site/pdf/Patent-Marketing.pdf. onsemi reserves the right to make changes at any time to any products or information herein, without notice. The information herein is provided "as-is" and onsemi makes no warranty, representation or guarantee regarding the accuracy of the information, product features, availability, functionality, or suitability of its products for any particular purpose, nor does onsemi assume any liability arising out of the application or use of any product or circuit, and specifically disclaims any and all liability, including without limitation special, consequential or incidental damages. Buyer is responsible for its products and applications using onsemi products, including compliance with all laws, regulations and safety requirements or standards, regardless of any support or applications information provided by onsemi. "Typical" parameters which may be provided in onsemi data sheets and/or specifications can and do vary in different applications and actual performance may vary over time. All operating parameters, including "Typicals" must be validated for each customer application by customer's technical experts. onsemi does not convey any license under any of its intellectual property rights nor the rights of others. onsemi products are not designed, intended, or authorized for use as a critical component in life support systems or any FDA Class 3 medical devices or medical devices with a same or similar classification in a foreign jurisdiction or any devices intended for implantation in the human body. Should Buyer purchase or use onsemi products for any such unintended or unauthorized application, Buyer shall indemnify and hold onsemi and its officers, employees, subsidiaries, affiliates, and distributors harmless against all claims, costs, damages, and expenses, and reasonable attorney fees arising out of, directly or indirectly, any claim of personal injury or death associated with such unintended or unauthorized use, even if such claim alleges that onsemi was negligent regarding the design or manufacture of the part. onsemi is an Equal Opportunity/Affirmative Action Employer. This literature is subject to all applicable copyright laws and is not for resale in any manner.

ADDITIONAL INFORMATION

TECHNICAL PUBLICATIONS:

Technical Library: www.onsemi.com/design/resources/technical-documentation
onsemi Website: www.onsemi.com

ONLINE SUPPORT: www.onsemi.com/support

For additional information, please contact your local Sales Representative at www.onsemi.com/support/sales