

MOSFET - Power, DUAL COOL[®] N-Channel DFN8 5x6

60 V, 1.5 mΩ, 224 A

NVMFSC1D6N06CL

Features

- Advanced Dual-sided Cooled Packaging
- Ultra Low R_{DS(on)}
- MSL1 Robust Packaging Design
- AEC-Q101 Qualified

Typical Applications

- Orring FET/Load Switching
- Synchronous Rectifier
- DC-DC Conversion

MAXIMUM RATINGS (T_J = 25°C unless otherwise noted)

| Parameter | | Symbol | Value | Unit |
|--|---|-----------------------------------|----------------|---------|
| Drain-to-Source Voltage | | V _{DSS} | 60 | V |
| Gate-to-Source Voltage | | V _{GS} | ±20 | V |
| Continuous Drain Current R _{θJC} (Note 2) | Steady State | T _C = 25°C | I _D | 224 A |
| | | T _C = 100°C | I _D | 158.6 A |
| Power Dissipation R _{θJC} (Note 2) | Steady State | T _C = 25°C | P _D | 166 W |
| | | T _C = 100°C | P _D | 83 W |
| Continuous Drain Current R _{θJA} (Notes 1, 2) | Steady State | T _A = 25°C | I _D | 35 A |
| | | T _A = 100°C | I _D | 24.8 A |
| Power Dissipation R _{θJA} (Notes 1, 2) | Steady State | T _A = 25°C | P _D | 4.1 W |
| | | T _A = 100°C | P _D | 2 W |
| Pulsed Drain Current | T _A = 25°C, t _p = 10 μs | I _{DM} | 900 | A |
| Operating Junction and Storage Temperature Range | | T _J , T _{stg} | -55 to +175 | °C |
| Source Current (Body Diode) | | I _S | 164 | A |
| Single Pulse Drain-to-Source Avalanche Energy (I _{L(pk)} = 17 A) | | E _{AS} | 451 | mJ |
| Lead Temperature Soldering Reflow for Soldering Purposes (1/8" from case for 10 s) | | T _L | 300 | °C |

Stresses exceeding those listed in the Maximum Ratings table may damage the device. If any of these limits are exceeded, device functionality should not be assumed, damage may occur and reliability may be affected.

THERMAL RESISTANCE MAXIMUM RATINGS

| Parameter | Symbol | Value | Unit |
|---|------------------|-------|------|
| Junction-to-Case - Steady State (Note 2) | R _{θJC} | 0.9 | °C/W |
| Junction-to-Ambient - Steady State (Note 2) | R _{θJA} | 37 | |

1. Surface-mounted on FR4 board using a 1 in² pad size, 1 oz Cu pad.
2. The entire application environment impacts the thermal resistance values shown, they are not constants and are only valid for the particular conditions noted.

| V _{(BR)DSS} | R _{DS(ON) MAX} | I _{D MAX} |
|----------------------|-------------------------|--------------------|
| 60 V | 1.5 mΩ @ 10 V | 224 A |
| | 2.3 mΩ @ 4.5 V | |

N-Channel MOSFET

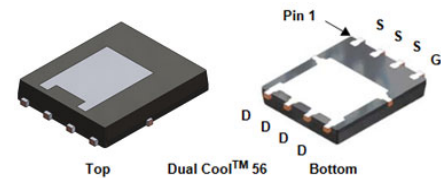
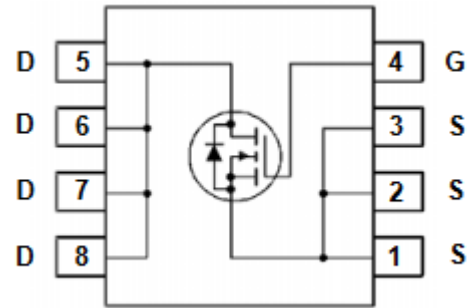

DFN8 (SO8FL)
CASES 506EG

MARKING DIAGRAM

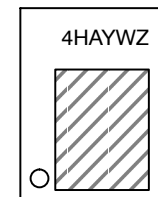

- 4H = Specific Device Code
- A = Assembly Location
- Y = Year
- W = Work Week
- Z = Assembly Lot Code

ORDERING INFORMATION

See detailed ordering, marking and shipping information on page 5 of this data sheet.

NVMFSC1D6N06CL

ELECTRICAL CHARACTERISTICS (T_J = 25°C unless otherwise specified)

| Parameter | Symbol | Test Condition | Min | Typ | Max | Unit |
|-----------|--------|----------------|-----|-----|-----|------|
|-----------|--------|----------------|-----|-----|-----|------|

OFF CHARACTERISTICS

| | | | | | | |
|---|--------------------------------------|--|------------------------|------|-----|-------|
| Drain-to-Source Breakdown Voltage | V _{(BR)DSS} | V _{GS} = 0 V, I _D = 250 μA | 60 | | | V |
| Drain-to-Source Breakdown Voltage Temperature Coefficient | V _{(BR)DSS} /T _J | I _D = 250 μA, ref to 25°C | | 12.7 | | mV/°C |
| Zero Gate Voltage Drain Current | I _{DSS} | V _{GS} = 0 V, V _{DS} = 60 V | T _J = 25°C | | 10 | μA |
| | | | T _J = 125°C | | 100 | |
| Gate-to-Source Leakage Current | I _{GSS} | V _{DS} = 0 V, V _{GS} = 20 V | | | 100 | nA |

ON CHARACTERISTICS (Note 3)

| | | | | | | |
|--|-------------------------------------|---|-----|------|-----|-------|
| Gate Threshold Voltage | V _{GS(TH)} | V _{GS} = V _{DS} , I _D = 250 μA | 1.2 | | 2.0 | V |
| Negative Threshold Temperature Coefficient | V _{GS(TH)} /T _J | I _D = 250 μA, ref to 25°C | | -5.8 | | mV/°C |
| Drain-to-Source On Resistance | R _{DS(on)} | V _{GS} = 10 V, I _D = 50 A | | 1.25 | 1.5 | mΩ |
| | | V _{GS} = 4.5 V, I _D = 50 A | | 1.65 | 2.3 | |
| Gate-Resistance | R _G | T _A = 25°C | | 2 | | Ω |

CHARGES & CAPACITANCES

| | | | | | | |
|------------------------------|---------------------|--|--|------|--|----|
| Input Capacitance | C _{ISS} | V _{GS} = 0 V, f = 1 MHz, V _{DS} = 25 V | | 6660 | | pF |
| Output Capacitance | C _{OSS} | | | 3000 | | |
| Reverse Transfer Capacitance | C _{RSS} | | | 45 | | |
| Total Gate Charge | Q _{G(TOT)} | V _{GS} = 4.5 V, V _{DS} = 30 V, I _D = 50 A | | 41 | | nC |
| Total Gate Charge | Q _{G(TOT)} | | | 91 | | |
| Gate-to-Source Charge | Q _{GS} | | | 17 | | |
| Gate-to-Drain Charge | Q _{GD} | | | 9 | | |
| Plateau Voltage | V _{GP} | | | 2.9 | | |

SWITCHING CHARACTERISTICS (Note 3)

| | | | | | | |
|---------------------|---------------------|--|--|------|--|----|
| Turn-On Delay Time | t _{d(ON)} | V _{GS} = 10 V, V _{DS} = 48 V, I _D = 50 A, R _G = 1 Ω | | 14.5 | | ns |
| Rise Time | t _r | | | 55.6 | | |
| Turn-Off Delay Time | t _{d(OFF)} | | | 47.5 | | |
| Fall Time | t _f | | | 14.1 | | |

DRAIN-SOURCE DIODE CHARACTERISTICS

| | | | | | | | |
|-------------------------|-----------------|---|------------------------|--|------|-----|----|
| Forward Diode Voltage | V _{SD} | V _{GS} = 0 V, I _S = 50 A | T _J = 25°C | | 0.78 | 1.2 | V |
| | | | T _J = 125°C | | 0.66 | | |
| Reverse Recovery Time | t _{RR} | V _{GS} = 0 V, di/dt = 100 A/μs, I _S = 50 A | | | 76 | | ns |
| Reverse Recovery Charge | Q _{RR} | | | | 130 | | nC |

Product parametric performance is indicated in the Electrical Characteristics for the listed test conditions, unless otherwise noted. Product performance may not be indicated by the Electrical Characteristics if operated under different conditions.

3. Switching characteristics are independent of operating junction temperatures.

TYPICAL CHARACTERISTICS

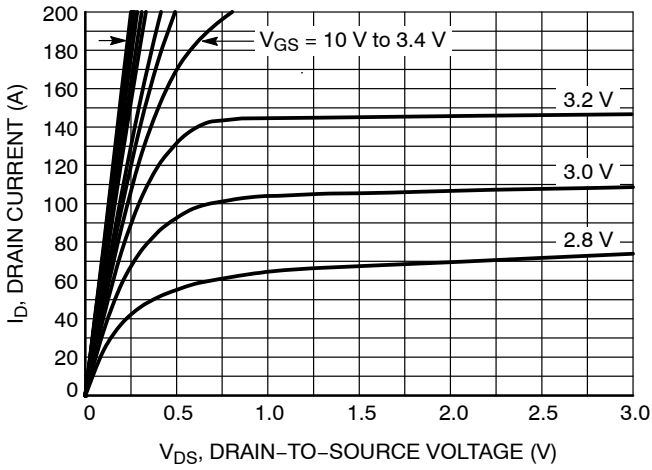

Figure 1. On-Region Characteristics

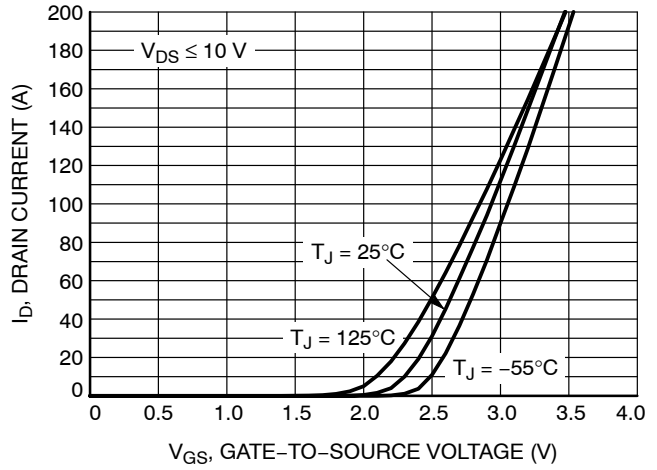

Figure 2. Transfer Characteristics

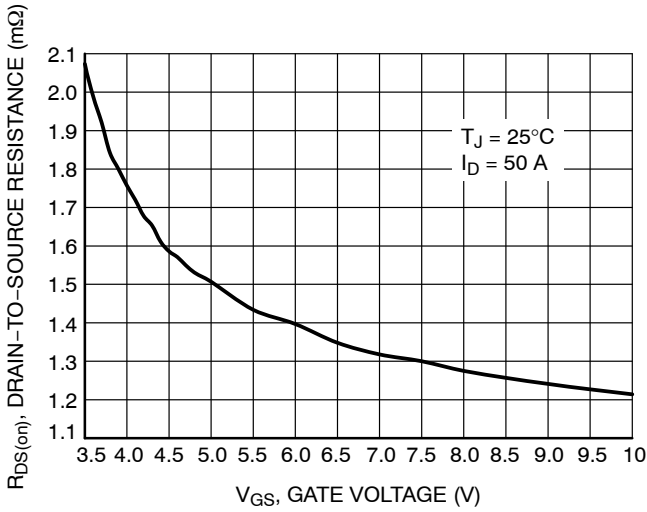

Figure 3. On-Resistance vs. Gate-to-Source Voltage

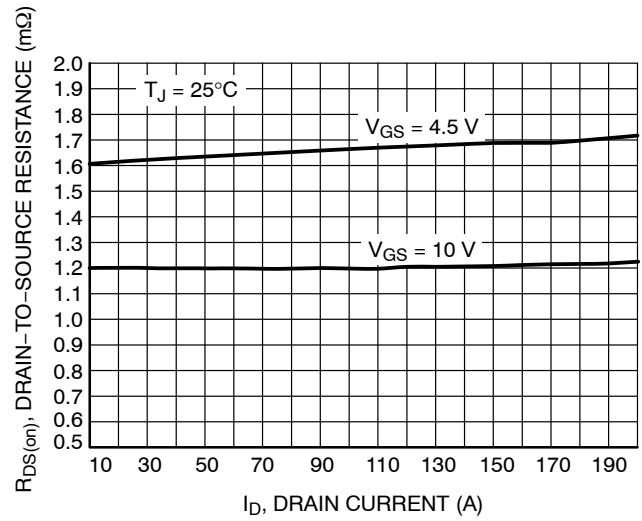

Figure 4. On-Resistance vs. Drain Current and Gate Voltage

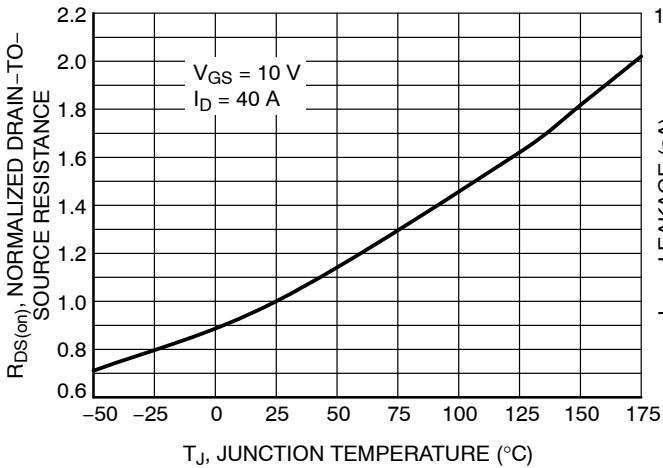

Figure 5. On-Resistance Variation with Temperature

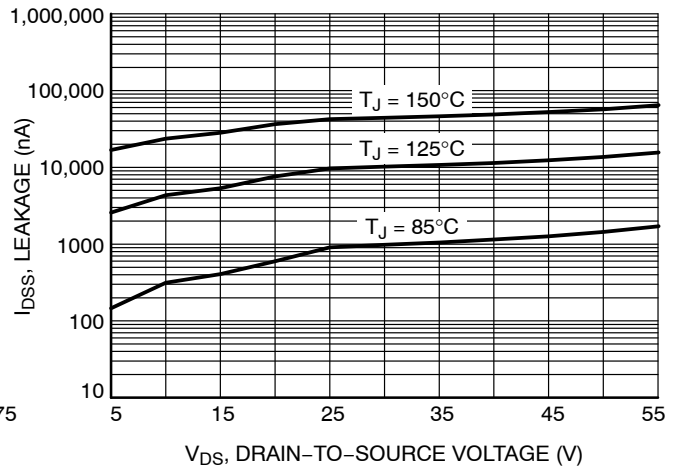

Figure 6. Drain-to-Source Leakage Current vs. Voltage

NVMFSC1D6N06CL

TYPICAL CHARACTERISTICS

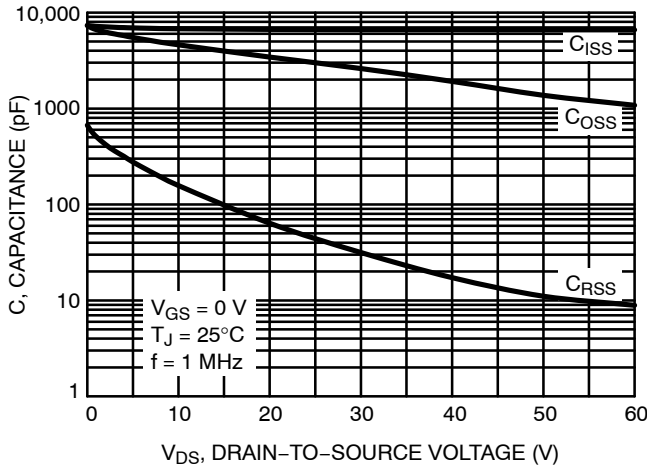

Figure 7. Capacitance Variation

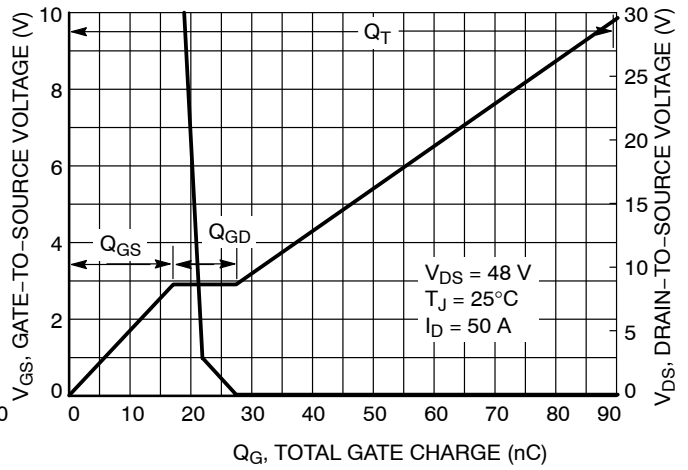

Figure 8. Gate-to-Source and Drain-to-Source Voltage vs. Total Charge

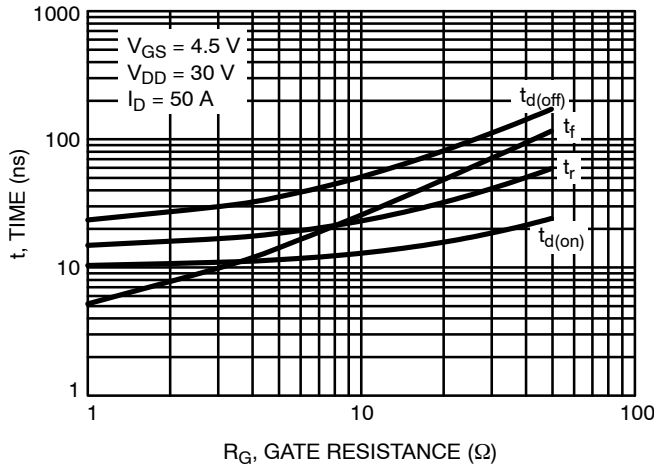

Figure 9. Resistive Switching Time Variation vs. Gate Resistance

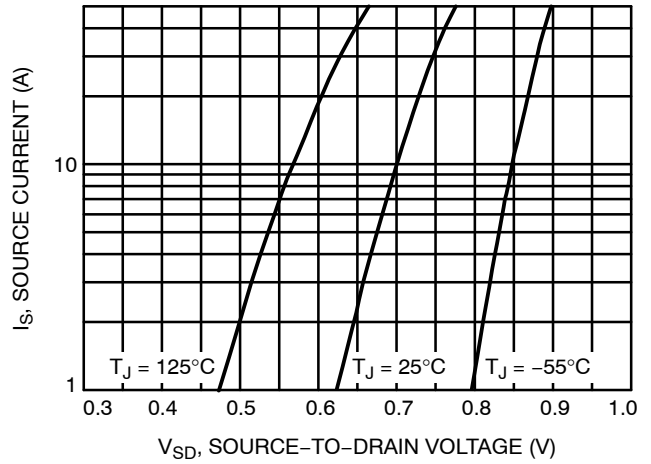

Figure 10. Diode Forward Voltage vs. Current

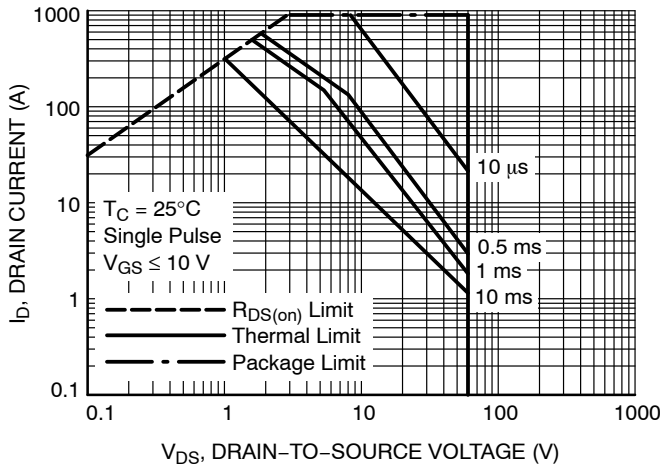

Figure 11. Safe Operating Area

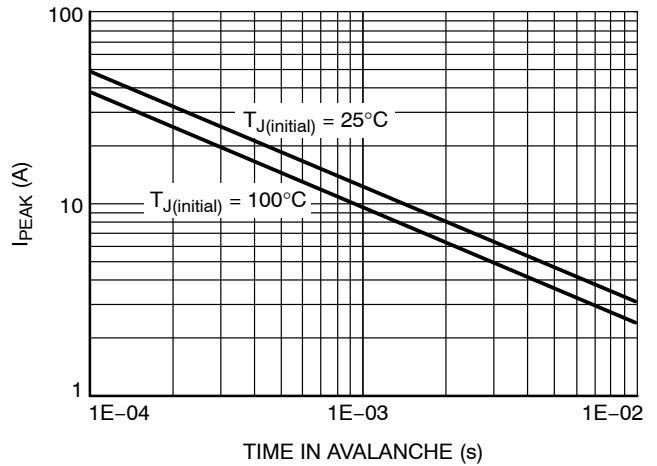

Figure 12. I_{PEAK} vs. Time in Avalanche

NVMFSC1D6N06CL

TYPICAL CHARACTERISTICS

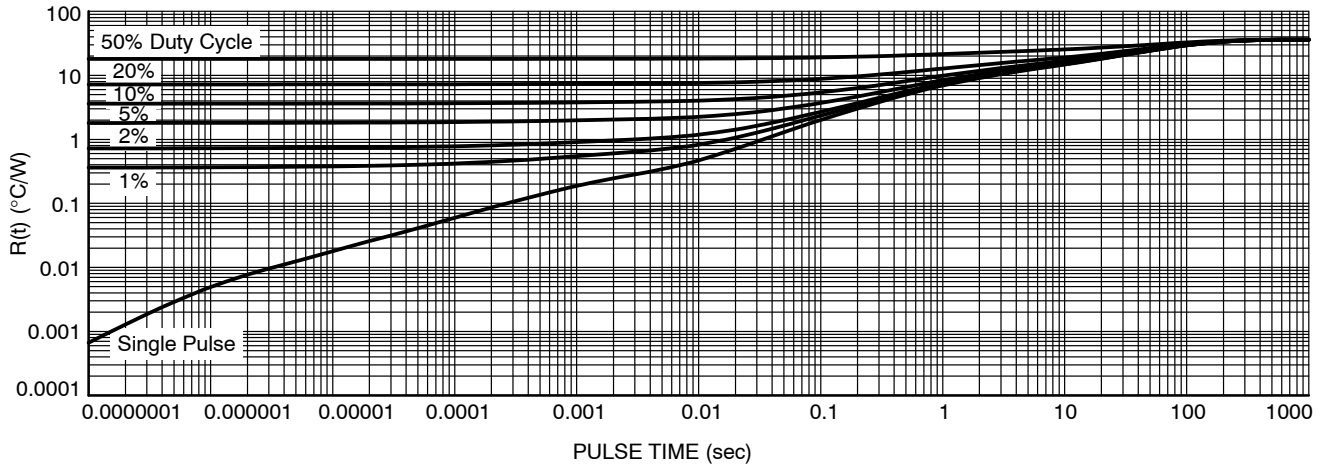

Figure 13. Thermal Characteristics

ORDERING INFORMATION

| Device | Device Marking | Package | Shipping [†] |
|----------------|----------------|------------------------------------|-----------------------|
| NVMFSC1D6N06CL | 4H | DFN8 5x6 (Pb-Free/Halogen Free) | 3000 / Tape & Reel |

[†]For information on tape and reel specifications, including part orientation and tape sizes, please refer to our Tape and Reel Packaging Specifications Brochure, BRD8011/D.

DUAL COOL is a registered trademark of Semiconductor Components Industries, LLC (SCILLC) or its subsidiaries in the United States and/or other countries.

MECHANICAL CASE OUTLINE

PACKAGE DIMENSIONS

ON Semiconductor®



DFN8 5x6.15, 1.27P, DUAL COOL CASE 506EG ISSUE D

DATE 25 AUG 2020

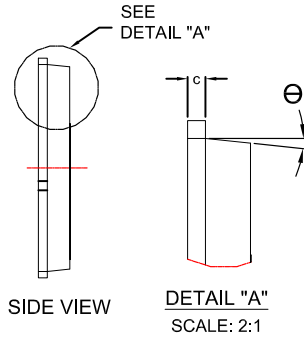
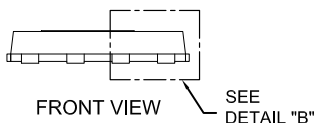
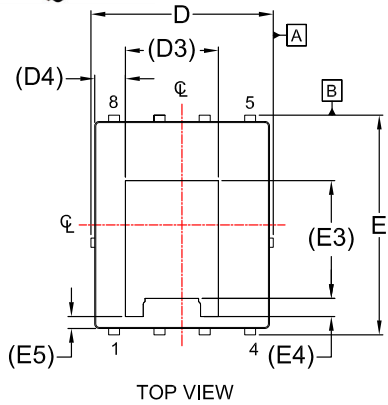
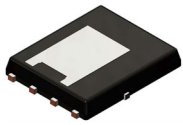

NOTES:

1. DIMENSIONING AND TOLERANCING PER ASME Y14.5M, 2009.
2. CONTROLLING DIMENSION: MILLIMETERS
3. COPLANARITY APPLIES TO THE EXPOSED PADS AS WELL AS THE TERMINALS.
4. DIMENSIONS D1 AND E1 DO NOT INCLUDE MOLD FLASH, PROTRUSIONS, OR GATE BURRS.
5. SEATING PLANE IS DEFINED BY THE TERMINALS. "A1" IS DEFINED AS THE DISTANCE FROM THE SEATING PLANE TO THE LOWEST POINT ON THE PACKAGE BODY.

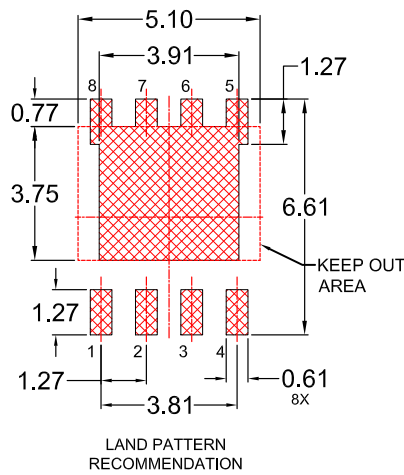
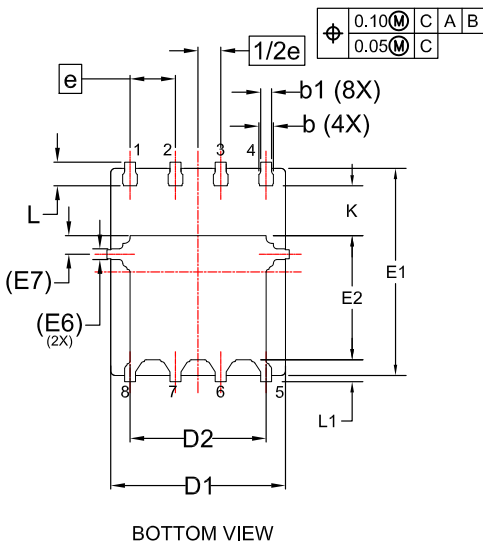
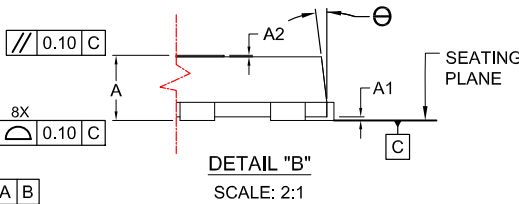

*FOR ADDITIONAL INFORMATION ON OUR PB-FREE STRATEGY AND SOLDERING DETAILS, PLEASE DOWNLOAD THE ON SEMICONDUCTOR SOLDERING AND MOUNTING TECHNIQUES REFERENCE MANUAL, SOLDERRM/D.

| DIM | MILLIMETERS | | |
|------|-------------|------|------|
| | MIN. | NOM. | MAX. |
| A | 0.85 | 0.90 | 0.95 |
| A1 | - | - | 0.05 |
| A2 | - | - | 0.05 |
| b | 0.31 | 0.41 | 0.51 |
| b1 | 0.21 | 0.31 | 0.41 |
| c | 0.20 | 0.25 | 0.30 |
| D | 4.90 | 5.00 | 5.10 |
| D1 | 4.80 | 4.90 | 5.00 |
| D2 | 3.67 | 3.82 | 3.97 |
| D3 | 2.60 REF | | |
| D4 | 0.86 REF | | |
| E | 6.05 | 6.15 | 6.25 |
| E1 | 5.70 | 5.80 | 5.90 |
| E2 | 3.38 | 3.48 | 3.58 |
| E3 | 3.30 REF | | |
| E4 | 0.50 REF | | |
| E5 | 0.34 REF | | |
| E6 | 0.30 REF | | |
| E7 | 0.52 REF | | |
| e | 1.27 BSC | | |
| 1/2e | 0.635 BSC | | |
| K | 1.30 | 1.40 | 1.50 |
| L | 0.56 | 0.66 | 0.76 |
| L1 | 0.52 | 0.62 | 0.72 |
| θ | 0° | --- | 12° |

GENERIC MARKING DIAGRAM*

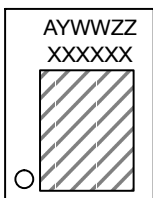

XXXX = Specific Device Code
 A = Assembly Location
 Y = Year
 WW = Work Week
 ZZ = Assembly Lot Code

*This information is generic. Please refer to device data sheet for actual part marking. Pb-Free indicator, "G" or microdot "•", may or may not be present. Some products may not follow the Generic Marking.

| | | |
|-------------------------|--------------------------------------|--|
| DOCUMENT NUMBER: | 98AON84257G | Electronic versions are uncontrolled except when accessed directly from the Document Repository. Printed versions are uncontrolled except when stamped "CONTROLLED COPY" in red. |
| DESCRIPTION: | DFN8 5x6.15, 1.27P, DUAL COOL | PAGE 1 OF 1 |

ON Semiconductor and ON are trademarks of Semiconductor Components Industries, LLC dba ON Semiconductor or its subsidiaries in the United States and/or other countries. ON Semiconductor reserves the right to make changes without further notice to any products herein. ON Semiconductor makes no warranty, representation or guarantee regarding the suitability of its products for any particular purpose, nor does ON Semiconductor assume any liability arising out of the application or use of any product or circuit, and specifically disclaims any and all liability, including without limitation special, consequential or incidental damages. ON Semiconductor does not convey any license under its patent rights nor the rights of others.

onsemi, **Onsemi**, and other names, marks, and brands are registered and/or common law trademarks of Semiconductor Components Industries, LLC dba "**onsemi**" or its affiliates and/or subsidiaries in the United States and/or other countries. **onsemi** owns the rights to a number of patents, trademarks, copyrights, trade secrets, and other intellectual property. A listing of **onsemi**'s product/patent coverage may be accessed at www.onsemi.com/site/pdf/Patent-Marking.pdf. **onsemi** reserves the right to make changes at any time to any products or information herein, without notice. The information herein is provided "as-is" and **onsemi** makes no warranty, representation or guarantee regarding the accuracy of the information, product features, availability, functionality, or suitability of its products for any particular purpose, nor does **onsemi** assume any liability arising out of the application or use of any product or circuit, and specifically disclaims any and all liability, including without limitation special, consequential or incidental damages. Buyer is responsible for its products and applications using **onsemi** products, including compliance with all laws, regulations and safety requirements or standards, regardless of any support or applications information provided by **onsemi**. "Typical" parameters which may be provided in **onsemi** data sheets and/or specifications can and do vary in different applications and actual performance may vary over time. All operating parameters, including "Typicals" must be validated for each customer application by customer's technical experts. **onsemi** does not convey any license under any of its intellectual property rights nor the rights of others. **onsemi** products are not designed, intended, or authorized for use as a critical component in life support systems or any FDA Class 3 medical devices or medical devices with a same or similar classification in a foreign jurisdiction or any devices intended for implantation in the human body. Should Buyer purchase or use **onsemi** products for any such unintended or unauthorized application, Buyer shall indemnify and hold **onsemi** and its officers, employees, subsidiaries, affiliates, and distributors harmless against all claims, costs, damages, and expenses, and reasonable attorney fees arising out of, directly or indirectly, any claim of personal injury or death associated with such unintended or unauthorized use, even if such claim alleges that **onsemi** was negligent regarding the design or manufacture of the part. **onsemi** is an Equal Opportunity/Affirmative Action Employer. This literature is subject to all applicable copyright laws and is not for resale in any manner.

PUBLICATION ORDERING INFORMATION

LITERATURE FULFILLMENT:

Email Requests to: orderlit@onsemi.com

onsemi Website: www.onsemi.com

TECHNICAL SUPPORT

North American Technical Support:

Voice Mail: 1 800-282-9855 Toll Free USA/Canada

Phone: 011 421 33 790 2910

Europe, Middle East and Africa Technical Support:

Phone: 00421 33 790 2910

For additional information, please contact your local Sales Representative