

# NUF2222FC

## 2 Line USB 1.1 Upstream EMI Filter

This device is a 2 line EMI filter array for USB port protection in wireless applications. Greater than -20 dB attenuation is obtained at frequencies from 900 MHz to 3.0 GHz. It also has 2 lines for dedicated ESD protection. ESD protection is provided across all capacitors.

### Features

- EMI Filtering and ESD Protection
- Integration of 10 Discretes
- Provides Protection for IEC61000-4-2 (Level 4)
  - ◆ 15 kV (Contact)
- Flip-Chip Package
- Moisture Sensitivity Level 1
- ESD Rating: Machine Model = C; Human Body Model = 3B

### Benefits

- Reduces EMI/RFI Emissions on a Data Line
- Integrated Solution Offers Cost and Space Savings
- Reduces Parasitic Inductances Which Offer a More “Ideal” Low Pass Filter Response
- Integrated Solution Improves System Reliability
- This is a Pb-Free Device

### Applications

- EMI Filtering and ESD Protection for Data Lines
- Cell Phones
- Handheld Products
- Notebook Computers
- MP3 Players

### MAXIMUM RATINGS (T<sub>A</sub> = 25°C unless otherwise noted)

Rating		Symbol	Value	Unit
ESD Discharge IEC61000-4-2	Contact Discharge	V <sub>PP</sub>	15	kV
Operating Temperature Range		T <sub>OP</sub>	-40 to +85	°C
Storage Temperature Range		T <sub>STG</sub>	-55 to +150	°C
Junction Temperature		T <sub>J</sub>	+125	°C

Maximum ratings are those values beyond which device damage can occur. Maximum ratings applied to the device are individual stress limit values (not normal operating conditions) and are not valid simultaneously. If these limits are exceeded, device functional operation is not implied, damage may occur and reliability may be affected.

\*For additional information on our Pb-Free strategy and soldering details, please download the ON Semiconductor Soldering and Mounting Techniques Reference Manual, SOLDERRM/D.



**ON Semiconductor®**

<http://onsemi.com>

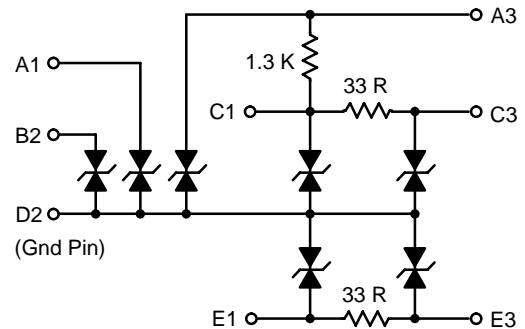

Flip-Chip  
FC SUFFIX  
CASE 499AM

### MARKING DIAGRAM



2222 = Specific Device Code  
A = Assembly Location  
Y = Year  
WW = Work Week

### PIN CONFIGURATION

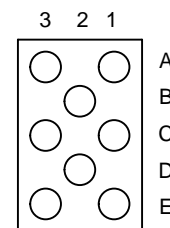

### ORDERING INFORMATION

Device	Package	Shipping†
NUF2222FCT1G	Flip-Chip	3000 Tape & Reel

†For information on tape and reel specifications, including part orientation and tape sizes, please refer to our Tape and Reel Packaging Specifications Brochure, BRD8011/D.

# NUF2222FC

## ELECTRICAL CHARACTERISTICS (T<sub>A</sub> = 25°C unless otherwise noted)

Characteristic	Symbol	Test Conditions	Min	Typ	Max	Unit
Maximum Reverse Working Voltage	V <sub>RWM</sub>	–	–	–	5.6	V
Breakdown Voltage	V <sub>BR</sub>	I <sub>R</sub> = 1.0 mA	6.0	–	8.8	V
Leakage Current	I <sub>R</sub>	V <sub>RWM</sub> = 3.3 V	–	1.0	100	nA
Pull Up Resistance	R <sub>pu</sub>	–	1.1	1.3	1.5	kΩ
Series Resistance	R <sub>S</sub>	–	28	33	38	Ω
Capacitance	C <sub>LINE</sub>	f = 1.0 MHz, 0 Vdc	–	36	40	pF
Cut-Off Frequency	f <sub>3dB</sub>	50 Ω Source and 50 Ω Load Termination	–	190	–	MHz

# NUF2222FC

## TYPICAL PERFORMANCE CURVES

( $T_A = 25^\circ\text{C}$  unless otherwise specified)

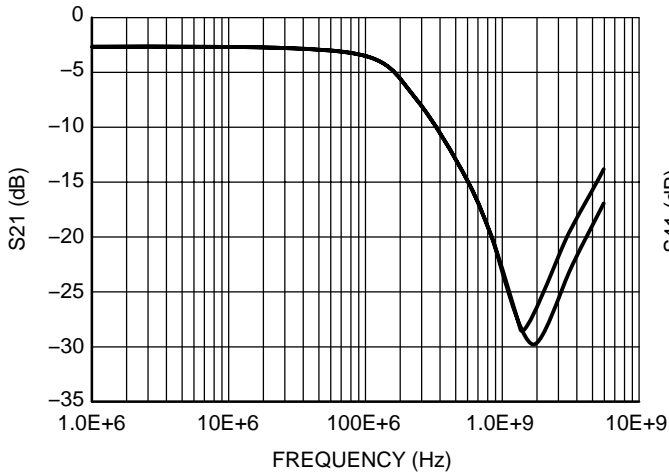

**Figure 1. Typical Insertion Loss Characteristics**

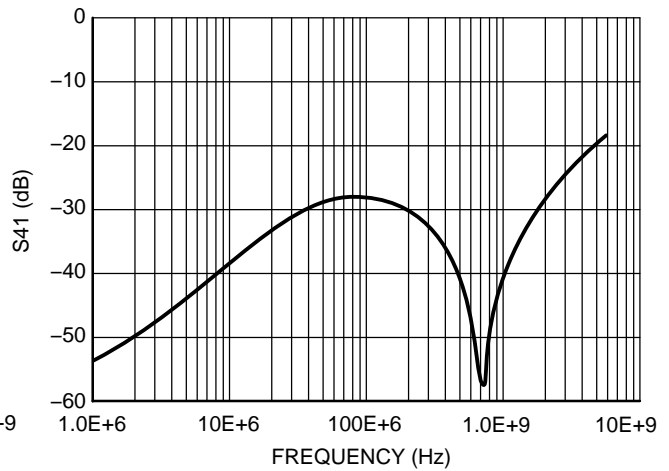

**Figure 2. Typical Crosstalk Characteristics**

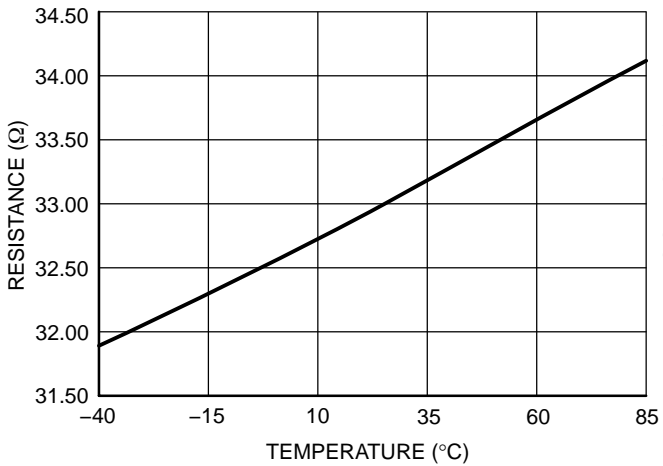

**Figure 3. Typical Resistance (R33) vs. Temperature**

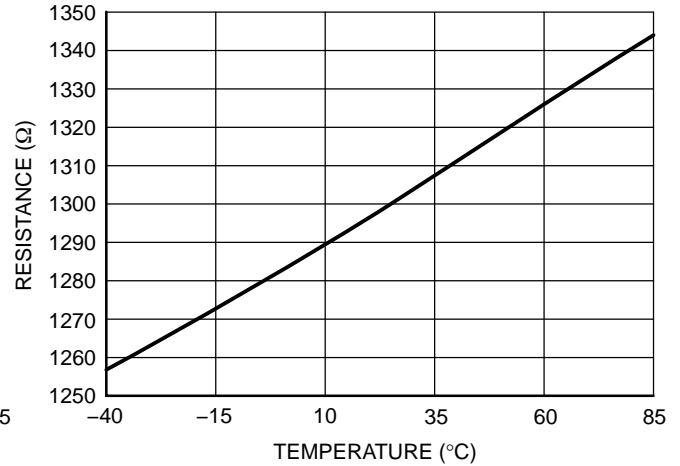

**Figure 4. Typical Resistance (R1300) vs. Temperature**

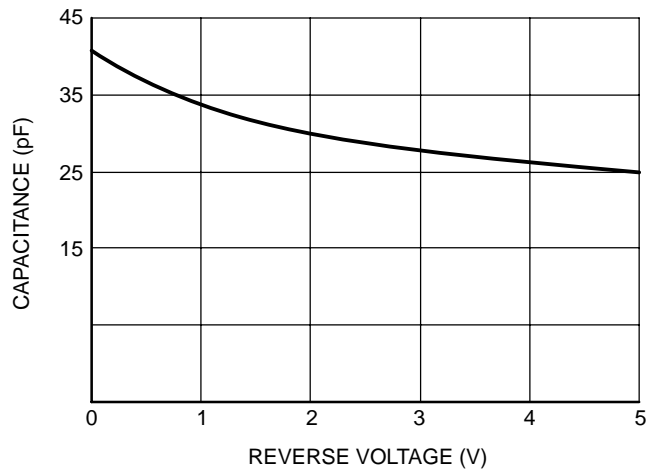

**Figure 5. Typical Line Capacitance vs. Reverse Bias Voltage**

PRINTED CIRCUIT BOARD RECOMMENDATIONS

Parameter	500 $\mu\text{m}$ Pitch 300 or 350 $\mu\text{m}$ Solder Ball
PCB Pad Size	250 $\mu\text{m}$ +25 -0
Pad Shape	Round
Pad Type	NSMD
Solder Mask Opening	350 $\mu\text{m}$ $\pm$ 25
Solder Stencil Thickness	125 $\mu\text{m}$
Stencil Aperture	250 x 250 $\mu\text{m}$ sq.
Solder Flux Ratio	50/50
Solder Paste Type	No Clean Type 3 or Finer
Trace Finish	OSP Cu
Trace Width	150 $\mu\text{m}$ Max

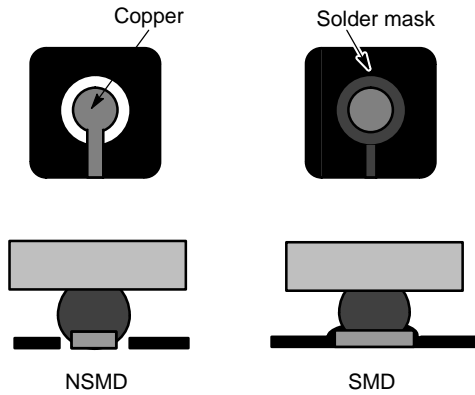

Figure 6. NSMD vs. SMD

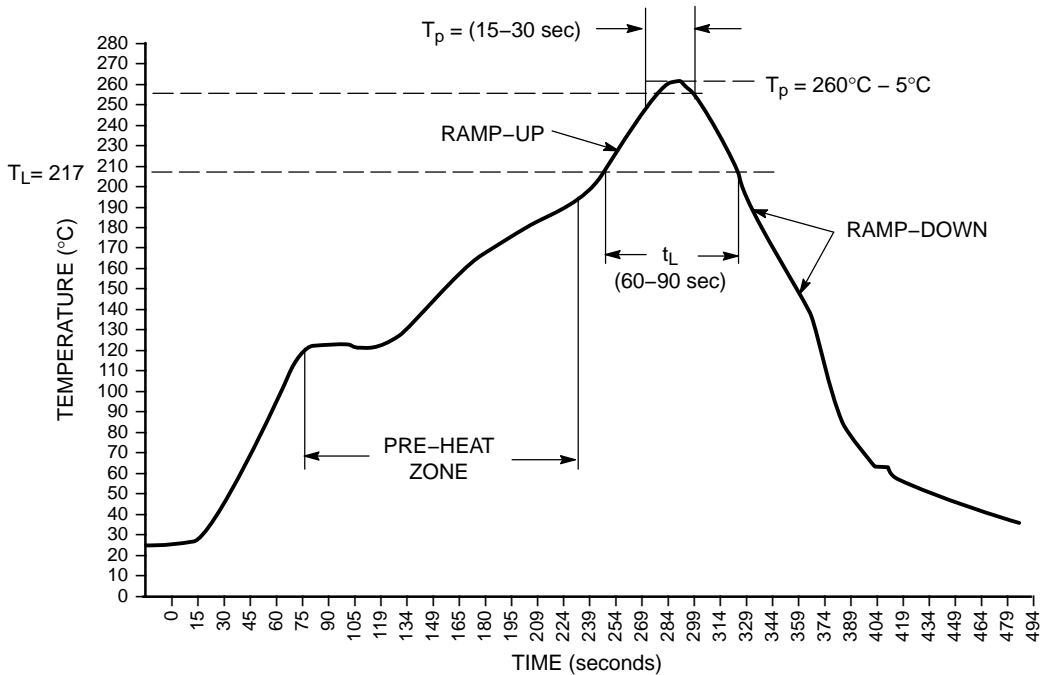

Figure 7. Typical Pb-Free Solder Heating Profile

# MECHANICAL CASE OUTLINE

## PACKAGE DIMENSIONS

ON Semiconductor®



### 8 PIN FLIP-CHIP CASE 499AM-01 ISSUE 0

DATE 17 FEB 2005



SCALE 4:1

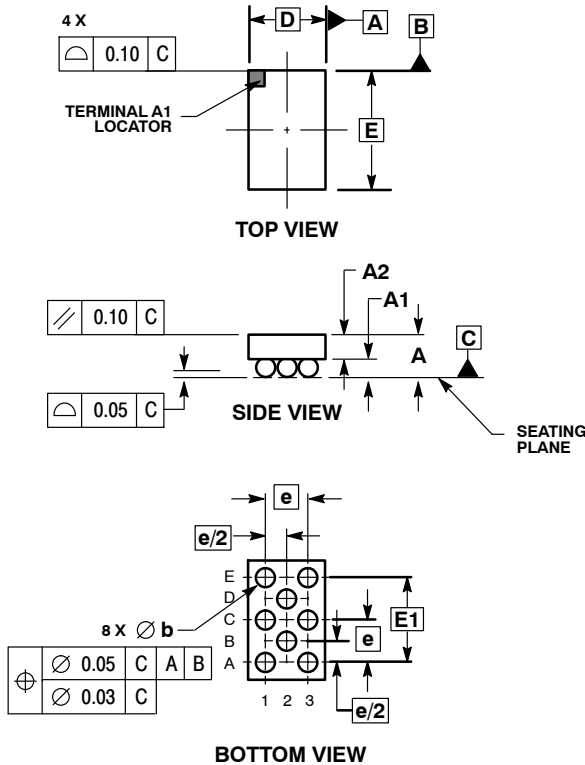

NOTES:

1. DIMENSIONING AND TOLERANCING PER ASME Y14.5M, 1994.
2. CONTROLLING DIMENSION: MILLIMETER.
3. COPLANARITY APPLIES TO SPHERICAL CROWNS OF SOLDER BALLS.

DIM	MILLIMETERS	
	MIN	MAX
A	---	0.700
A1	0.210	0.270
A2	0.380	0.430
D	1.270 BSC	
E	1.970 BSC	
b	0.290	0.340
e	0.700 BSC	
E1	1.400 BSC	

### GENERIC MARKING DIAGRAM\*

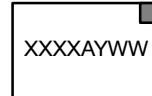

- XXXX = Specific Device Code
- A = Assembly Location
- Y = Year
- WW = Work Week
- G or ■ = Pb-Free Package

\*This information is generic. Please refer to device data sheet for actual part marking.  
Pb-Free indicator, "G" or microdot "■", may or may not be present.

<b>DOCUMENT NUMBER:</b>	<b>98AON20414D</b>	Electronic versions are uncontrolled except when accessed directly from the Document Repository. Printed versions are uncontrolled except when stamped "CONTROLLED COPY" in red.
<b>DESCRIPTION:</b>	<b>8 PIN FLIP-CHIP, 1.970*1.270,, 0.700 LEAD PITCH</b>	<b>PAGE 1 OF 1</b>

ON Semiconductor and are trademarks of Semiconductor Components Industries, LLC dba ON Semiconductor or its subsidiaries in the United States and/or other countries. ON Semiconductor reserves the right to make changes without further notice to any products herein. ON Semiconductor makes no warranty, representation or guarantee regarding the suitability of its products for any particular purpose, nor does ON Semiconductor assume any liability arising out of the application or use of any product or circuit, and specifically disclaims any and all liability, including without limitation special, consequential or incidental damages. ON Semiconductor does not convey any license under its patent rights nor the rights of others.

**onsemi**, **Onsemi**, and other names, marks, and brands are registered and/or common law trademarks of Semiconductor Components Industries, LLC dba "**onsemi**" or its affiliates and/or subsidiaries in the United States and/or other countries. **onsemi** owns the rights to a number of patents, trademarks, copyrights, trade secrets, and other intellectual property. A listing of **onsemi**'s product/patent coverage may be accessed at [www.onsemi.com/site/pdf/Patent-Marking.pdf](http://www.onsemi.com/site/pdf/Patent-Marking.pdf). **onsemi** reserves the right to make changes at any time to any products or information herein, without notice. The information herein is provided "as-is" and **onsemi** makes no warranty, representation or guarantee regarding the accuracy of the information, product features, availability, functionality, or suitability of its products for any particular purpose, nor does **onsemi** assume any liability arising out of the application or use of any product or circuit, and specifically disclaims any and all liability, including without limitation special, consequential or incidental damages. Buyer is responsible for its products and applications using **onsemi** products, including compliance with all laws, regulations and safety requirements or standards, regardless of any support or applications information provided by **onsemi**. "Typical" parameters which may be provided in **onsemi** data sheets and/or specifications can and do vary in different applications and actual performance may vary over time. All operating parameters, including "Typicals" must be validated for each customer application by customer's technical experts. **onsemi** does not convey any license under any of its intellectual property rights nor the rights of others. **onsemi** products are not designed, intended, or authorized for use as a critical component in life support systems or any FDA Class 3 medical devices or medical devices with a same or similar classification in a foreign jurisdiction or any devices intended for implantation in the human body. Should Buyer purchase or use **onsemi** products for any such unintended or unauthorized application, Buyer shall indemnify and hold **onsemi** and its officers, employees, subsidiaries, affiliates, and distributors harmless against all claims, costs, damages, and expenses, and reasonable attorney fees arising out of, directly or indirectly, any claim of personal injury or death associated with such unintended or unauthorized use, even if such claim alleges that **onsemi** was negligent regarding the design or manufacture of the part. **onsemi** is an Equal Opportunity/Affirmative Action Employer. This literature is subject to all applicable copyright laws and is not for resale in any manner.

## PUBLICATION ORDERING INFORMATION

### LITERATURE FULFILLMENT:

Email Requests to: [orderlit@onsemi.com](mailto:orderlit@onsemi.com)

**onsemi Website:** [www.onsemi.com](http://www.onsemi.com)

### TECHNICAL SUPPORT

**North American Technical Support:**

Voice Mail: 1 800-282-9855 Toll Free USA/Canada

Phone: 011 421 33 790 2910

**Europe, Middle East and Africa Technical Support:**

Phone: 00421 33 790 2910

For additional information, please contact your local Sales Representative