

# NTNS3A65PZ

## MOSFET – Single, P-Channel, Small Signal, SOT-883 (XDFN3), 1.0 x 0.6 x 0.4 mm -20 V, -281 mA

### Features

- Single P-Channel MOSFET
- Ultra Low Profile SOT-883 (XDFN3) 1.0 x 0.6 x 0.4 mm for Extremely Thin Environments Such as Portable Electronics
- Low  $R_{DS(on)}$  Solution in the Ultra Small 1.0 x 0.6 mm Package
- 1.5 V Gate Drive
- These Devices are Pb-Free, Halogen Free/BFR Free and are RoHS Compliant

### Applications

- High Side Switch
- High Speed Interfacing
- Optimized for Power Management in Ultra Portable Solutions

### MAXIMUM RATINGS ( $T_J = 25^\circ\text{C}$ unless otherwise stated)

| Parameter   |                        | Symbol                   | Value                    | Unit                 |    |
|---|------------------------|--------------------------|--------------------------|----------------------|----|
| Drain-to-Source Voltage   |                        | $V_{DS}$                 | -20                      | V                    |    |
| Gate-to-Source Voltage  |                        | $V_{GS}$                 | $\pm 8$                  | V                    |    |
| Continuous Drain Current (Note 1)                                 | Steady State           | $I_D$                    | $T_A = 25^\circ\text{C}$ | -281                 | mA |
|   |                        |                          | $T_A = 85^\circ\text{C}$ | -202                 |    |
|   | $t \leq 5 \text{ s}$   | $T_A = 25^\circ\text{C}$ | -332                     |                      |    |
| Power Dissipation (Note 1)  | Steady State           | $P_D$                    | $T_A = 25^\circ\text{C}$ |                      | mW |
|   |                        |                          |                          | $t \leq 5 \text{ s}$ |    |
| Pulsed Drain Current  | $t_p = 10 \mu\text{s}$ | $I_{DM}$                 | -842                     | mA                   |    |
| Operating Junction and Storage Temperature                        |                        | $T_J, T_{STG}$           | -55 to 150               | $^\circ\text{C}$     |    |
| Source Current (Body Diode) (Note 2)                              |                        | $I_S$                    | -130                     | mA                   |    |
| Lead Temperature for Soldering Purposes (1/8" from case for 10 s) |                        | $T_L$                    | 260                      | $^\circ\text{C}$     |    |

Stresses exceeding Maximum Ratings may damage the device. Maximum Ratings are stress ratings only. Functional operation above the Recommended Operating Conditions is not implied. Extended exposure to stresses above the Recommended Operating Conditions may affect device reliability.

1. Surface-mounted on FR4 board using the minimum recommended pad size, or 2 mm<sup>2</sup>, 1 oz Cu.
2. Pulse Test: pulse width  $\leq 300 \mu\text{s}$ , duty cycle  $\leq 2\%$



ON Semiconductor®

<http://onsemi.com>

| $V_{(BR)DSS}$ | $R_{DS(on)}$ MAX      | $I_D$ Max |
|---------------|-----------------------|-----------|
| -20 V         | 1.3 $\Omega$ @ -4.5 V | -281 mA   |
|               | 2.0 $\Omega$ @ -2.5 V |           |
|               | 3.4 $\Omega$ @ -1.8 V |           |
|               | 4.5 $\Omega$ @ -1.5 V |           |

### P-CHANNEL MOSFET

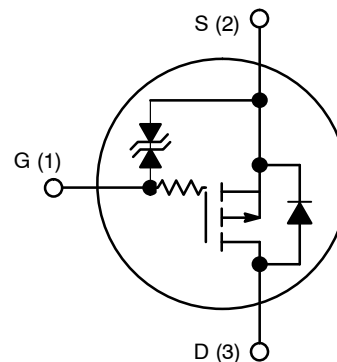

SOT-883 (XDFN3)  
CASE 506CB

### MARKING DIAGRAM

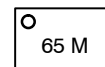

65 = Specific Device Code  
M = Date Code

### ORDERING INFORMATION

| Device        | Package           | Shipping†          |
|---------------|-------------------|--------------------|
| NTNS3A65PZT5G | SOT-883 (Pb-Free) | 8000 / Tape & Reel |

†For information on tape and reel specifications, including part orientation and tape sizes, please refer to our Tape and Reel Packaging Specification Brochure, BRD8011/D.

# NTNS3A65PZ

## THERMAL RESISTANCE RATINGS

| Parameter                                   | Symbol          | Max | Unit |
|---|-----------------|-----|------|
| Junction-to-Ambient – Steady State (Note 3) | $R_{\theta JA}$ | 804 | °C/W |
| Junction-to-Ambient – $t \leq 5$ s (Note 3) | $R_{\theta JA}$ | 574 |      |

3. Surface-mounted on FR4 board using the minimum recommended pad size, or 2 mm<sup>2</sup>, 1 oz Cu.

## ELECTRICAL CHARACTERISTICS ( $T_J = 25^\circ\text{C}$ unless otherwise stated)

| Parameter | Symbol | Test Condition | Min | Typ | Max | Unit |
|-----------|--------|----------------|-----|-----|-----|------|
|-----------|--------|----------------|-----|-----|-----|------|

### OFF CHARACTERISTICS

|   |                   |  |     |    |          |         |
|---|-------------------|--|-----|----|----------|---------|
| Drain-to-Source Breakdown Voltage                         | $V_{(BR)DSS}$     | $V_{GS} = 0$ V, $I_D = -250$ $\mu$ A                       | -20 |    |          | V       |
| Drain-to-Source Breakdown Voltage Temperature Coefficient | $V_{(BR)DSS}/T_J$ | $I_D = -250$ $\mu$ A, ref to 25°C                          |     | 11 |          | mV/°C   |
| Zero Gate Voltage Drain Current                           | $I_{DSS}$         | $V_{GS} = 0$ V, $V_{DS} = -20$ V, $T_J = 25^\circ\text{C}$ |     |    | -1       | $\mu$ A |
| Gate-to-Source Leakage Current                            | $I_{GSS}$         | $V_{DS} = 0$ V, $V_{GS} = \pm 5$ V                         |     |    | $\pm 10$ | $\mu$ A |

### ON CHARACTERISTICS (Note 4)

|  |                  |  |      |      |      |          |
|--|------------------|--|------|------|------|----------|
| Gate Threshold Voltage                     | $V_{GS(TH)}$     | $V_{GS} = V_{DS}$ , $I_D = -250$ $\mu$ A | -0.4 |      | -1.0 | V        |
| Negative Threshold Temperature Coefficient | $V_{GS(TH)}/T_J$ |  |      | 2.2  |      | mV/°C    |
| Drain-to-Source On Resistance              | $R_{DS(on)}$     | $V_{GS} = -4.5$ V, $I_D = -200$ mA       |      | 0.9  | 1.3  | $\Omega$ |
|  |                  | $V_{GS} = -2.5$ V, $I_D = -100$ mA       |      | 1.3  | 2.0  |          |
|  |                  | $V_{GS} = -1.8$ V, $I_D = -50$ mA        |      | 1.8  | 3.4  |          |
|  |                  | $V_{GS} = -1.5$ V, $I_D = -10$ mA        |      | 2.3  | 4.5  | $\Omega$ |
| Forward Transconductance                   | $g_{FS}$         | $V_{DS} = -5$ V, $I_D = -200$ mA         |      | 0.58 |      | S        |
| Source-Drain Diode Voltage                 | $V_{SD}$         | $V_{GS} = 0$ V, $I_S = -100$ mA          |      | -0.8 | -1.2 | V        |

### CHARGES & CAPACITANCES

|                              |              |   |  |     |  |    |
|------------------------------|--------------|---|--|-----|--|----|
| Input Capacitance            | $C_{ISS}$    | $V_{GS} = 0$ V, freq = 1 MHz, $V_{DS} = -10$ V          |  | 44  |  | pF |
| Output Capacitance           | $C_{OSS}$    |   |  | 6.7 |  |    |
| Reverse Transfer Capacitance | $C_{RSS}$    |   |  | 5.5 |  |    |
| Total Gate Charge            | $Q_{G(TOT)}$ | $V_{GS} = -4.5$ V, $V_{DS} = -10$ V;<br>$I_D = -200$ mA |  | 1.1 |  | nC |
| Threshold Gate Charge        | $Q_{G(TH)}$  |   |  | 0.1 |  |    |
| Gate-to-Source Charge        | $Q_{GS}$     |   |  | 0.2 |  |    |
| Gate-to-Drain Charge         | $Q_{GD}$     |   |  | 0.2 |  |    |

### SWITCHING CHARACTERISTICS, $V_{GS} = 4.5$ V (Note 4)

|                     |              |   |  |     |  |    |
|---------------------|--------------|---|--|-----|--|----|
| Turn-On Delay Time  | $t_{d(ON)}$  | $V_{GS} = -4.5$ V, $V_{DD} = -10$ V,<br>$I_D = -200$ mA, $R_G = 2$ $\Omega$ |  | 18  |  | ns |
| Rise Time           | $t_r$        |   |  | 32  |  |    |
| Turn-Off Delay Time | $t_{d(OFF)}$ |   |  | 178 |  |    |
| Fall Time           | $t_f$        |   |  | 84  |  |    |

4. Switching characteristics are independent of operating junction temperatures

# NTNS3A65PZ

## TYPICAL CHARACTERISTICS

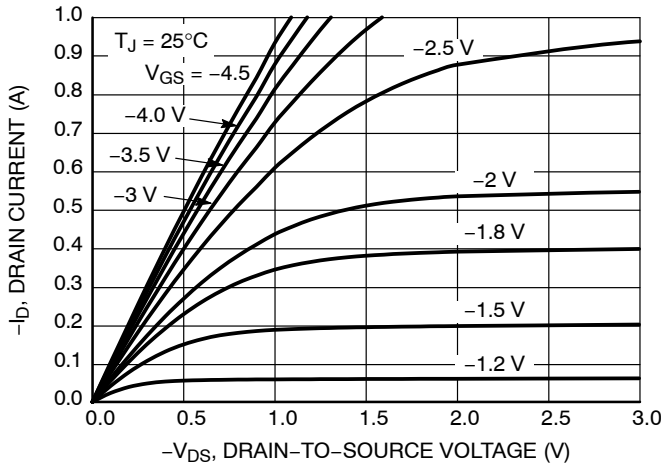

Figure 1. On-Region Characteristics

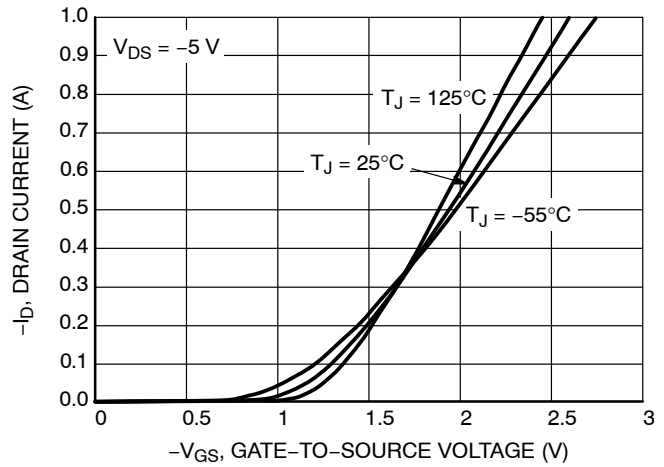

Figure 2. Transfer Characteristics

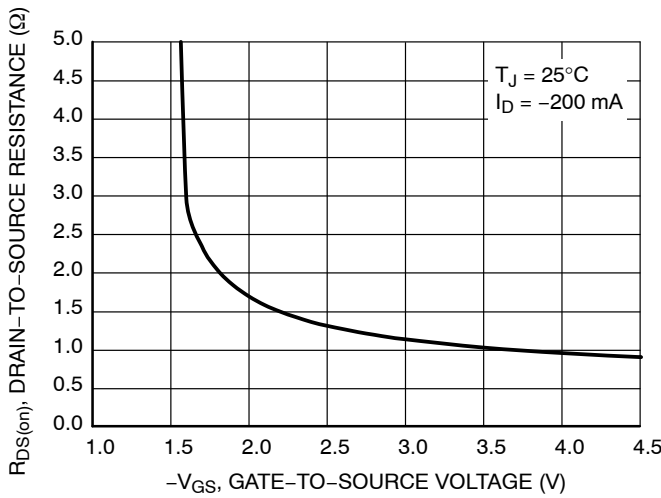

Figure 3. On-Resistance vs. Gate Voltage

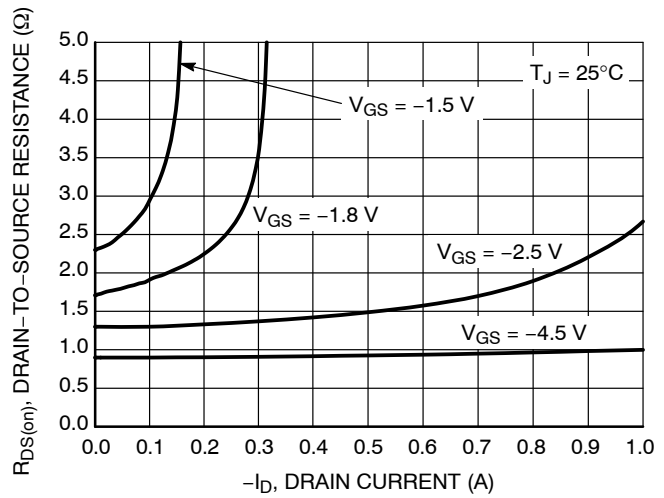

Figure 4. On-Resistance vs. Drain Current and Gate Voltage

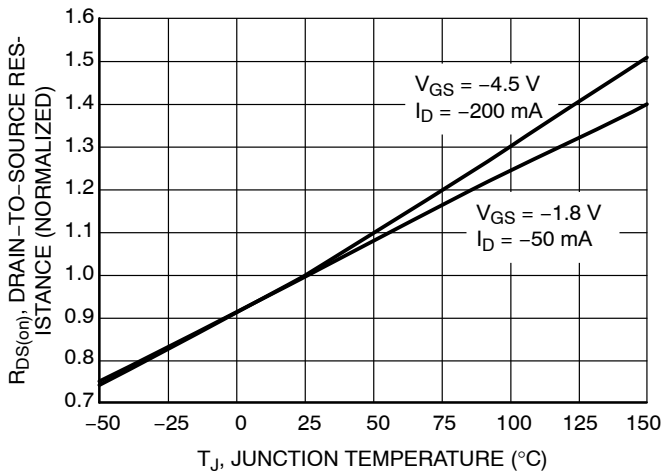

Figure 5. On-Resistance Variation with Temperature

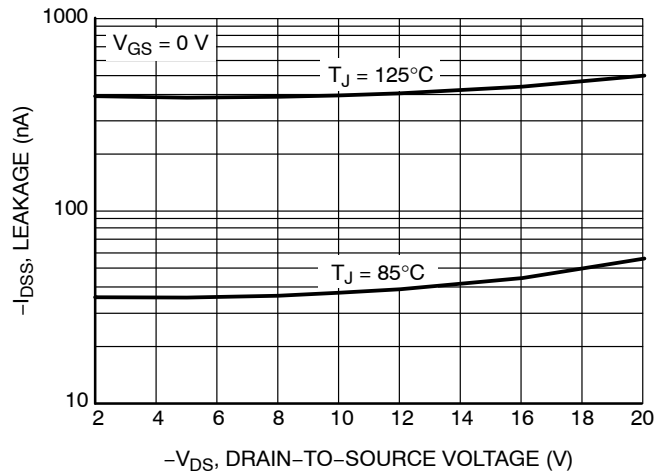

Figure 6. Drain-to-Source Leakage Current vs. Voltage

# NTNS3A65PZ

## TYPICAL CHARACTERISTICS

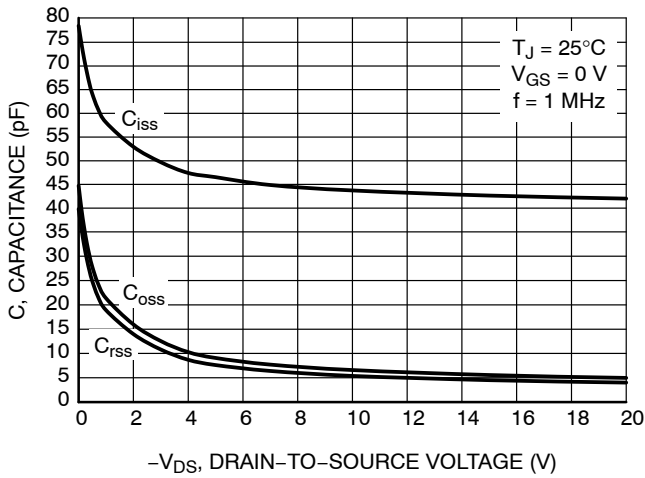

Figure 7. Capacitance Variation

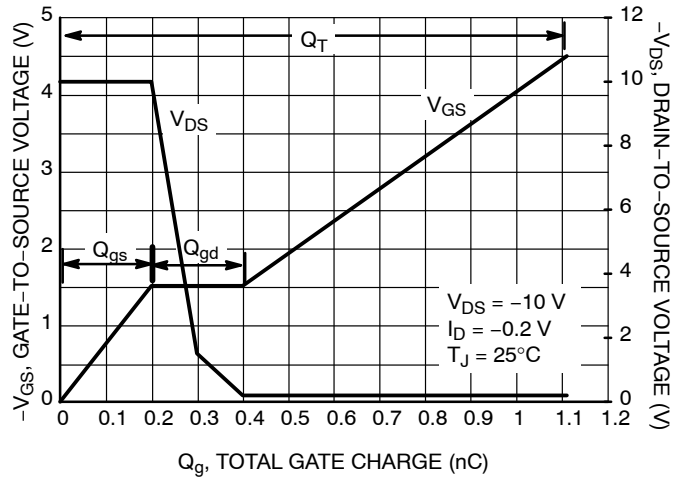

Figure 8. Gate-to-Source Voltage vs. Total Charge

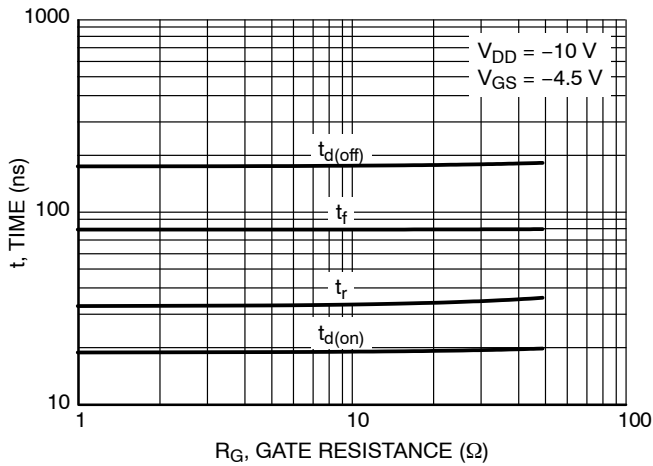

Figure 9. Resistive Switching Time Variation vs. Gate Resistance

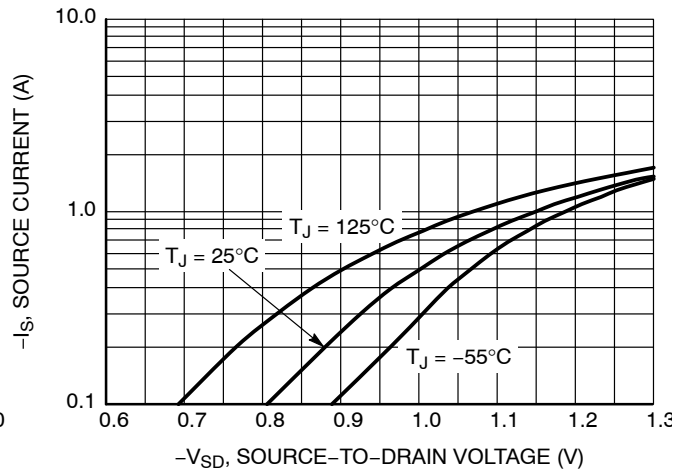

Figure 10. Diode Forward Voltage vs. Current

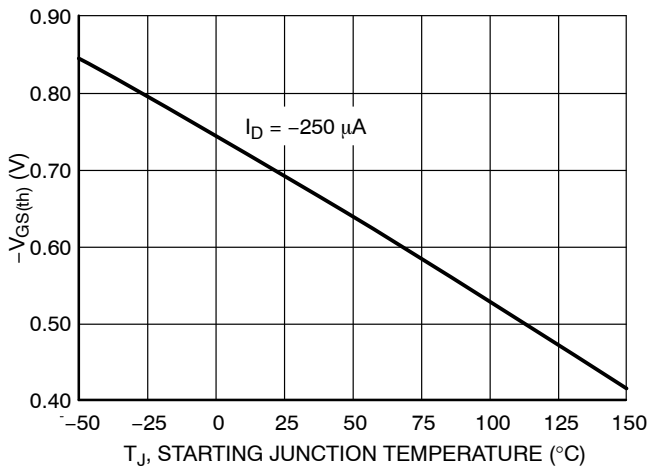

Figure 11. Threshold Voltage

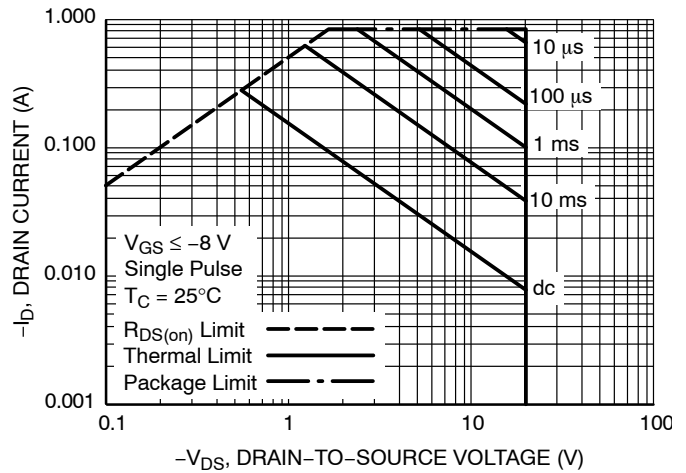

Figure 12. Maximum Rated Forward Biased Safe Operating Area

# NTNS3A65PZ

## TYPICAL CHARACTERISTICS

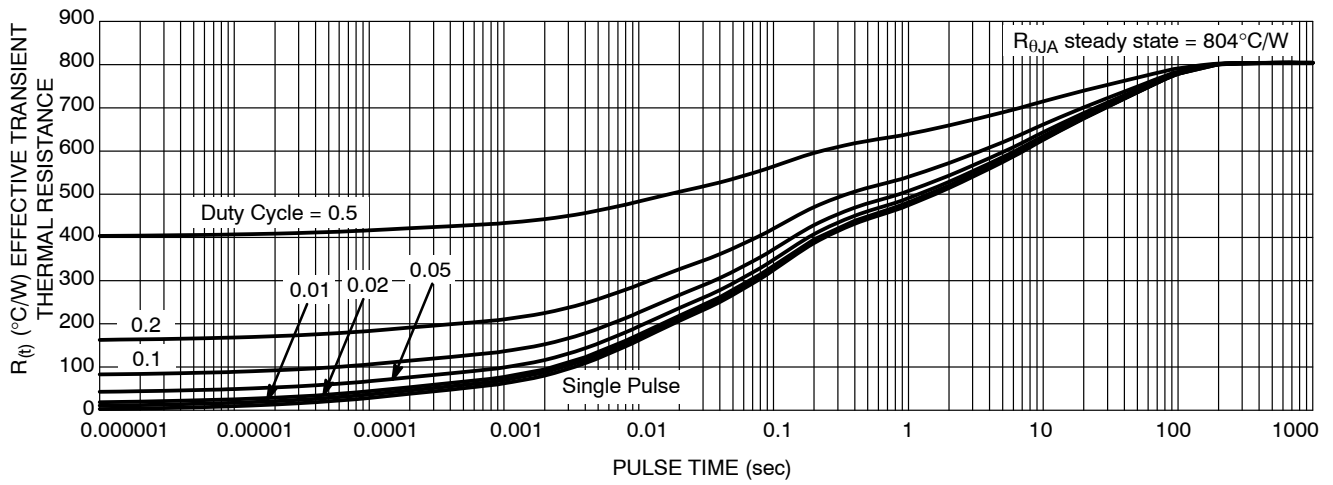

Figure 13. Thermal Response

# MECHANICAL CASE OUTLINE

## PACKAGE DIMENSIONS

ON Semiconductor®



SOT-883 (XDFN3), 1.0x0.6, 0.35P  
CASE 506CB  
ISSUE A

DATE 30 MAR 2012



SCALE 8:1

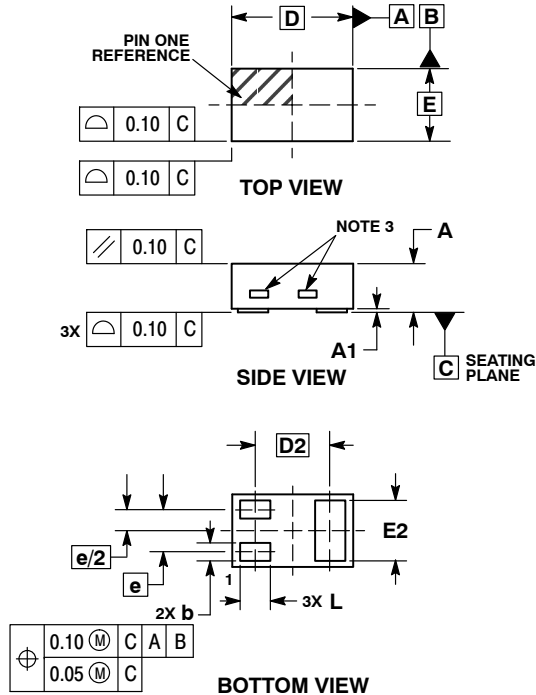

NOTES:

1. DIMENSIONING AND TOLERANCING PER ASME Y14.5M, 1994.
2. CONTROLLING DIMENSION: MILLIMETERS.
3. EXPOSED COPPER ALLOWED AS SHOWN.

| MILLIMETERS |           |       |
|-------------|-----------|-------|
| DIM         | MIN       | MAX   |
| A           | 0.340     | 0.440 |
| A1          | 0.000     | 0.030 |
| b           | 0.075     | 0.200 |
| D           | 0.950     | 1.075 |
| D2          | 0.620 BSC |       |
| e           | 0.350 BSC |       |
| E           | 0.550     | 0.675 |
| E2          | 0.425     | 0.550 |
| L           | 0.170     | 0.300 |

**GENERIC MARKING DIAGRAM\***

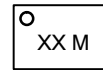

XX = Specific Device Code  
M = Date Code

\*This information is generic. Please refer to device data sheet for actual part marking. Pb-Free indicator, "G", may or not be present.

**RECOMMENDED SOLDER FOOTPRINT\***

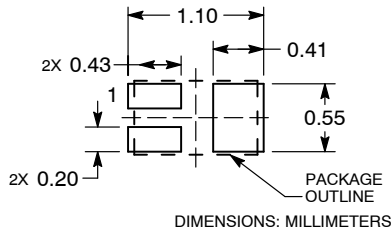

\*For additional information on our Pb-Free strategy and soldering details, please download the ON Semiconductor Soldering and Mounting Techniques Reference Manual, SOLDERRM/D.

|                         |  |  |
|-------------------------|--|--|
| <b>DOCUMENT NUMBER:</b> | <b>98AON65407E</b>                     | Electronic versions are uncontrolled except when accessed directly from the Document Repository. Printed versions are uncontrolled except when stamped "CONTROLLED COPY" in red. |
| <b>DESCRIPTION:</b>     | <b>SOT-883 (XDFN3), 1.0X0.6, 0.35P</b> | <b>PAGE 1 OF 1</b>   |

ON Semiconductor and are trademarks of Semiconductor Components Industries, LLC dba ON Semiconductor or its subsidiaries in the United States and/or other countries. ON Semiconductor reserves the right to make changes without further notice to any products herein. ON Semiconductor makes no warranty, representation or guarantee regarding the suitability of its products for any particular purpose, nor does ON Semiconductor assume any liability arising out of the application or use of any product or circuit, and specifically disclaims any and all liability, including without limitation special, consequential or incidental damages. ON Semiconductor does not convey any license under its patent rights nor the rights of others.

**onsemi**, **Onsemi**, and other names, marks, and brands are registered and/or common law trademarks of Semiconductor Components Industries, LLC dba "**onsemi**" or its affiliates and/or subsidiaries in the United States and/or other countries. **onsemi** owns the rights to a number of patents, trademarks, copyrights, trade secrets, and other intellectual property. A listing of **onsemi**'s product/patent coverage may be accessed at [www.onsemi.com/site/pdf/Patent-Marking.pdf](http://www.onsemi.com/site/pdf/Patent-Marking.pdf). **onsemi** reserves the right to make changes at any time to any products or information herein, without notice. The information herein is provided "as-is" and **onsemi** makes no warranty, representation or guarantee regarding the accuracy of the information, product features, availability, functionality, or suitability of its products for any particular purpose, nor does **onsemi** assume any liability arising out of the application or use of any product or circuit, and specifically disclaims any and all liability, including without limitation special, consequential or incidental damages. Buyer is responsible for its products and applications using **onsemi** products, including compliance with all laws, regulations and safety requirements or standards, regardless of any support or applications information provided by **onsemi**. "Typical" parameters which may be provided in **onsemi** data sheets and/or specifications can and do vary in different applications and actual performance may vary over time. All operating parameters, including "Typicals" must be validated for each customer application by customer's technical experts. **onsemi** does not convey any license under any of its intellectual property rights nor the rights of others. **onsemi** products are not designed, intended, or authorized for use as a critical component in life support systems or any FDA Class 3 medical devices or medical devices with a same or similar classification in a foreign jurisdiction or any devices intended for implantation in the human body. Should Buyer purchase or use **onsemi** products for any such unintended or unauthorized application, Buyer shall indemnify and hold **onsemi** and its officers, employees, subsidiaries, affiliates, and distributors harmless against all claims, costs, damages, and expenses, and reasonable attorney fees arising out of, directly or indirectly, any claim of personal injury or death associated with such unintended or unauthorized use, even if such claim alleges that **onsemi** was negligent regarding the design or manufacture of the part. **onsemi** is an Equal Opportunity/Affirmative Action Employer. This literature is subject to all applicable copyright laws and is not for resale in any manner.

## ADDITIONAL INFORMATION

### TECHNICAL PUBLICATIONS:

Technical Library: [www.onsemi.com/design/resources/technical-documentation](http://www.onsemi.com/design/resources/technical-documentation)  
onsemi Website: [www.onsemi.com](http://www.onsemi.com)

### ONLINE SUPPORT: [www.onsemi.com/support](http://www.onsemi.com/support)

For additional information, please contact your local Sales Representative at [www.onsemi.com/support/sales](http://www.onsemi.com/support/sales)