

ON Semiconductor

Is Now

onsemi™

To learn more about onsemi™, please visit our website at
www.onsemi.com

onsemi and **onsemi** and other names, marks, and brands are registered and/or common law trademarks of Semiconductor Components Industries, LLC dba "**onsemi**" or its affiliates and/or subsidiaries in the United States and/or other countries. **onsemi** owns the rights to a number of patents, trademarks, copyrights, trade secrets, and other intellectual property. A listing of **onsemi** product/patent coverage may be accessed at www.onsemi.com/site/pdf/Patent-Marking.pdf. **onsemi** reserves the right to make changes at any time to any products or information herein, without notice. The information herein is provided "as-is" and **onsemi** makes no warranty, representation or guarantee regarding the accuracy of the information, product features, availability, functionality, or suitability of its products for any particular purpose, nor does **onsemi** assume any liability arising out of the application or use of any product or circuit, and specifically disclaims any and all liability, including without limitation special, consequential or incidental damages. Buyer is responsible for its products and applications using **onsemi** products, including compliance with all laws, regulations and safety requirements or standards, regardless of any support or applications information provided by **onsemi**. "Typical" parameters which may be provided in **onsemi** data sheets and/or specifications can and do vary in different applications and actual performance may vary over time. All operating parameters, including "Typicals" must be validated for each customer application by customer's technical experts. **onsemi** does not convey any license under any of its intellectual property rights nor the rights of others. **onsemi** products are not designed, intended, or authorized for use as a critical component in life support systems or any FDA Class 3 medical devices or medical devices with a same or similar classification in a foreign jurisdiction or any devices intended for implantation in the human body. Should Buyer purchase or use **onsemi** products for any such unintended or unauthorized application, Buyer shall indemnify and hold **onsemi** and its officers, employees, subsidiaries, affiliates, and distributors harmless against all claims, costs, damages, and expenses, and reasonable attorney fees arising out of, directly or indirectly, any claim of personal injury or death associated with such unintended or unauthorized use, even if such claim alleges that **onsemi** was negligent regarding the design or manufacture of the part. **onsemi** is an Equal Opportunity/Affirmative Action Employer. This literature is subject to all applicable copyright laws and is not for resale in any manner. Other names and brands may be claimed as the property of others.

MOSFET - SiC Power, Single N-Channel

900 V, 60 mΩ, 46 A

NTH4L060N090SC1

Features

- Typ. $R_{DS(on)} = 60 \text{ m}\Omega @ V_{GS} = 15 \text{ V}$
Typ. $R_{DS(on)} = 43 \text{ m}\Omega @ V_{GS} = 18 \text{ V}$
- Ultra Low Gate Charge (typ. $Q_{G(tot)} = 87 \text{ nC}$)
- Low Effective Output Capacitance (typ. $C_{oss} = 113 \text{ pF}$)
- 100% UIL Tested
- These Devices are RoHS Compliant

Typical Applications

- UPS
- DC/DC Converter
- Boost Inverter

MAXIMUM RATINGS ($T_J = 25^\circ\text{C}$ unless otherwise noted)

Parameter		Symbol	Value	Unit
Drain-to-Source Voltage		V_{DSS}	900	V
Gate-to-Source Voltage		V_{GS}	+22/-8	V
Recommended Operation Values of Gate-to-Source Voltage	$T_C < 175^\circ\text{C}$	V_{GSop}	-5/+15	V
Continuous Drain Current $R_{\theta JC}$	Steady State $T_C = 25^\circ\text{C}$	I_D	46	A
Power Dissipation $R_{\theta JC}$		P_D	221	W
Continuous Drain Current $R_{\theta JC}$	Steady State $T_C = 100^\circ\text{C}$	I_D	32	A
Power Dissipation $R_{\theta JC}$		P_D	110	W
Pulsed Drain Current (Note 2)	$T_A = 25^\circ\text{C}$	I_{DM}	211	A
Operating Junction and Storage Temperature Range		T_J, T_{stg}	-55 to +175	$^\circ\text{C}$
Source Current (Body Diode)		I_S	22	A
Single Pulse Drain-to-Source Avalanche Energy ($I_{L(pk)} = 18 \text{ A}, L = 1 \text{ mH}$) (Note 3)		E_{AS}	162	mJ

Stresses exceeding those listed in the Maximum Ratings table may damage the device. If any of these limits are exceeded, device functionality should not be assumed, damage may occur and reliability may be affected.

THERMAL RESISTANCE MAXIMUM RATINGS

Parameter	Symbol	Value	Unit
Junction-to-Case (Note 1)	$R_{\theta JC}$	0.68	$^\circ\text{C}/\text{W}$
Junction-to-Ambient (Note 1)	$R_{\theta JA}$	40	$^\circ\text{C}/\text{W}$

1. The entire application environment impacts the thermal resistance values shown, they are not constants and are only valid for the particular conditions noted.
2. Repetitive rating, limited by max junction temperature.
3. E_{AS} of 162 mJ is based on starting $T_J = 25^\circ\text{C}$; $L = 1 \text{ mH}$, $I_{AS} = 18 \text{ A}$, $V_{DD} = 100 \text{ V}$, $V_{GS} = 15 \text{ V}$.



ON Semiconductor®

www.onsemi.com

$V_{(BR)DSS}$	$R_{DS(on)} \text{ MAX}$	$I_D \text{ MAX}$
900 V	84 mΩ @ 15 V	46 A

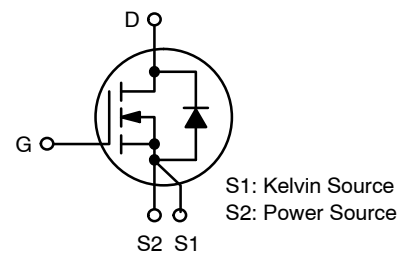

N-CHANNEL MOSFET

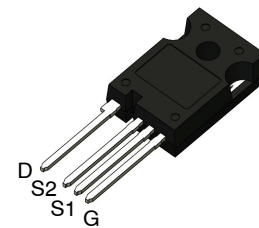

TO247-4L
CASE 340CJ

MARKING DIAGRAM



H4L060090SC1 = Specific Device Code
A = Assembly Site
Y = Year of Production
WW = Work Week Number
ZZ = Assembly Lot Number

ORDERING INFORMATION

See detailed ordering and shipping information on page 2 of this data sheet.

NTH4L060N090SC1

ELECTRICAL CHARACTERISTICS

Parameter	Symbol	Test Conditions	Min	Typ	Max	Unit
-----------	--------	-----------------	-----	-----	-----	------

OFF CHARACTERISTICS

Drain-to-Source Breakdown Voltage	$V_{(BR)DSS}$	$V_{GS} = 0\text{ V}, I_D = 1\text{ mA}$	900			V
Drain-to-Source Breakdown Voltage Temperature Coefficient	$V_{(BR)DSS}/T_J$	$I_D = 1\text{ mA}$, referenced to 25°C		574		mV/ $^\circ\text{C}$
Zero Gate Voltage Drain Current	I_{DSS}	$V_{GS} = 0\text{ V}, V_{DS} = 900\text{ V}, T_J = 25^\circ\text{C}$			100	μA
		$V_{GS} = 0\text{ V}, V_{DS} = 900\text{ V}, T_J = 175^\circ\text{C}$			250	
Gate-to-Source Leakage Current	I_{GSS}	$V_{GS} = +22/-8\text{ V}, V_{DS} = 0\text{ V}$			± 1	μA

ON CHARACTERISTICS

Gate Threshold Voltage	$V_{GS(th)}$	$V_{GS} = V_{DS}, I_D = 5\text{ mA}$	1.8	2.7	4.3	V
Recommended Gate Voltage	V_{GOP}		-5		+15	V
Drain-to-Source On Resistance	$R_{DS(on)}$	$V_{GS} = 15\text{ V}, I_D = 20\text{ A}, T_J = 25^\circ\text{C}$		60	84	m Ω
		$V_{GS} = 18\text{ V}, I_D = 20\text{ A}, T_J = 25^\circ\text{C}$		43		
		$V_{GS} = 15\text{ V}, I_D = 20\text{ A}, T_J = 175^\circ\text{C}$		76		
Forward Transconductance	g_{FS}	$V_{DS} = 20\text{ V}, I_D = 20\text{ A}$		17		S

CHARGES, CAPACITANCES & GATE RESISTANCE

Input Capacitance	C_{ISS}	$V_{GS} = 0\text{ V}, f = 1\text{ MHz}, V_{DS} = 450\text{ V}$		1770		pF
Output Capacitance	C_{OSS}			113		
Reverse Transfer Capacitance	C_{RSS}			11		
Total Gate Charge	$Q_{G(tot)}$	$V_{GS} = -5/15\text{ V}, V_{DS} = 720\text{ V}, I_D = 10\text{ A}$		87		nC
Threshold Gate Charge	$Q_{G(th)}$			17		
Gate-to-Source Charge	Q_{GS}			27		
Gate-to-Drain Charge	Q_{GD}			26		
Gate Resistance	R_G	$f = 1\text{ MHz}$		3.0		Ω

SWITCHING CHARACTERISTICS

Turn-On Delay Time	$t_{d(on)}$	$V_{GS} = -5/15\text{ V}, V_{DS} = 720\text{ V}, I_D = 20\text{ A}, R_G = 2.5\ \Omega,$ Inductive Load		17	31	ns
Rise Time	t_r			15	27	
Turn-Off Delay Time	$t_{d(off)}$			29	47	
Fall Time	t_f			11	20	
Turn-On Switching Loss	E_{ON}			183		μJ
Turn-Off Switching Loss	E_{OFF}			52		
Total Switching Loss	E_{TOT}		235			

DRAIN-SOURCE DIODE CHARACTERISTICS

Continuous Drain-to-Source Diode Forward Current	I_{SD}	$V_{GS} = -5\text{ V}, T_J = 25^\circ\text{C}$			22	A
Pulsed Drain-to-Source Diode Forward Current (Note 2)	I_{SDM}	$V_{GS} = -5\text{ V}, T_J = 25^\circ\text{C}$			184	A
Forward Diode Voltage	V_{SD}	$V_{GS} = -5\text{ V}, I_{SD} = 10\text{ A}, T_J = 25^\circ\text{C}$		3.9		V
Reverse Recovery Time	t_{RR}	$V_{GS} = -5/15\text{ V}, I_{SD} = 30\text{ A}, dI_S/dt = 1000\text{ A}/\mu\text{s}, V_{DS} = 720\text{ V}$		18		ns
Reverse Recovery Charge	Q_{RR}			84		nC
Reverse Recovery Energy	E_{REC}			1.0		μJ
Peak Reverse Recovery Current	I_{RRM}			9.0		A
Charge Time	t_a			10		ns
Discharge Time	t_b			8.0		ns

Product parametric performance is indicated in the Electrical Characteristics for the listed test conditions, unless otherwise noted. Product performance may not be indicated by the Electrical Characteristics if operated under different conditions.

TYPICAL CHARACTERISTICS

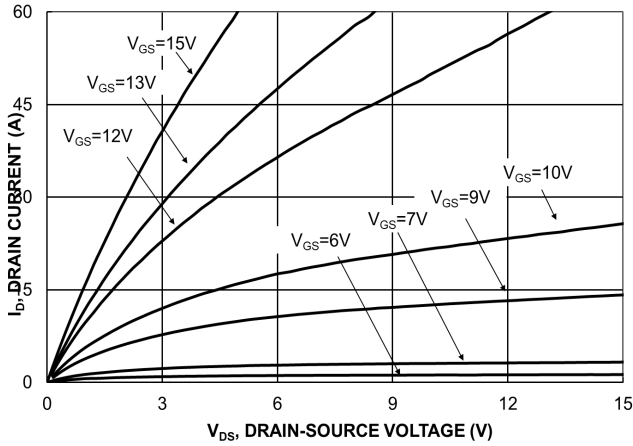

Figure 1. On-Region Characteristics

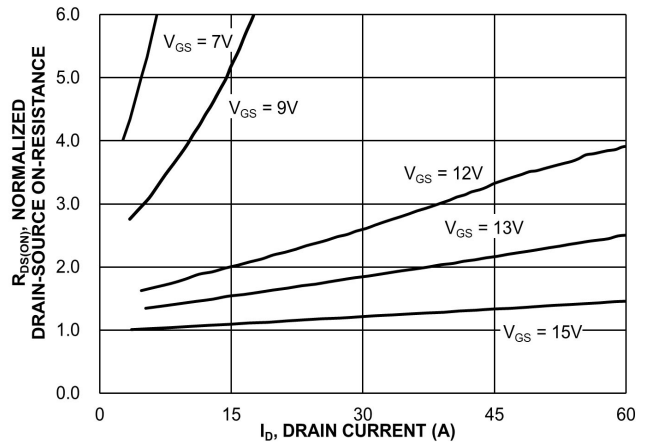

Figure 2. Normalized On-Resistance vs. Drain Current and Gate Voltage

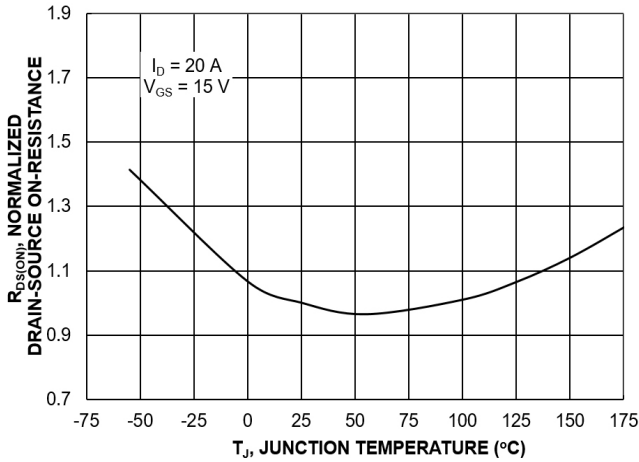

Figure 3. On-Resistance Variation with Temperature

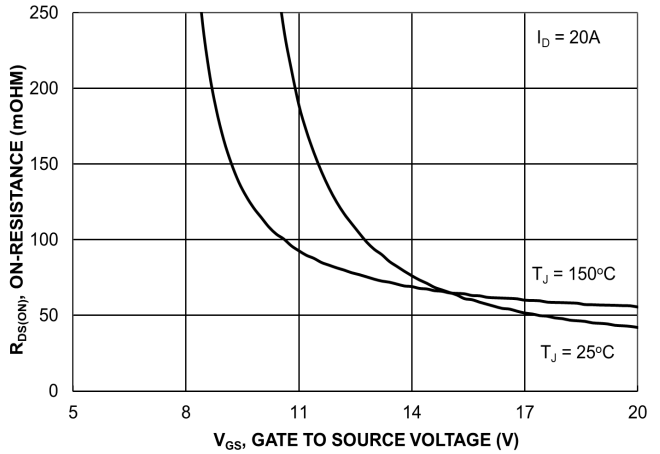

Figure 4. On-Resistance vs. Gate-to-Source Voltage

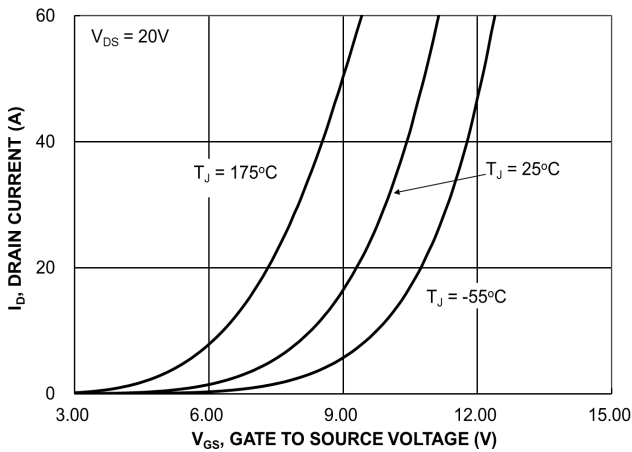

Figure 5. Transfer Characteristics

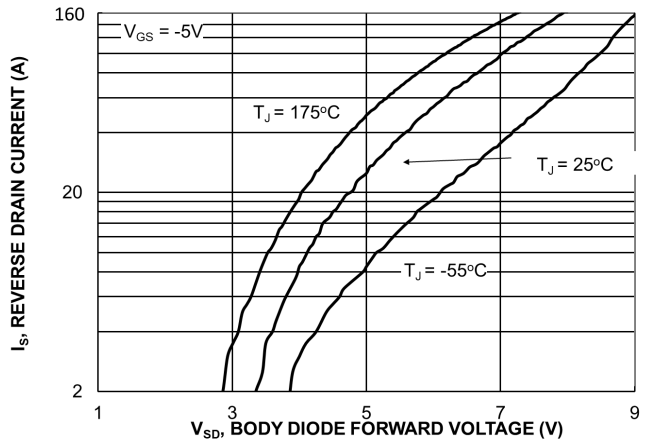

Figure 6. Diode Forward Voltage vs. Current

NTH4L060N090SC1

TYPICAL CHARACTERISTICS

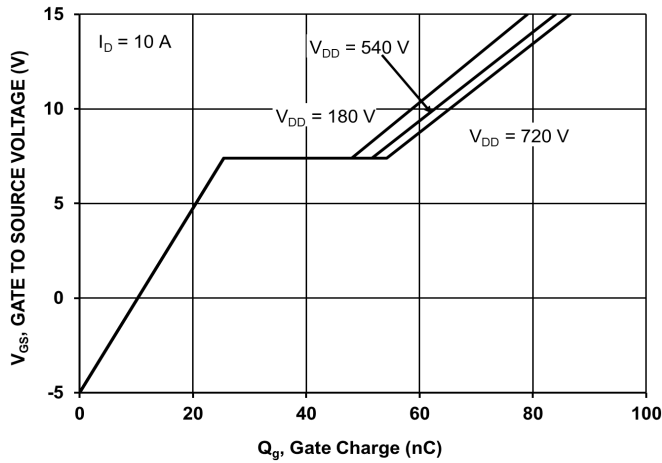

Figure 7. Gate-to-Source Voltage vs. Total Charge

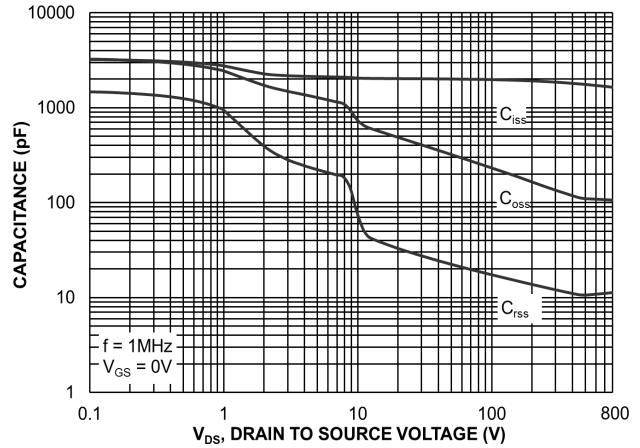

Figure 8. Capacitance vs. Drain-to-Source Voltage

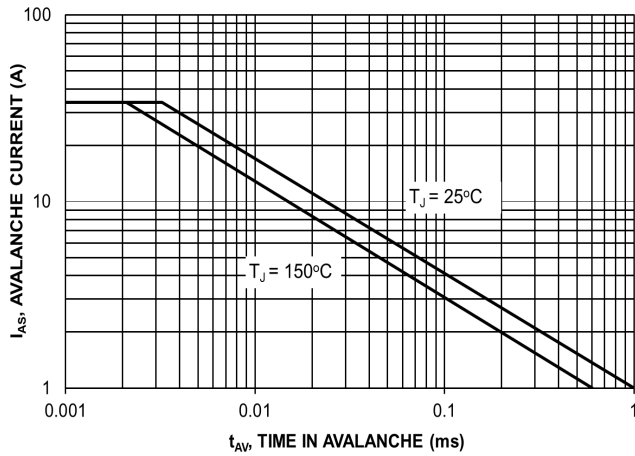

Figure 9. Unclamped Inductive Switching Capability

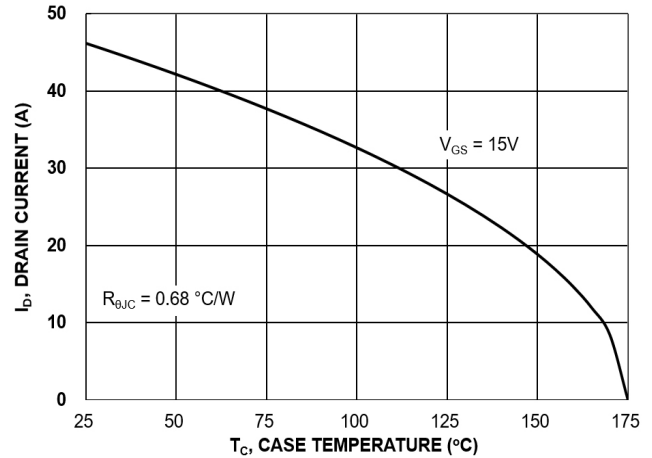

Figure 10. Maximum Continuous Drain Current vs. Case Temperature

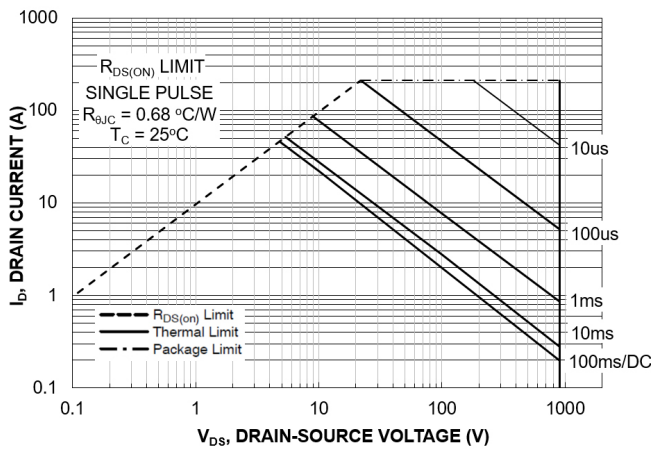

Figure 11. Safe Operating Area

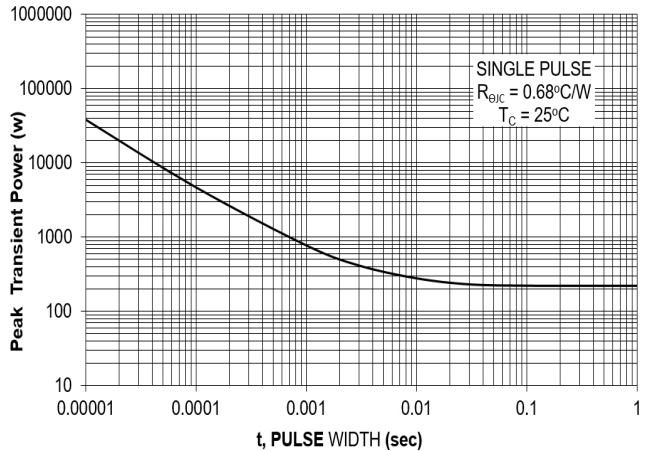

Figure 12. Single Pulse Maximum Power Dissipation

NTH4L060N090SC1

TYPICAL CHARACTERISTICS

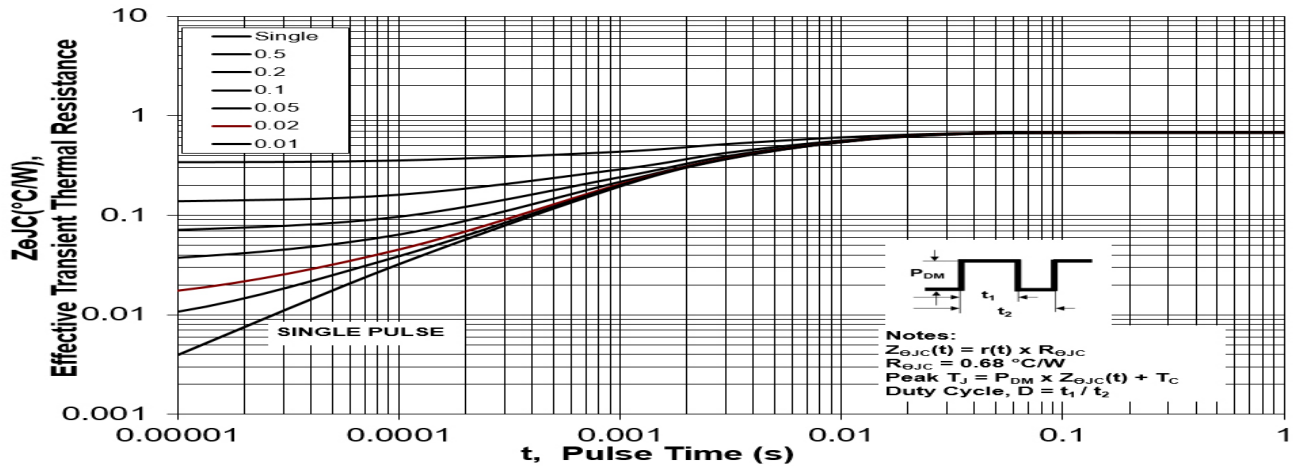

Figure 13. Junction-to-Ambient Thermal Response

PACKAGE MARKING AND ORDERING INFORMATION

Part Number	Top Marking	Package	Packing Method	Reel Size	Tape Width	Quantity
NTH4L060N090SC1	H4L060 090SC1	TO247-4L	Tube	N/A	N/A	30 Units

NTH4L060N090SC1

PACKAGE DIMENSIONS

TO-247-4LD
CASE 340CJ
ISSUE A

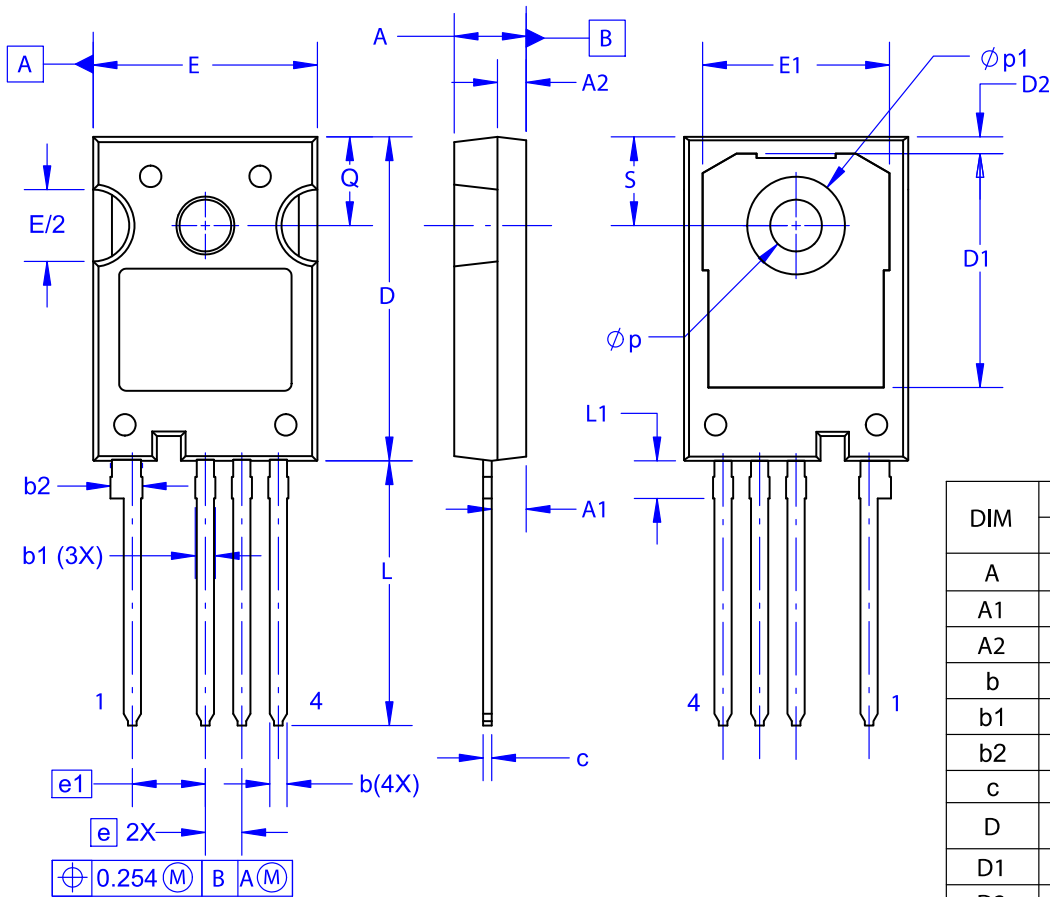

DIM	MILLIMETERS		
	MIN	NOM	MAX
A	4.80	5.00	5.20
A1	2.10	2.40	2.70
A2	1.80	2.00	2.20
b	1.07	1.20	1.33
b1	1.20	1.40	1.60
b2	2.02	2.22	2.42
c	0.50	0.60	0.70
D	22.34	22.54	22.74
D1	16.00	16.25	16.50
D2	0.97	1.17	1.37
e	2.54 BSC		
e1	5.08 BSC		
E	15.40	15.60	15.80
E1	12.80	13.00	13.20
E/2	4.80	5.00	5.20
L	18.22	18.42	18.62
L1	2.42	2.62	2.82
p	3.40	3.60	3.80
p1	6.60	6.80	7.00
Q	5.97	6.17	6.37
S	5.97	6.17	6.37

NOTES:

- A. NO INDUSTRY STANDARD APPLIES TO THIS PACKAGE.
- B. DIMENSIONS ARE EXCLUSIVE OF BURRS, MOLD FLASH, AND TIE BAR EXTRUSIONS.
- C. ALL DIMENSIONS ARE IN MILLIMETERS.
- D. DRAWING CONFORMS TO ASME Y14.5-2009.

ON Semiconductor and  are trademarks of Semiconductor Components Industries, LLC dba ON Semiconductor or its subsidiaries in the United States and/or other countries. ON Semiconductor owns the rights to a number of patents, trademarks, copyrights, trade secrets, and other intellectual property. A listing of ON Semiconductor's product/patent coverage may be accessed at www.onsemi.com/site/pdf/Patent-Marking.pdf. ON Semiconductor reserves the right to make changes without further notice to any products herein. ON Semiconductor makes no warranty, representation or guarantee regarding the suitability of its products for any particular purpose, nor does ON Semiconductor assume any liability arising out of the application or use of any product or circuit, and specifically disclaims any and all liability, including without limitation special, consequential or incidental damages. Buyer is responsible for its products and applications using ON Semiconductor products, including compliance with all laws, regulations and safety requirements or standards, regardless of any support or applications information provided by ON Semiconductor. "Typical" parameters which may be provided in ON Semiconductor data sheets and/or specifications can and do vary in different applications and actual performance may vary over time. All operating parameters, including "Typicals" must be validated for each customer application by customer's technical experts. ON Semiconductor does not convey any license under its patent rights nor the rights of others. ON Semiconductor products are not designed, intended, or authorized for use as a critical component in life support systems or any FDA Class 3 medical devices or medical devices with a same or similar classification in a foreign jurisdiction or any devices intended for implantation in the human body. Should Buyer purchase or use ON Semiconductor products for any such unintended or unauthorized application, Buyer shall indemnify and hold ON Semiconductor and its officers, employees, subsidiaries, affiliates, and distributors harmless against all claims, costs, damages, and expenses, and reasonable attorney fees arising out of, directly or indirectly, any claim of personal injury or death associated with such unintended or unauthorized use, even if such claim alleges that ON Semiconductor was negligent regarding the design or manufacture of the part. ON Semiconductor is an Equal Opportunity/Affirmative Action Employer. This literature is subject to all applicable copyright laws and is not for resale in any manner.

PUBLICATION ORDERING INFORMATION

LITERATURE FULFILLMENT:

Email Requests to: orderlit@onsemi.com

ON Semiconductor Website: www.onsemi.com

TECHNICAL SUPPORT

North American Technical Support:
Voice Mail: 1 800-282-9855 Toll Free USA/Canada
Phone: 011 421 33 790 2910

Europe, Middle East and Africa Technical Support:

Phone: 00421 33 790 2910

For additional information, please contact your local Sales Representative