

NST3946DP6T5G

Dual Complementary General Purpose Transistor

The NST3946DP6T5G device is a spin-off of our popular SOT-23/SOT-323/SOT-563 three-leaded device. It is designed for general purpose amplifier applications and is housed in the SOT-963 six-leaded surface mount package. By putting two discrete devices in one package, this device is ideal for low-power surface mount applications where board space is at a premium.

Features

- h_{FE} , 100–300
- Low $V_{CE(sat)}$, ≤ 0.4 V
- Reduces Board Space and Component Count
- NSV Prefix for Automotive and Other Applications Requiring Unique Site and Control Change Requirements; AEC-Q101 Qualified and PPAP Capable
- These Devices are Pb-Free, Halogen Free and are RoHS Compliant

MAXIMUM RATINGS

Rating	Symbol	Value	Unit
Collector – Emitter Voltage	V_{CEO}	40	Vdc
Collector – Base Voltage	V_{CBO}	60	Vdc
Emitter – Base Voltage	V_{EBO}	6.0	Vdc
Collector Current – Continuous	I_C	200	mAdc
Electrostatic Discharge	HBM MM	ESD Class 2 B	

THERMAL CHARACTERISTICS

Characteristic (Single Heated)	Symbol	Max	Unit
Total Device Dissipation $T_A = 25^\circ\text{C}$ Derate above 25°C (Note 1)	P_D	240 1.9	mW mW/ $^\circ\text{C}$
Thermal Resistance, Junction-to-Ambient (Note 1)	$R_{\theta JA}$	520	$^\circ\text{C}/\text{W}$
Total Device Dissipation $T_A = 25^\circ\text{C}$ Derate above 25°C (Note 2)	P_D	280 2.2	mW mW/ $^\circ\text{C}$
Thermal Resistance, Junction-to-Ambient (Note 2)	$R_{\theta JA}$	446	$^\circ\text{C}/\text{W}$
Characteristic (Dual Heated) (Note 3)	Symbol	Max	Unit
Total Device Dissipation $T_A = 25^\circ\text{C}$ Derate above 25°C (Note 1)	P_D	350 2.8	mW mW/ $^\circ\text{C}$
Thermal Resistance, Junction-to-Ambient (Note 1)	$R_{\theta JA}$	357	$^\circ\text{C}/\text{W}$
Total Device Dissipation $T_A = 25^\circ\text{C}$ Derate above 25°C (Note 2)	P_D	420 3.4	mW mW/ $^\circ\text{C}$
Thermal Resistance, Junction-to-Ambient (Note 2)	$R_{\theta JA}$	297	$^\circ\text{C}/\text{W}$
Junction and Storage Temperature Range	T_J, T_{stg}	-55 to +150	$^\circ\text{C}$

Stresses exceeding those listed in the Maximum Ratings table may damage the device. If any of these limits are exceeded, device functionality should not be assumed, damage may occur and reliability may be affected.

1. FR-4 @ 100 mm², 1 oz. copper traces, still air.
2. FR-4 @ 500 mm², 1 oz. copper traces, still air.
3. Dual heated values assume total power is sum of two equally powered channels



ON Semiconductor®

www.onsemi.com

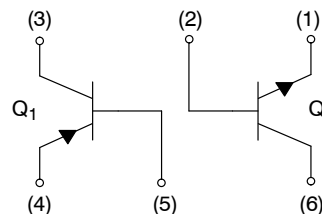

NST3946DP6T5G*

*Q1 PNP
Q2 NPN

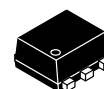

SOT-963
CASE 527AD

MARKING DIAGRAM

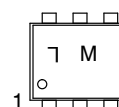

L = Device Code
(180° Clockwise Rotation)
M = Date Code

ORDERING INFORMATION

Device	Package	Shipping†
NST3946DP6T5G	SOT-963 (Pb-Free)	8000/Tape & Reel
NSVT3946DP6T5G	SOT-963 (Pb-Free)	8000/Tape & Reel

†For information on tape and reel specifications, including part orientation and tape sizes, please refer to our Tape and Reel Packaging Specifications Brochure, BRD8011/D.

NST3946DP6T5G

ELECTRICAL CHARACTERISTICS (T_A = 25°C unless otherwise noted)

Characteristic	Symbol	Min	Max	Unit	
OFF CHARACTERISTICS					
Collector–Emitter Breakdown Voltage (Note 4) (I _C = 1.0 mA, I _B = 0) (I _C = -1.0 mA, I _B = 0)	(NPN) (PNP)	V _{(BR)CEO}	40 -40	- -	Vdc
Collector–Base Breakdown Voltage (I _E = 10 μA, I _C = 0) (I _E = -10 μA, I _C = 0)	(NPN) (PNP)	V _{(BR)CBO}	60 -40	- -	Vdc
Emitter–Base Breakdown Voltage (I _E = 10 μA, I _C = 0) (I _E = -10 μA, I _C = 0)	(NPN) (PNP)	V _{(BR)EBO}	6.0 -5.0	- -	Vdc
Collector Cutoff Current (V _{CE} = 30 Vdc, V _{EB} = 3.0 Vdc) (V _{CE} = -30 Vdc, V _{EB} = -3.0 Vdc)	(NPN) (PNP)	I _{CEX}	- -	50 -50	nAdc
ON CHARACTERISTICS (Note 4)					
DC Current Gain (I _C = 0.1 mA, V _{CE} = 1.0 Vdc) (I _C = 1.0 mA, V _{CE} = 1.0 Vdc) (I _C = 10 mA, V _{CE} = 1.0 Vdc) (I _C = 50 mA, V _{CE} = 1.0 Vdc) (I _C = 100 mA, V _{CE} = 1.0 Vdc) (I _C = -0.1 mA, V _{CE} = -1.0 Vdc) (I _C = -1.0 mA, V _{CE} = -1.0 Vdc) (I _C = -10 mA, V _{CE} = -1.0 Vdc) (I _C = -50 mA, V _{CE} = -1.0 Vdc) (I _C = -100 mA, V _{CE} = -1.0 Vdc)	(NPN) (PNP)	h _{FE}	40 70 100 60 30 60 80 100 60 30	- - 300 - - - - 300 - -	-
Collector–Emitter Saturation Voltage (I _C = 10 mA, I _B = 1.0 mA) (I _C = 50 mA, I _B = 5.0 mA) (I _C = -10 mA, I _B = -1.0 mA) (I _C = -50 mA, I _B = -5.0 mA)	(NPN) (PNP)	V _{CE(sat)}	- - - -	0.2 0.3 -0.25 -0.4	Vdc
Base–Emitter Saturation Voltage (I _C = 10 mA, I _B = 1.0 mA) (I _C = 50 mA, I _B = 5.0 mA) (I _C = -10 mA, I _B = -1.0 mA) (I _C = -50 mA, I _B = -5.0 mA)	(NPN) (PNP)	V _{BE(sat)}	0.65 - -0.65 -	0.85 0.95 -0.85 -0.95	Vdc

4. Pulse Test: Pulse Width ≤ 300 μs; Duty Cycle ≤ 2.0%.

NST3946DP6T5G

ELECTRICAL CHARACTERISTICS ($T_A = 25^\circ\text{C}$ unless otherwise noted) (Continued)

Characteristic	Symbol	Min	Max	Unit
SMALL-SIGNAL CHARACTERISTICS				
Current - Gain - Bandwidth Product ($I_C = 10\text{ mAdc}$, $V_{CE} = 20\text{ Vdc}$, $f = 100\text{ MHz}$) (NPN) ($I_C = -10\text{ mAdc}$, $V_{CE} = -20\text{ Vdc}$, $f = 100\text{ MHz}$) (PNP)	f_T	200 250	- -	MHz
Output Capacitance ($V_{CB} = 5.0\text{ Vdc}$, $I_E = 0$, $f = 1.0\text{ MHz}$) (NPN) ($V_{CB} = -5.0\text{ Vdc}$, $I_E = 0$, $f = 1.0\text{ MHz}$) (PNP)	C_{obo}	- -	4.0 4.5	pF
Input Capacitance ($V_{EB} = 0.5\text{ Vdc}$, $I_C = 0$, $f = 1.0\text{ MHz}$) (NPN) ($V_{EB} = -0.5\text{ Vdc}$, $I_C = 0$, $f = 1.0\text{ MHz}$) (PNP)	C_{ibo}	- -	8.0 10.0	pF
Noise Figure ($V_{CE} = 5.0\text{ Vdc}$, $I_C = 100\text{ }\mu\text{A}$, $R_S = 1.0\text{ k}\Omega$, $f = 1.0\text{ kHz}$) (NPN) ($V_{CE} = -5.0\text{ Vdc}$, $I_C = -100\text{ }\mu\text{A}$, $R_S = 1.0\text{ k}\Omega$, $f = 1.0\text{ kHz}$) (PNP)	NF	- -	5.0 4.0	dB

SWITCHING CHARACTERISTICS

Delay Time	($V_{CC} = 3.0\text{ Vdc}$, $V_{BE} = -0.5\text{ Vdc}$) (NPN) ($V_{CC} = -3.0\text{ Vdc}$, $V_{BE} = 0.5\text{ Vdc}$) (PNP)	t_d	- -	35 35	ns
Rise Time	($I_C = 10\text{ mAdc}$, $I_{B1} = 1.0\text{ mAdc}$) (NPN) ($I_C = -10\text{ mAdc}$, $I_{B1} = -1.0\text{ mAdc}$) (PNP)	t_r	- -	35 35	
Storage Time	($V_{CC} = 3.0\text{ Vdc}$, $I_C = 10\text{ mAdc}$) (NPN) ($V_{CC} = -3.0\text{ Vdc}$, $I_C = -10\text{ mAdc}$) (PNP)	t_s	- -	275 250	ns
Fall Time	($I_{B1} = I_{B2} = 1.0\text{ mAdc}$) (NPN) ($I_{B1} = I_{B2} = -1.0\text{ mAdc}$) (PNP)	t_f	- -	50 50	

NPN TRANSISTOR

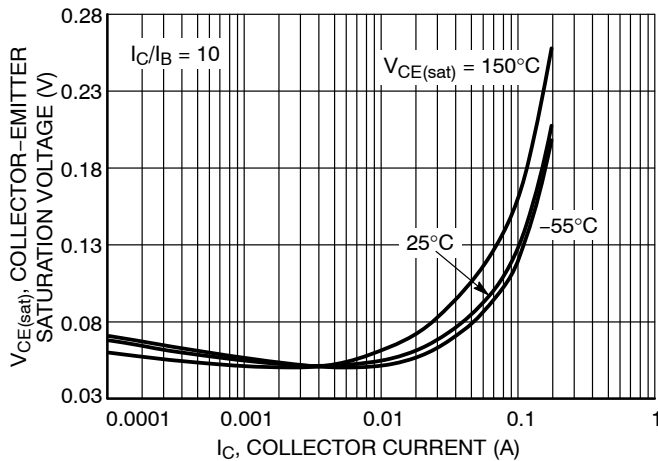

Figure 1. Collector Emitter Saturation Voltage vs. Collector Current

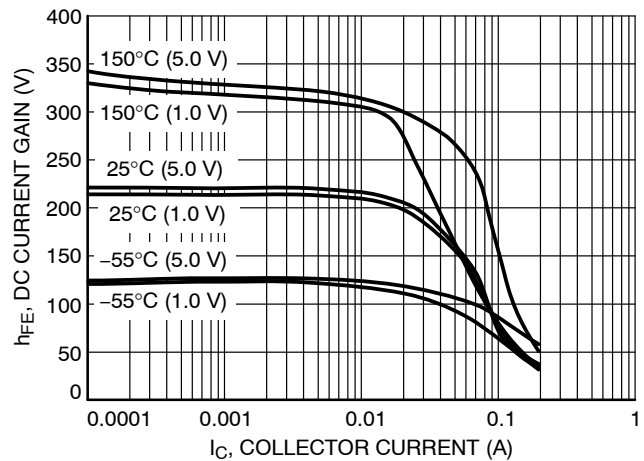

Figure 2. DC Current Gain vs. Collector Current

NST3946DP6T5G

NPN TRANSISTOR

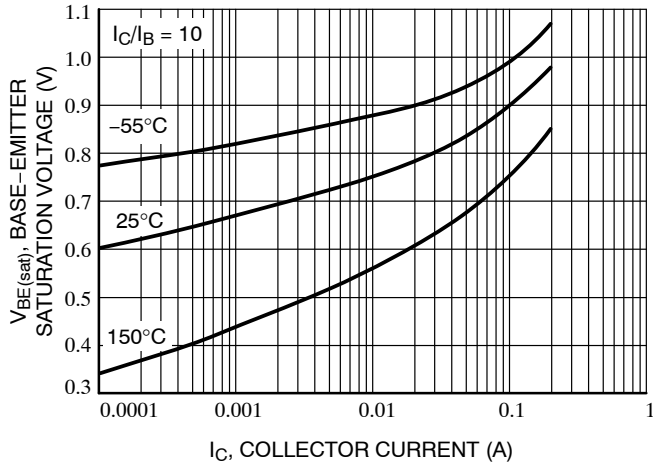

Figure 3. Base-Emitter Saturation Voltage vs. Collector Current

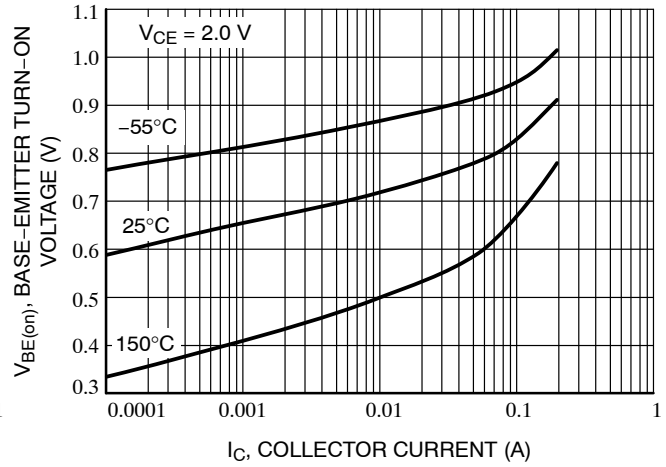

Figure 4. Base-Emitter Turn-On Voltage vs. Collector Current

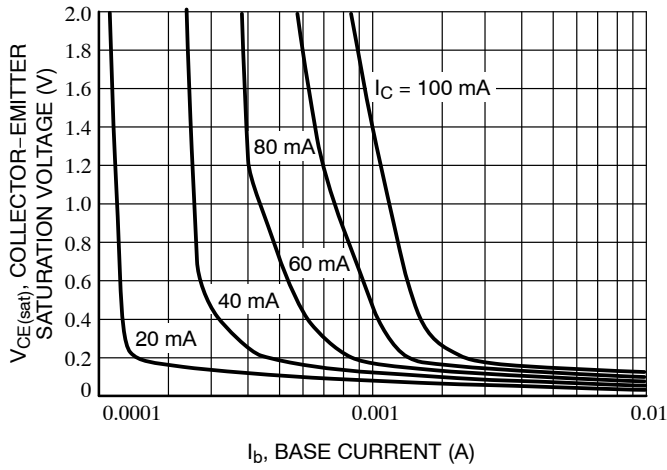

Figure 5. Saturation Region

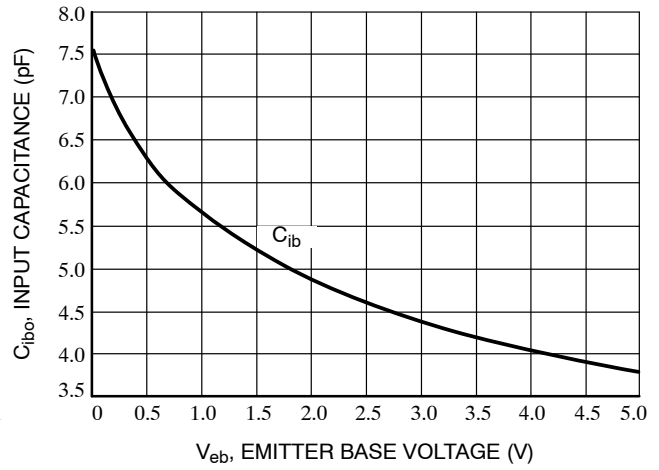

Figure 6. Input Capacitance

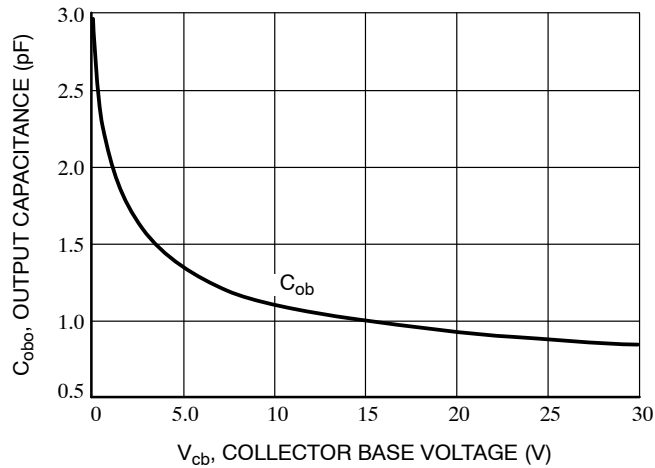

Figure 7. Output Capacitance

NST3946DP6T5G

PNP TRANSISTOR

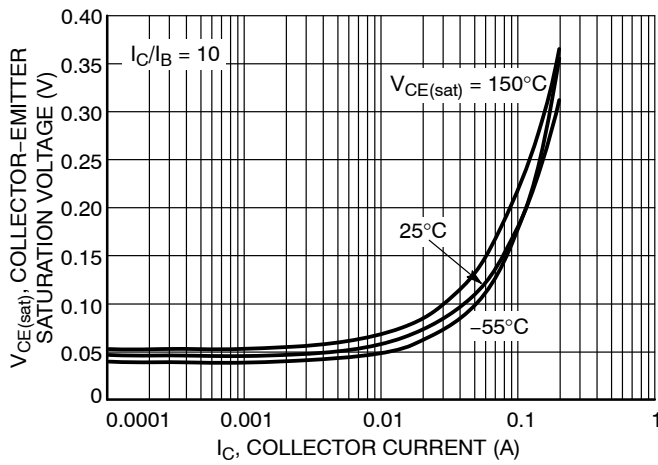

Figure 8. Collector-Emitter Saturation Voltage vs. Collector Current

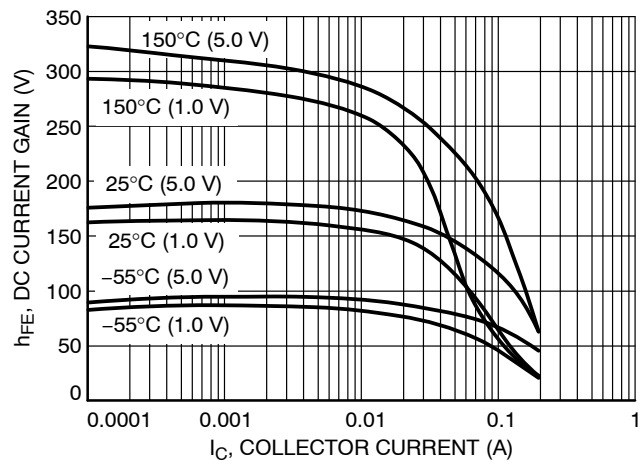

Figure 9. DC Current Gain vs. Collector Current

NST3946DP6T5G

PNP TRANSISTOR

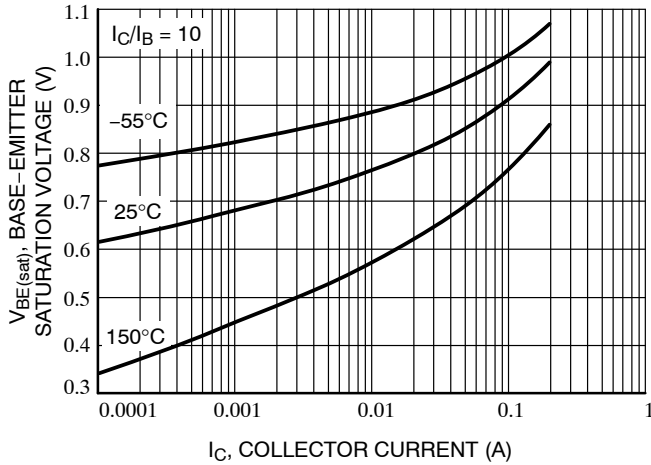

Figure 10. Base-Emitter Saturation Voltage vs. Collector Current

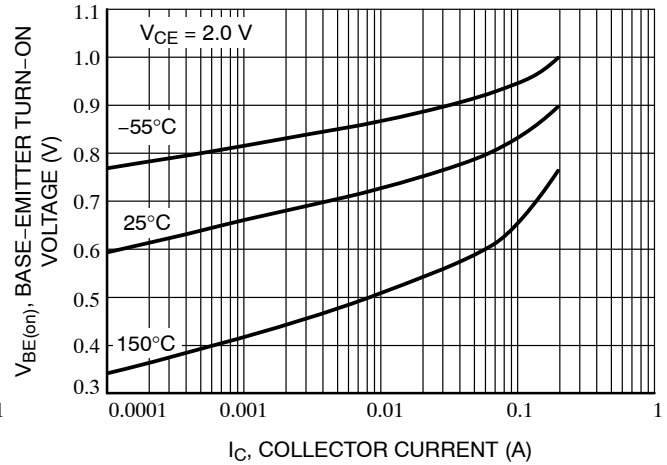

Figure 11. Base-Emitter Turn-On Voltage vs. Collector Current

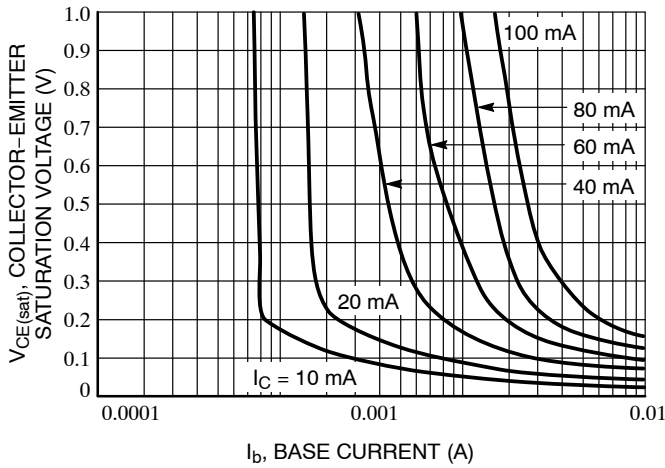

Figure 12. Saturation Region

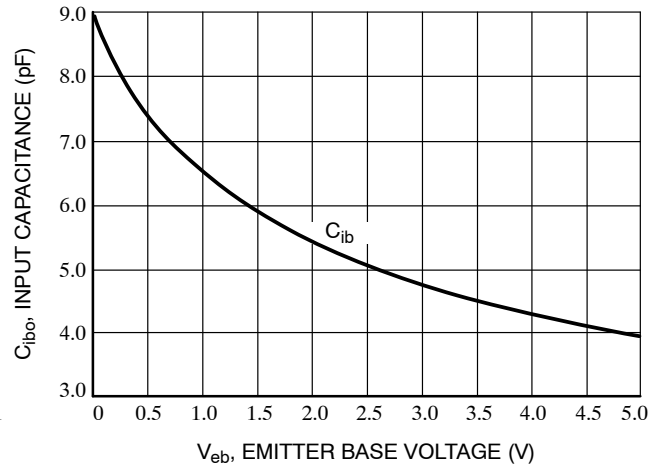

Figure 13. Input Capacitance

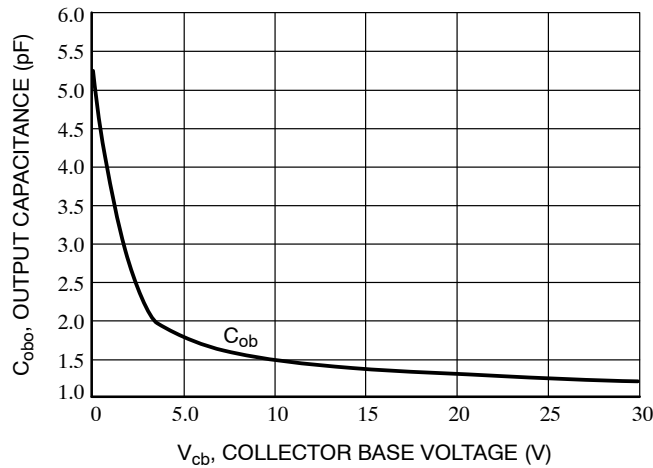

Figure 14. Output Capacitance

MECHANICAL CASE OUTLINE

PACKAGE DIMENSIONS

ON Semiconductor®



SCALE 4:1

SOT-963
CASE 527AD-01
ISSUE E

DATE 09 FEB 2010

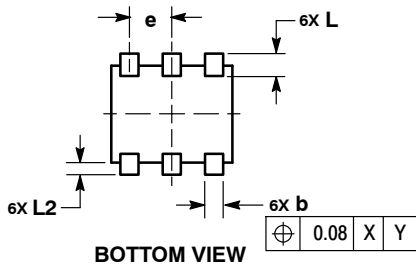
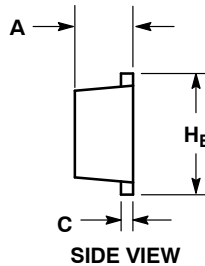
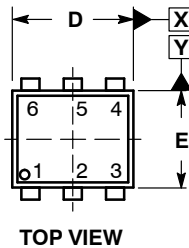

NOTES:

1. DIMENSIONING AND TOLERANCING PER ASME Y14.5M, 1994.
2. CONTROLLING DIMENSION: MILLIMETERS
3. MAXIMUM LEAD THICKNESS INCLUDES LEAD FINISH THICKNESS. MINIMUM LEAD THICKNESS IS THE MINIMUM THICKNESS OF BASE MATERIAL.
4. DIMENSIONS D AND E DO NOT INCLUDE MOLD FLASH, PROTRUSIONS, OR GATE BURRS.

MILLIMETERS			
DIM	MIN	NOM	MAX
A	0.34	0.37	0.40
b	0.10	0.15	0.20
C	0.07	0.12	0.17
D	0.95	1.00	1.05
E	0.75	0.80	0.85
e	0.35 BSC		
H _E	0.95	1.00	1.05
L	0.19 REF		
L2	0.05	0.10	0.15

GENERIC MARKING DIAGRAM*

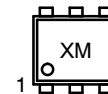

X = Specific Device Code
M = Month Code

*This information is generic. Please refer to device data sheet for actual part marking.
Pb-Free indicator, "G" or microdot "▪", may or may not be present.

RECOMMENDED MOUNTING FOOTPRINT

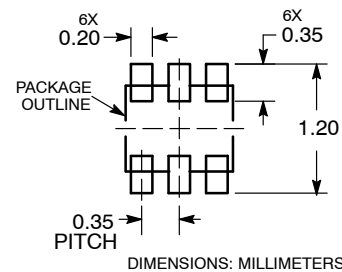

- STYLE 1:**
PIN 1. EMITTER 1
2. BASE 1
3. COLLECTOR 2
4. EMITTER 2
5. BASE 2
6. COLLECTOR 1
- STYLE 2:**
PIN 1. EMITTER 1
2. EMITTER2
3. BASE 2
4. COLLECTOR 2
5. BASE 1
6. COLLECTOR 1
- STYLE 3:**
PIN 1. CATHODE 1
2. CATHODE 1
3. ANODE/ANODE 2
4. CATHODE 2
5. CATHODE 2
6. ANODE/ANODE 1
- STYLE 4:**
PIN 1. COLLECTOR
2. COLLECTOR
3. BASE
4. EMITTER
5. COLLECTOR
6. COLLECTOR
- STYLE 5:**
PIN 1. CATHODE
2. CATHODE
3. ANODE
4. ANODE
5. CATHODE
6. CATHODE
- STYLE 6:**
PIN 1. CATHODE
2. ANODE
3. CATHODE
4. CATHODE
5. CATHODE
6. CATHODE
- STYLE 7:**
PIN 1. CATHODE
2. ANODE
3. CATHODE
4. CATHODE
5. ANODE
6. CATHODE
- STYLE 8:**
PIN 1. DRAIN
2. DRAIN
3. GATE
4. SOURCE3
5. DRAIN
6. DRAIN
- STYLE 9:**
PIN 1. SOURCE 1
2. GATE 1
3. DRAIN 2
4. SOURCE 2
5. GATE 2
6. DRAIN 1
- STYLE 10:**
PIN 1. CATHODE 1
2. N/C
3. CATHODE 2
4. ANODE 2
5. N/C
6. ANODE 1

DOCUMENT NUMBER:	98AON26456D	Electronic versions are uncontrolled except when accessed directly from the Document Repository. Printed versions are uncontrolled except when stamped "CONTROLLED COPY" in red.
DESCRIPTION:	SOT-963, 1X1, 0.35P	PAGE 1 OF 1

ON Semiconductor and are trademarks of Semiconductor Components Industries, LLC dba ON Semiconductor or its subsidiaries in the United States and/or other countries. ON Semiconductor reserves the right to make changes without further notice to any products herein. ON Semiconductor makes no warranty, representation or guarantee regarding the suitability of its products for any particular purpose, nor does ON Semiconductor assume any liability arising out of the application or use of any product or circuit, and specifically disclaims any and all liability, including without limitation special, consequential or incidental damages. ON Semiconductor does not convey any license under its patent rights nor the rights of others.

ON Semiconductor and  are trademarks of Semiconductor Components Industries, LLC dba ON Semiconductor or its subsidiaries in the United States and/or other countries. ON Semiconductor owns the rights to a number of patents, trademarks, copyrights, trade secrets, and other intellectual property. A listing of ON Semiconductor's product/patent coverage may be accessed at www.onsemi.com/site/pdf/Patent-Marking.pdf. ON Semiconductor reserves the right to make changes without further notice to any products herein. ON Semiconductor makes no warranty, representation or guarantee regarding the suitability of its products for any particular purpose, nor does ON Semiconductor assume any liability arising out of the application or use of any product or circuit, and specifically disclaims any and all liability, including without limitation special, consequential or incidental damages. Buyer is responsible for its products and applications using ON Semiconductor products, including compliance with all laws, regulations and safety requirements or standards, regardless of any support or applications information provided by ON Semiconductor. "Typical" parameters which may be provided in ON Semiconductor data sheets and/or specifications can and do vary in different applications and actual performance may vary over time. All operating parameters, including "Typicals" must be validated for each customer application by customer's technical experts. ON Semiconductor does not convey any license under its patent rights nor the rights of others. ON Semiconductor products are not designed, intended, or authorized for use as a critical component in life support systems or any FDA Class 3 medical devices or medical devices with a same or similar classification in a foreign jurisdiction or any devices intended for implantation in the human body. Should Buyer purchase or use ON Semiconductor products for any such unintended or unauthorized application, Buyer shall indemnify and hold ON Semiconductor and its officers, employees, subsidiaries, affiliates, and distributors harmless against all claims, costs, damages, and expenses, and reasonable attorney fees arising out of, directly or indirectly, any claim of personal injury or death associated with such unintended or unauthorized use, even if such claim alleges that ON Semiconductor was negligent regarding the design or manufacture of the part. ON Semiconductor is an Equal Opportunity/Affirmative Action Employer. This literature is subject to all applicable copyright laws and is not for resale in any manner.

PUBLICATION ORDERING INFORMATION

LITERATURE FULFILLMENT:

Email Requests to: orderlit@onsemi.com

ON Semiconductor Website: www.onsemi.com

TECHNICAL SUPPORT

North American Technical Support:
Voice Mail: 1 800-282-9855 Toll Free USA/Canada
Phone: 011 421 33 790 2910

Europe, Middle East and Africa Technical Support:

Phone: 00421 33 790 2910

For additional information, please contact your local Sales Representative