

NLSV2T244

2-Bit Dual-Supply Non-Inverting Level Translator

The NLSV2T244 is a 2-bit configurable dual-supply voltage level translator. The input A_n and output B_n ports are designed to track two different power supply rails, V_{CCA} and V_{CCB} respectively. Both supply rails are configurable from 0.9 V to 4.5 V allowing universal low-voltage translation from the input A_n to the output B_n port.

Features

- Wide V_{CCA} and V_{CCB} Operating Range: 0.9 V to 4.5 V
- High-Speed w/ Balanced Propagation Delay
- Inputs and Outputs have OVT Protection to 4.5 V
- Non-preferential V_{CCA} and V_{CCB} Sequencing
- Outputs at 3-State until Active V_{CC} is Reached
- Power-Off Protection
- Outputs Switch to 3-State with V_{CCB} at GND
- Small Packaging: UDFN8, SO-8, Micro8
- These Devices are Pb-Free, Halogen Free/BFR Free and are RoHS Compliant

Typical Applications

- Mobile Phones, PDAs, Other Portable Devices

Important Information

- ESD Protection for All Pins:
HBM (Human Body Model) > 5000 V



ON Semiconductor®

www.onsemi.com

MARKING DIAGRAMS



UDFN8
MU SUFFIX
CASE 517AJ

UP = Specific Device Code
M = Date Code
▪ = Pb-Free Package

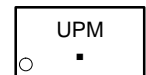

SO-8
D SUFFIX
CASE 751

A = Assembly Location
L = Wafer Lot
Y = Year
W = Work Week
▪ = Pb-Free Package

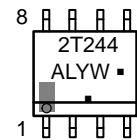

Micro8
DM SUFFIX
CASE 846A

A = Assembly Location
Y = Year
W = Work Week
▪ = Pb-Free Package

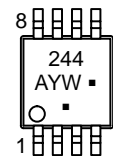

ORDERING INFORMATION

Device	Package	Shipping†
NLSV2T244MUTAG	UDFN8 (Pb-Free)	3000 / Tape & Reel
NLSV2T244DR2G	SO-8 (Pb-Free)	2500 / Tape & Reel
NLSV2T244DMR2G	Micro8 (Pb-Free)	4000 / Tape & Reel

†For information on tape and reel specifications, including part orientation and tape sizes, please refer to our Tape and Reel Packaging Specification Brochure, BRD8011/D.

NLSV2T244

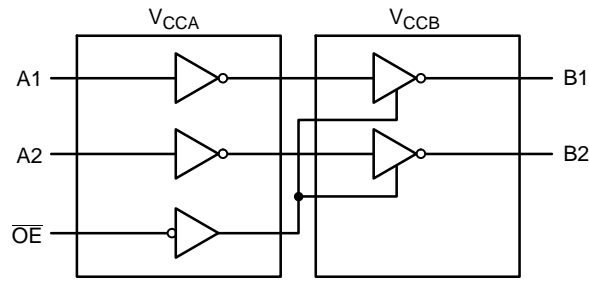
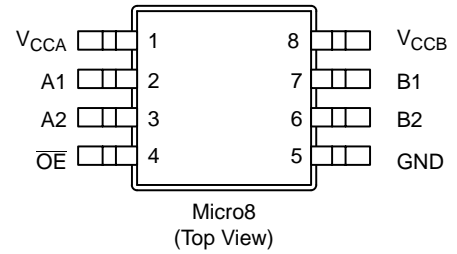
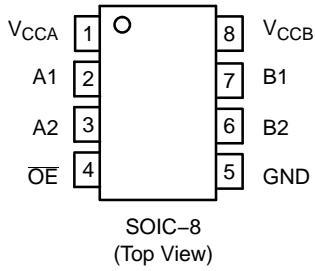
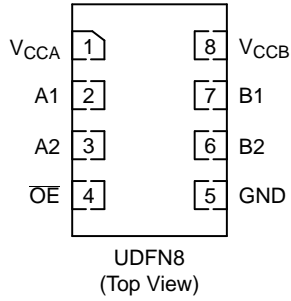

Figure 1. Logic Diagram

PIN ASSIGNMENTS



PIN ASSIGNMENT

PIN	FUNCTION
V _{CCA}	Input Port DC Power Supply
V _{CCB}	Output Port DC Power Supply
GND	Ground
A _n	Input Port
B _n	Output Port
OE	Output Enable

TRUTH TABLE

Inputs		Outputs
OE	A _n	B _n
L	L	L
L	H	H
H	X	3-State

NLSV2T244

MAXIMUM RATINGS

Symbol	Rating	Value	Condition	Unit
V_{CCA}, V_{CCB}	DC Supply Voltage	-0.5 to +5.5		V
V_I	DC Input Voltage A_n	-0.5 to +5.5		V
V_C	Control Input \overline{OE}	-0.5 to +5.5		V
V_O	DC Output Voltage (Power Down) B_n	-0.5 to +5.5	$V_{CCA} = V_{CCB} = 0$	V
	(Active Mode) B_n	-0.5 to +5.5		V
	(Tri-State Mode) B_n	-0.5 to +5.5		V
I_{IK}	DC Input Diode Current	-20	$V_I < \text{GND}$	mA
I_{OK}	DC Output Diode Current	-50	$V_O < \text{GND}$	mA
I_O	DC Output Source/Sink Current	± 50		mA
I_{CCA}, I_{CCB}	DC Supply Current Per Supply Pin	± 100		mA
I_{GND}	DC Ground Current per Ground Pin	± 100		mA
T_{STG}	Storage Temperature	-65 to +150		$^{\circ}\text{C}$

Stresses exceeding those listed in the Maximum Ratings table may damage the device. If any of these limits are exceeded, device functionality should not be assumed, damage may occur and reliability may be affected.

RECOMMENDED OPERATING CONDITIONS

Symbol	Parameter	Min	Max	Unit
V_{CCA}, V_{CCB}	Positive DC Supply Voltage	0.9	4.5	V
V_I	Bus Input Voltage	GND	4.5	V
V_C	Control Input \overline{OE}	GND	4.5	V
V_{IO}	Bus Output Voltage (Power Down Mode) B_n	GND	4.5	V
	(Active Mode) B_n	GND	V_{CCB}	V
	(Tri-State Mode) B_n	GND	4.5	V
T_A	Operating Temperature Range	-40	+85	$^{\circ}\text{C}$
$\Delta t / \Delta V$	Input Transition Rise or Rate V_I , from 30% to 70% of V_{CC} ; $V_{CC} = 3.3 \text{ V} \pm 0.3 \text{ V}$	0	10	nS

Functional operation above the stresses listed in the Recommended Operating Ranges is not implied. Extended exposure to stresses beyond the Recommended Operating Ranges limits may affect device reliability.

NLSV2T244

DC ELECTRICAL CHARACTERISTICS

Symbol	Parameter	Test Conditions	V _{CCA} (V)	V _{CCB} (V)	-40°C to +85°C		Unit
					Min	Max	
V _{IH}	Input HIGH Voltage (An, OE)		3.6 – 4.5	0.9 – 4.5	2.2	–	V
			2.7 – 3.6		2.0	–	
			2.3 – 2.7		1.6	–	
			1.4 – 2.3		0.65 * V _{CCA}	–	
			0.9 – 1.4		0.9 * V _{CCA}	–	
V _{IL}	Input LOW Voltage (An, OE)		3.6 – 4.5	0.9 – 4.5	–	0.8	V
			2.7 – 3.6		–	0.8	
			2.3 – 2.7		–	0.7	
			1.4 – 2.3		–	0.35 * V _{CCA}	
			0.9 – 1.4		–	0.1 * V _{CCA}	
V _{OH}	Output HIGH Voltage	I _{OH} = -100 μA; V _I = V _{IH}	0.9 – 4.5	0.9 – 4.5	V _{CCB} - 0.2	–	V
		I _{OH} = -0.5 mA; V _I = V _{IH}	0.9	0.9	0.75 * V _{CCB}	–	
		I _{OH} = -2 mA; V _I = V _{IH}	1.4	1.4	1.05	–	
		I _{OH} = -6 mA; V _I = V _{IH}	1.65	1.65	1.25	–	
			2.3	2.3	2.0	–	
		I _{OH} = -12 mA; V _I = V _{IH}	2.3	2.3	1.8	–	
			2.7	2.7	2.2	–	
		I _{OH} = -18 mA; V _I = V _{IH}	2.3	2.3	1.7	–	
3.0	3.0		2.4	–			
V _{OL}	Output LOW Voltage	I _{OL} = 100 μA; V _I = V _{IL}	0.9 – 4.5	0.9 – 4.5	–	0.2	V
		I _{OL} = 0.5 mA; V _I = V _{IL}	1.1	1.1	–	0.3	
		I _{OL} = 2 mA; V _I = V _{IL}	1.4	1.4	–	0.35	
		I _{OL} = 6 mA; V _I = V _{IL}	1.65	1.65	–	0.3	
			2.3	2.3	–	0.4	
		I _{OL} = 12 mA; V _I = V _{IL}	2.7	2.7	–	0.4	
			2.3	2.3	–	0.6	
		I _{OL} = 18 mA; V _I = V _{IL}	3.0	3.0	–	0.4	
3.0	3.0		–	0.55			
I _I	Input Leakage Current	V _I = V _{CCA} or GND	0.9 – 4.5	0.9 – 4.5	-1.0	1.0	μA
I _{OFF}	Power-Off Leakage Current	OE = 0 V	0 0.9 – 4.5	0.9 – 4.5 0	-1.0 -1.0	1.0 1.0	μA
I _{CCA}	Quiescent Supply Current	V _I = V _{CCA} or GND; I _O = 0, V _{CCA} = V _{CCB}	0.9 – 4.5	0.9 – 4.5	–	1.0	μA
I _{CCB}	Quiescent Supply Current	V _I = V _{CCA} or GND; I _O = 0, V _{CCA} = V _{CCB}	0.9 – 4.5	0.9 – 4.5	–	1.0	μA
I _{CCA} + I _{CCB}	Quiescent Supply Current	V _I = V _{CCA} or GND; I _O = 0, V _{CCA} = V _{CCB}	0.9 – 4.5	0.9 – 4.5	–	2.0	μA
ΔI _{CCA}	Increase in I _{CC} per Input Voltage, Other Inputs at V _{CCA} or GND	V _I = V _{CCA} - 0.6 V; V _I = V _{CCA} or GND	4.5	4.5	–	10	μA
			3.6	3.6	–	5.0	
ΔI _{CCB}	Increase in I _{CC} per Input Voltage, Other Inputs at V _{CCA} or GND	V _I = V _{CCA} - 0.6 V; V _I = V _{CCA} or GND	4.5	4.5	–	10	μA
			3.6	3.6	–	5.0	
I _{OZ}	I/O Tri-State Output Leakage Current	T _A = 25°C, OE = 0 V	0.9 – 4.5	0.9 – 4.5	-1.0	1.0	μA

Product parametric performance is indicated in the Electrical Characteristics for the listed test conditions, unless otherwise noted. Product performance may not be indicated by the Electrical Characteristics if operated under different conditions.

NLSV2T244

TOTAL STATIC POWER CONSUMPTION ($I_{CCA} + I_{CCB}$)

V_{CCA} (V)	-40°C to +85°C										Unit
	V_{CCB} (V)										
	4.5		3.3		2.8		1.8		0.9		
	Min	Max	Min	Max	Min	Max	Min	Max	Min	Max	
4.5		2		2		2		2		< 1.5	μ A
3.3		2		2		2		2		< 1.5	μ A
2.8		< 2		< 1		< 1		< 0.5		< 0.5	μ A
1.8		< 1		< 1		< 0.5		< 0.5		< 0.5	μ A
0.9		< 0.5		< 0.5		< 0.5		< 0.5		< 0.5	μ A

NOTE: Connect ground before applying supply voltage V_{CCA} or V_{CCB} . This device is designed with the feature that the power-up sequence of V_{CCA} and V_{CCB} will not damage the IC.

AC ELECTRICAL CHARACTERISTICS

Symbol	Parameter	V_{CCA} (V)	-40°C to +85°C										Unit
			V_{CCB} (V)										
			4.5		3.3		2.8		1.8		1.2		
			Min	Max	Min	Max	Min	Max	Min	Max	Min	Max	
t_{PLH} , t_{PHL} (Note 1)	Propagation Delay, A_n to B_n	4.5		1.6		1.8		2.0		2.1		2.3	nS
		3.3		1.7		1.9		2.1		2.3		2.6	
		2.8		1.9		2.1		2.3		2.5		2.8	
		1.8		2.1		2.4		2.5		2.7		3.0	
		1.2		2.4		2.7		2.8		3.0		3.3	
t_{PZH} , t_{PZL} (Note 1)	Output Enable, \overline{OE} to B_n	4.5		2.6		3.8		4.0		4.1		4.3	nS
		3.3		3.7		3.9		4.1		4.3		4.6	
		2.5		3.9		4.1		4.3		4.5		4.8	
		1.8		4.1		4.4		4.5		4.7		5.0	
		1.2		4.4		4.7		4.8		5.0		5.3	
t_{PHZ} , t_{PLZ} (Note 1)	Output Disable, \overline{OE} to B_n	4.5		2.6		3.8		4.0		4.1		4.3	nS
		3.3		3.7		3.9		4.1		4.3		4.6	
		2.5		3.9		4.1		4.3		4.5		4.8	
		1.8		4.1		4.4		4.5		4.7		5.0	
		1.2		4.4		4.7		4.8		5.0		5.3	
t_{OSHL} , t_{OSLH} (Note 1)	Output to Output Skew, Time	4.5		0.15		0.15		0.15		0.15		0.15	nS
		3.3		0.15		0.15		0.15		0.15		0.15	
		2.5		0.15		0.15		0.15		0.15		0.15	
		1.8		0.15		0.15		0.15		0.15		0.15	
		1.2		0.15		0.15		0.15		0.15		0.15	

1. Propagation delays defined per Figure 2.

CAPACITANCE

Symbol	Parameter	Test Conditions	Typ (Note 2)	Unit
C_{IN}	Control Pin Input Capacitance	$V_{CCA} = V_{CCB} = 3.3$ V, $V_I = 0$ V or $V_{CCA/B}$	3.5	pF
$C_{I/O}$	I/O Pin Input Capacitance	$V_{CCA} = V_{CCB} = 3.3$ V, $V_I = 0$ V or $V_{CCA/B}$	5.0	pF
C_{PD}	Power Dissipation Capacitance	$V_{CCA} = V_{CCB} = 3.3$ V, $V_I = 0$ V or V_{CCA} , $f = 10$ MHz	20	pF

2. Typical values are at $T_A = +25^\circ\text{C}$.

3. C_{PD} is defined as the value of the IC's equivalent capacitance from which the operating current can be calculated from:
 $I_{CC(\text{operating})} \cong C_{PD} \times V_{CC} \times f_{IN} \times N_{SW}$ where $I_{CC} = I_{CCA} + I_{CCB}$ and N_{SW} = total number of outputs switching.

NLSV2T244

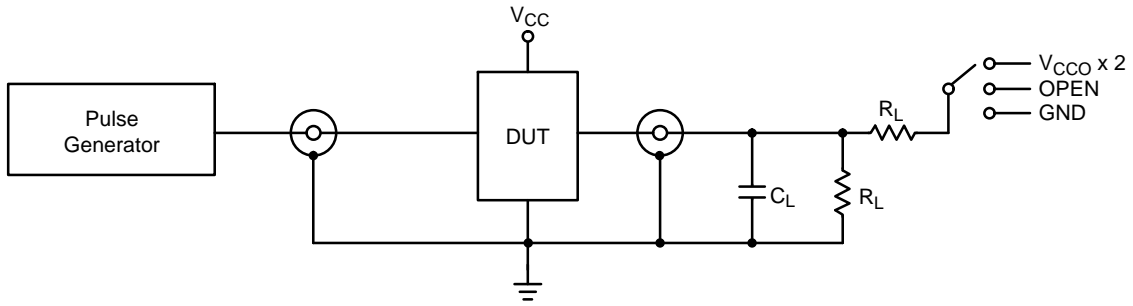
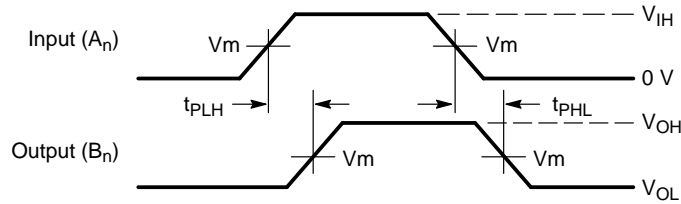

Figure 2. AC (Propagation Delay) Test Circuit

Test	Switch
t_{PLH} , t_{PHL}	OPEN
t_{PLZ} , t_{PZL}	$V_{CCO} \times 2$
t_{PHZ} , t_{PZH}	GND

$C_L = 15 \text{ pF}$ or equivalent (includes probe and jig capacitance)
 $R_L = 2 \text{ k}\Omega$ or equivalent
 Z_{OUT} of pulse generator = 50Ω



Waveform 1 - Propagation Delays

$t_R = t_F = 2.0 \text{ ns}$, 10% to 90%; $f = 1 \text{ MHz}$; $t_W = 500 \text{ ns}$

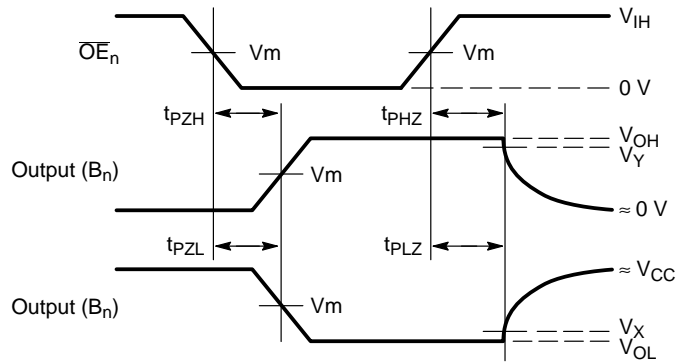

Waveform 2 - Output Enable and Disable Times

$t_R = t_F = 2.0 \text{ ns}$, 10% to 90%; $f = 1 \text{ MHz}$; $t_W = 500 \text{ ns}$

Figure 3. AC (Propagation Delay) Test Circuit Waveforms

Symbol	V_{CC}				
	3.0 V - 4.5 V	2.3 V - 2.7 V	1.65 V - 1.95 V	1.4 V - 1.6 V	0.9 V - 1.3 V
V_{mA}	$V_{CCA}/2$	$V_{CCA}/2$	$V_{CCA}/2$	$V_{CCA}/2$	$V_{CCA}/2$
V_{mB}	$V_{CCB}/2$	$V_{CCB}/2$	$V_{CCB}/2$	$V_{CCB}/2$	$V_{CCB}/2$
V_X	$V_{OL} \times 0.1$	$V_{OL} \times 0.1$	$V_{OL} \times 0.1$	$V_{OL} \times 0.1$	$V_{OL} \times 0.1$
V_Y	$V_{OH} \times 0.9$	$V_{OH} \times 0.9$	$V_{OH} \times 0.9$	$V_{OH} \times 0.9$	$V_{OH} \times 0.9$

MECHANICAL CASE OUTLINE

PACKAGE DIMENSIONS

ON Semiconductor®



SCALE 4:1

UDFN8 1.8x1.2, 0.4P
CASE 517AJ-01
ISSUE O

DATE 08 NOV 2006

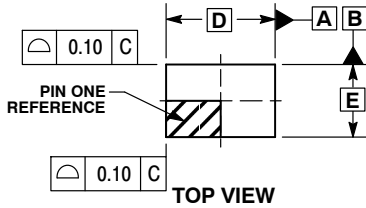

TOP VIEW

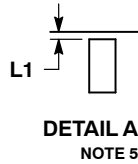

DETAIL A
NOTE 5

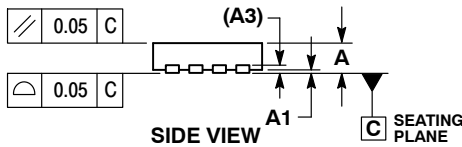

SIDE VIEW

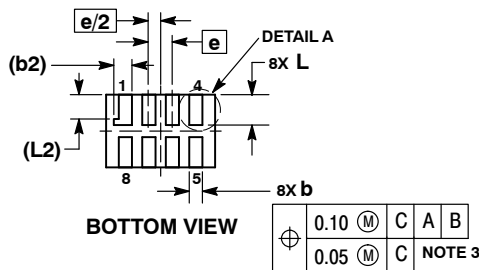

BOTTOM VIEW

⊕	0.10	(M)	C	A	B
	0.05	(M)	C		

NOTE 3

NOTES:

1. DIMENSIONING AND TOLERANCING PER ASME Y14.5M, 1994.
2. CONTROLLING DIMENSION: MILLIMETERS.
3. DIMENSION b APPLIES TO PLATED TERMINAL AND IS MEASURED BETWEEN 0.15 AND 0.30 mm FROM TERMINAL TIP.
4. MOLD FLASH ALLOWED ON TERMINALS ALONG EDGE OF PACKAGE. FLASH MAY NOT EXCEED 0.03 ONTO BOTTOM SURFACE OF TERMINALS.
5. DETAIL A SHOWS OPTIONAL CONSTRUCTION FOR TERMINALS.

DIM	MILLIMETERS	
	MIN	MAX
A	0.45	0.55
A1	0.00	0.05
A3	0.127	REF
b	0.15	0.25
b2	0.30	REF
D	1.80	BSC
E	1.20	BSC
e	0.40	BSC
L	0.45	0.55
L1	0.00	0.03
L2	0.40	REF

GENERIC MARKING DIAGRAM*

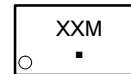

- XX = Specific Device Code
- M = Date Code
- = Pb-Free Package

MOUNTING FOOTPRINT
SOLDERMASK DEFINED

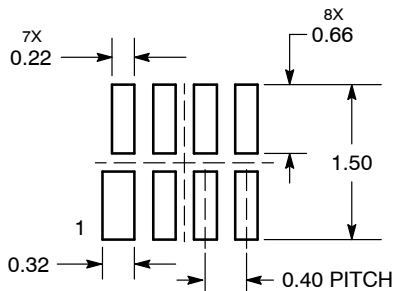

DIMENSIONS: MILLIMETERS

*This information is generic. Please refer to device data sheet for actual part marking. Pb-Free indicator, "G" or microdot "▪", may or may not be present.

DOCUMENT NUMBER:	98AON23417D	Electronic versions are uncontrolled except when accessed directly from the Document Repository. Printed versions are uncontrolled except when stamped "CONTROLLED COPY" in red.
DESCRIPTION:	UDFN8 1.8X1.2, 0.4P	PAGE 1 OF 1

ON Semiconductor and ON are trademarks of Semiconductor Components Industries, LLC dba ON Semiconductor or its subsidiaries in the United States and/or other countries. ON Semiconductor reserves the right to make changes without further notice to any products herein. ON Semiconductor makes no warranty, representation or guarantee regarding the suitability of its products for any particular purpose, nor does ON Semiconductor assume any liability arising out of the application or use of any product or circuit, and specifically disclaims any and all liability, including without limitation special, consequential or incidental damages. ON Semiconductor does not convey any license under its patent rights nor the rights of others.

MECHANICAL CASE OUTLINE

PACKAGE DIMENSIONS

ON Semiconductor®



SCALE 1:1

SOIC-8 NB
CASE 751-07
ISSUE AK

DATE 16 FEB 2011

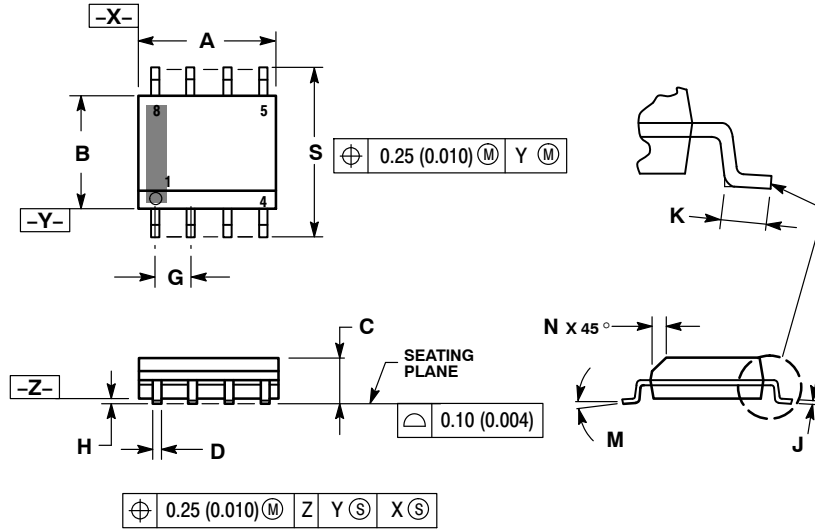

- NOTES:
1. DIMENSIONING AND TOLERANCING PER ANSI Y14.5M, 1982.
 2. CONTROLLING DIMENSION: MILLIMETER.
 3. DIMENSION A AND B DO NOT INCLUDE MOLD PROTRUSION.
 4. MAXIMUM MOLD PROTRUSION 0.15 (0.006) PER SIDE.
 5. DIMENSION D DOES NOT INCLUDE DAMBAR PROTRUSION. ALLOWABLE DAMBAR PROTRUSION SHALL BE 0.127 (0.005) TOTAL IN EXCESS OF THE D DIMENSION AT MAXIMUM MATERIAL CONDITION.
 6. 751-01 THRU 751-06 ARE OBSOLETE. NEW STANDARD IS 751-07.

DIM	MILLIMETERS		INCHES	
	MIN	MAX	MIN	MAX
A	4.80	5.00	0.189	0.197
B	3.80	4.00	0.150	0.157
C	1.35	1.75	0.053	0.069
D	0.33	0.51	0.013	0.020
G	1.27 BSC		0.050 BSC	
H	0.10	0.25	0.004	0.010
J	0.19	0.25	0.007	0.010
K	0.40	1.27	0.016	0.050
M	0°	8°	0°	8°
N	0.25	0.50	0.010	0.020
S	5.80	6.20	0.228	0.244

GENERIC MARKING DIAGRAM*

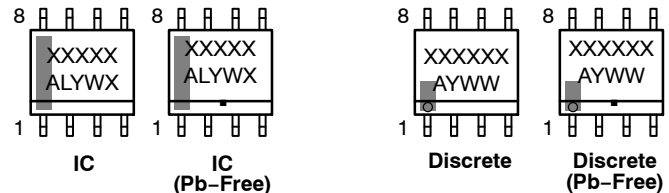
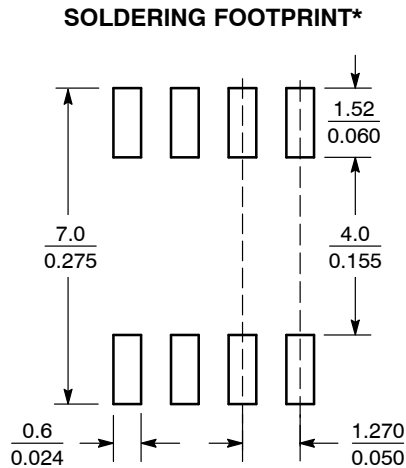

XXXXX = Specific Device Code
A = Assembly Location
L = Wafer Lot
Y = Year
W = Work Week
■ = Pb-Free Package

XXXXXX = Specific Device Code
A = Assembly Location
Y = Year
WW = Work Week
■ = Pb-Free Package

*This information is generic. Please refer to device data sheet for actual part marking. Pb-Free indicator, "G" or microdot "•", may or may not be present. Some products may not follow the Generic Marking.

*For additional information on our Pb-Free strategy and soldering details, please download the ON Semiconductor Soldering and Mounting Techniques Reference Manual, SOLDERM/D.

STYLES ON PAGE 2

DOCUMENT NUMBER:	98ASB42564B	Electronic versions are uncontrolled except when accessed directly from the Document Repository. Printed versions are uncontrolled except when stamped "CONTROLLED COPY" in red.
DESCRIPTION:	SOIC-8 NB	PAGE 1 OF 2

ON Semiconductor and ON are trademarks of Semiconductor Components Industries, LLC dba ON Semiconductor or its subsidiaries in the United States and/or other countries. ON Semiconductor reserves the right to make changes without further notice to any products herein. ON Semiconductor makes no warranty, representation or guarantee regarding the suitability of its products for any particular purpose, nor does ON Semiconductor assume any liability arising out of the application or use of any product or circuit, and specifically disclaims any and all liability, including without limitation special, consequential or incidental damages. ON Semiconductor does not convey any license under its patent rights nor the rights of others.

SOIC-8 NB
CASE 751-07
ISSUE AK

DATE 16 FEB 2011

- | | | | |
|--|---|---|---|
| <p>STYLE 1:
 PIN 1. EMITTER
 2. COLLECTOR
 3. COLLECTOR
 4. EMITTER
 5. EMITTER
 6. BASE
 7. BASE
 8. EMITTER</p> | <p>STYLE 2:
 PIN 1. COLLECTOR, DIE, #1
 2. COLLECTOR, #1
 3. COLLECTOR, #2
 4. COLLECTOR, #2
 5. BASE, #2
 6. EMITTER, #2
 7. BASE, #1
 8. EMITTER, #1</p> | <p>STYLE 3:
 PIN 1. DRAIN, DIE #1
 2. DRAIN, #1
 3. DRAIN, #2
 4. DRAIN, #2
 5. GATE, #2
 6. SOURCE, #2
 7. GATE, #1
 8. SOURCE, #1</p> | <p>STYLE 4:
 PIN 1. ANODE
 2. ANODE
 3. ANODE
 4. ANODE
 5. ANODE
 6. ANODE
 7. ANODE
 8. COMMON CATHODE</p> |
| <p>STYLE 5:
 PIN 1. DRAIN
 2. DRAIN
 3. DRAIN
 4. DRAIN
 5. GATE
 6. GATE
 7. SOURCE
 8. SOURCE</p> | <p>STYLE 6:
 PIN 1. SOURCE
 2. DRAIN
 3. DRAIN
 4. SOURCE
 5. SOURCE
 6. GATE
 7. GATE
 8. SOURCE</p> | <p>STYLE 7:
 PIN 1. INPUT
 2. EXTERNAL BYPASS
 3. THIRD STAGE SOURCE
 4. GROUND
 5. DRAIN
 6. GATE 3
 7. SECOND STAGE Vd
 8. FIRST STAGE Vd</p> | <p>STYLE 8:
 PIN 1. COLLECTOR, DIE #1
 2. BASE, #1
 3. BASE, #2
 4. COLLECTOR, #2
 5. COLLECTOR, #2
 6. EMITTER, #2
 7. EMITTER, #1
 8. COLLECTOR, #1</p> |
| <p>STYLE 9:
 PIN 1. EMITTER, COMMON
 2. COLLECTOR, DIE #1
 3. COLLECTOR, DIE #2
 4. EMITTER, COMMON
 5. EMITTER, COMMON
 6. BASE, DIE #2
 7. BASE, DIE #1
 8. EMITTER, COMMON</p> | <p>STYLE 10:
 PIN 1. GROUND
 2. BIAS 1
 3. OUTPUT
 4. GROUND
 5. GROUND
 6. BIAS 2
 7. INPUT
 8. GROUND</p> | <p>STYLE 11:
 PIN 1. SOURCE 1
 2. GATE 1
 3. SOURCE 2
 4. GATE 2
 5. DRAIN 2
 6. DRAIN 2
 7. DRAIN 1
 8. DRAIN 1</p> | <p>STYLE 12:
 PIN 1. SOURCE
 2. SOURCE
 3. SOURCE
 4. GATE
 5. DRAIN
 6. DRAIN
 7. DRAIN
 8. DRAIN</p> |
| <p>STYLE 13:
 PIN 1. N.C.
 2. SOURCE
 3. SOURCE
 4. GATE
 5. DRAIN
 6. DRAIN
 7. DRAIN
 8. DRAIN</p> | <p>STYLE 14:
 PIN 1. N-SOURCE
 2. N-GATE
 3. P-SOURCE
 4. P-GATE
 5. P-DRAIN
 6. P-DRAIN
 7. N-DRAIN
 8. N-DRAIN</p> | <p>STYLE 15:
 PIN 1. ANODE 1
 2. ANODE 1
 3. ANODE 1
 4. ANODE 1
 5. CATHODE, COMMON
 6. CATHODE, COMMON
 7. CATHODE, COMMON
 8. CATHODE, COMMON</p> | <p>STYLE 16:
 PIN 1. EMITTER, DIE #1
 2. BASE, DIE #1
 3. EMITTER, DIE #2
 4. BASE, DIE #2
 5. COLLECTOR, DIE #2
 6. COLLECTOR, DIE #2
 7. COLLECTOR, DIE #1
 8. COLLECTOR, DIE #1</p> |
| <p>STYLE 17:
 PIN 1. VCC
 2. V2OUT
 3. V1OUT
 4. TXE
 5. RXE
 6. VEE
 7. GND
 8. ACC</p> | <p>STYLE 18:
 PIN 1. ANODE
 2. ANODE
 3. SOURCE
 4. GATE
 5. DRAIN
 6. DRAIN
 7. CATHODE
 8. CATHODE</p> | <p>STYLE 19:
 PIN 1. SOURCE 1
 2. GATE 1
 3. SOURCE 2
 4. GATE 2
 5. DRAIN 2
 6. MIRROR 2
 7. DRAIN 1
 8. MIRROR 1</p> | <p>STYLE 20:
 PIN 1. SOURCE (N)
 2. GATE (N)
 3. SOURCE (P)
 4. GATE (P)
 5. DRAIN
 6. DRAIN
 7. DRAIN
 8. DRAIN</p> |
| <p>STYLE 21:
 PIN 1. CATHODE 1
 2. CATHODE 2
 3. CATHODE 3
 4. CATHODE 4
 5. CATHODE 5
 6. COMMON ANODE
 7. COMMON ANODE
 8. CATHODE 6</p> | <p>STYLE 22:
 PIN 1. I/O LINE 1
 2. COMMON CATHODE/VCC
 3. COMMON CATHODE/VCC
 4. I/O LINE 3
 5. COMMON ANODE/GND
 6. I/O LINE 4
 7. I/O LINE 5
 8. COMMON ANODE/GND</p> | <p>STYLE 23:
 PIN 1. LINE 1 IN
 2. COMMON ANODE/GND
 3. COMMON ANODE/GND
 4. LINE 2 IN
 5. LINE 2 OUT
 6. COMMON ANODE/GND
 7. COMMON ANODE/GND
 8. LINE 1 OUT</p> | <p>STYLE 24:
 PIN 1. BASE
 2. EMITTER
 3. COLLECTOR/ANODE
 4. COLLECTOR/ANODE
 5. CATHODE
 6. CATHODE
 7. COLLECTOR/ANODE
 8. COLLECTOR/ANODE</p> |
| <p>STYLE 25:
 PIN 1. VIN
 2. N/C
 3. REXT
 4. GND
 5. IOUT
 6. IOUT
 7. IOUT
 8. IOUT</p> | <p>STYLE 26:
 PIN 1. GND
 2. dv/dt
 3. ENABLE
 4. ILIMIT
 5. SOURCE
 6. SOURCE
 7. SOURCE
 8. VCC</p> | <p>STYLE 27:
 PIN 1. ILIMIT
 2. OVLO
 3. UVLO
 4. INPUT+
 5. SOURCE
 6. SOURCE
 7. SOURCE
 8. DRAIN</p> | <p>STYLE 28:
 PIN 1. SW_TO_GND
 2. DASIC OFF
 3. DASIC_SW_DET
 4. GND
 5. V_MON
 6. VBULK
 7. VBULK
 8. VIN</p> |
| <p>STYLE 29:
 PIN 1. BASE, DIE #1
 2. EMITTER, #1
 3. BASE, #2
 4. EMITTER, #2
 5. COLLECTOR, #2
 6. COLLECTOR, #2
 7. COLLECTOR, #1
 8. COLLECTOR, #1</p> | <p>STYLE 30:
 PIN 1. DRAIN 1
 2. DRAIN 1
 3. GATE 2
 4. SOURCE 2
 5. SOURCE 1/DRAIN 2
 6. SOURCE 1/DRAIN 2
 7. SOURCE 1/DRAIN 2
 8. GATE 1</p> | | |

DOCUMENT NUMBER:	98ASB42564B	Electronic versions are uncontrolled except when accessed directly from the Document Repository. Printed versions are uncontrolled except when stamped "CONTROLLED COPY" in red.
DESCRIPTION:	SOIC-8 NB	PAGE 2 OF 2

ON Semiconductor and  are trademarks of Semiconductor Components Industries, LLC dba ON Semiconductor or its subsidiaries in the United States and/or other countries. ON Semiconductor reserves the right to make changes without further notice to any products herein. ON Semiconductor makes no warranty, representation or guarantee regarding the suitability of its products for any particular purpose, nor does ON Semiconductor assume any liability arising out of the application or use of any product or circuit, and specifically disclaims any and all liability, including without limitation special, consequential or incidental damages. ON Semiconductor does not convey any license under its patent rights nor the rights of others.

MECHANICAL CASE OUTLINE

PACKAGE DIMENSIONS

ON Semiconductor®



SCALE 2:1

Micro8 CASE 846A-02 ISSUE K

DATE 16 JUL 2020

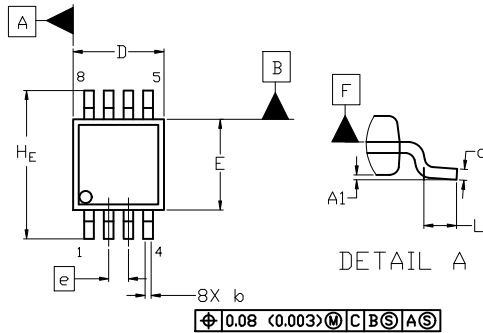

TOP VIEW

NOTE 3

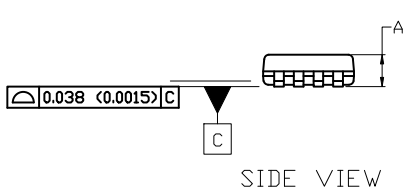

SIDE VIEW

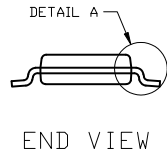

END VIEW

NOTES:

1. DIMENSIONING AND TOLERANCING PER ASME Y14.5M, 2009.
2. CONTROLLING DIMENSION: MILLIMETERS
3. DIMENSION *b* DOES NOT INCLUDE DAMBAR PROTRUSION. ALLOWABLE PROTRUSION SHALL BE 0.10 mm IN EXCESS OF MAXIMUM MATERIAL CONDITION.
4. DIMENSIONS *D* AND *E* DO NOT INCLUDE MOLD FLASH, PROTRUSION OR GATE BURRS. MOLD FLASH, PROTRUSIONS, OR GATE BURRS SHALL NOT EXCEED 0.15 mm PER SIDE. DIMENSION *E* DOES NOT INCLUDE INTERLEAD FLASH OR PROTRUSION. INTERLEAD FLASH OR PROTRUSION SHALL NOT EXCEED 0.25 mm PER SIDE. DIMENSIONS *D* AND *E* ARE DETERMINED AT DATUM *F*.
5. DATUMS *A* AND *B* ARE TO BE DETERMINED AT DATUM *F*.
6. *A1* IS DEFINED AS THE VERTICAL DISTANCE FROM THE SEATING PLANE TO THE LOWEST POINT ON THE PACKAGE BODY.

$\phi 0.08$ (0.003) M C B S A S

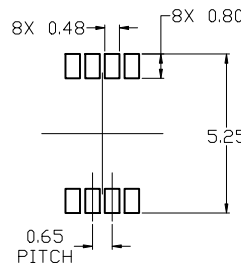

RECOMMENDED MOUNTING FOOTPRINT

DIM	MILLIMETERS		
	MIN.	NOM.	MAX.
A	---	---	1.10
A1	0.05	0.08	0.15
<i>b</i>	0.25	0.33	0.40
<i>c</i>	0.13	0.18	0.23
<i>D</i>	2.90	3.00	3.10
<i>E</i>	2.90	3.00	3.10
<i>e</i>	0.65 BSC		
<i>H_E</i>	4.75	4.90	5.05
<i>L</i>	0.40	0.55	0.70

For additional information on our Pb-Free strategy and soldering details, please download the ON Semiconductor Soldering and Mounting Techniques Reference Manual, SOLDERM/D.

GENERIC MARKING DIAGRAM*

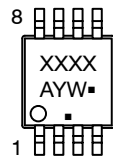

- XXXX = Specific Device Code
- A = Assembly Location
- Y = Year
- W = Work Week
- = Pb-Free Package

(Note: Microdot may be in either location)

*This information is generic. Please refer to device data sheet for actual part marking. Pb-Free indicator, "G" or microdot "▪", may or may not be present. Some products may not follow the Generic Marking.

STYLE 1:

1. SOURCE
2. SOURCE
3. SOURCE
4. GATE
5. DRAIN
6. DRAIN
7. DRAIN
8. DRAIN

STYLE 2:

1. SOURCE 1
2. GATE 1
3. SOURCE 2
4. GATE 2
5. DRAIN 2
6. DRAIN 2
7. DRAIN 1
8. DRAIN 1

STYLE 3:

1. N-SOURCE
2. N-GATE
3. P-SOURCE
4. P-GATE
5. P-DRAIN
6. P-DRAIN
7. N-DRAIN
8. N-DRAIN

DOCUMENT NUMBER:	98ASB14087C	Electronic versions are uncontrolled except when accessed directly from the Document Repository. Printed versions are uncontrolled except when stamped "CONTROLLED COPY" in red.
DESCRIPTION:	MICRO8	PAGE 1 OF 1

ON Semiconductor and ON are trademarks of Semiconductor Components Industries, LLC dba ON Semiconductor or its subsidiaries in the United States and/or other countries. ON Semiconductor reserves the right to make changes without further notice to any products herein. ON Semiconductor makes no warranty, representation or guarantee regarding the suitability of its products for any particular purpose, nor does ON Semiconductor assume any liability arising out of the application or use of any product or circuit, and specifically disclaims any and all liability, including without limitation special, consequential or incidental damages. ON Semiconductor does not convey any license under its patent rights nor the rights of others.

onsemi, **Onsemi**, and other names, marks, and brands are registered and/or common law trademarks of Semiconductor Components Industries, LLC dba "**onsemi**" or its affiliates and/or subsidiaries in the United States and/or other countries. **onsemi** owns the rights to a number of patents, trademarks, copyrights, trade secrets, and other intellectual property. A listing of **onsemi**'s product/patent coverage may be accessed at www.onsemi.com/site/pdf/Patent-Marking.pdf. **onsemi** reserves the right to make changes at any time to any products or information herein, without notice. The information herein is provided "as-is" and **onsemi** makes no warranty, representation or guarantee regarding the accuracy of the information, product features, availability, functionality, or suitability of its products for any particular purpose, nor does **onsemi** assume any liability arising out of the application or use of any product or circuit, and specifically disclaims any and all liability, including without limitation special, consequential or incidental damages. Buyer is responsible for its products and applications using **onsemi** products, including compliance with all laws, regulations and safety requirements or standards, regardless of any support or applications information provided by **onsemi**. "Typical" parameters which may be provided in **onsemi** data sheets and/or specifications can and do vary in different applications and actual performance may vary over time. All operating parameters, including "Typicals" must be validated for each customer application by customer's technical experts. **onsemi** does not convey any license under any of its intellectual property rights nor the rights of others. **onsemi** products are not designed, intended, or authorized for use as a critical component in life support systems or any FDA Class 3 medical devices or medical devices with a same or similar classification in a foreign jurisdiction or any devices intended for implantation in the human body. Should Buyer purchase or use **onsemi** products for any such unintended or unauthorized application, Buyer shall indemnify and hold **onsemi** and its officers, employees, subsidiaries, affiliates, and distributors harmless against all claims, costs, damages, and expenses, and reasonable attorney fees arising out of, directly or indirectly, any claim of personal injury or death associated with such unintended or unauthorized use, even if such claim alleges that **onsemi** was negligent regarding the design or manufacture of the part. **onsemi** is an Equal Opportunity/Affirmative Action Employer. This literature is subject to all applicable copyright laws and is not for resale in any manner.

PUBLICATION ORDERING INFORMATION

LITERATURE FULFILLMENT:

Email Requests to: orderlit@onsemi.com

onsemi Website: www.onsemi.com

TECHNICAL SUPPORT

North American Technical Support:
Voice Mail: 1 800-282-9855 Toll Free USA/Canada
Phone: 011 421 33 790 2910

Europe, Middle East and Africa Technical Support:

Phone: 00421 33 790 2910

For additional information, please contact your local Sales Representative