

2-Input NOR Gate

NL17SZ02

The NL17SZ02 is a single 2-input NOR Gate in tiny footprint packages.

Features

- Designed for 1.65 V to 5.5 V V_{CC} Operation
- 2.4 ns t_{PD} at $V_{CC} = 5$ V (typ)
- Inputs/Outputs Overvoltage Tolerant up to 5.5 V
- I_{OFF} Supports Partial Power Down Protection
- Source/Sink 24 mA at 3.0 V
- Available in SC-88A, SC-74A, SOT-553, SOT-953 and UDFN6 Packages
- Chip Complexity < 100 FETs
- NLV Prefix for Automotive and Other Applications Requiring Unique Site and Control Change Requirements; AEC-Q100 Qualified and PPAP Capable
- These Devices are Pb-Free, Halogen Free/BFR Free and are RoHS Compliant

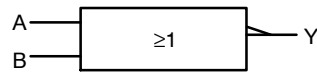

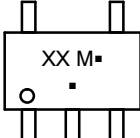

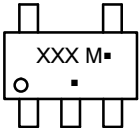

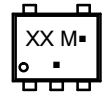

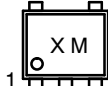





Figure 1. Logic Symbol



ON Semiconductor®

www.onsemi.com

| MARKING DIAGRAMS | | |
|--|------------------------------------|---|
|  | SC-88A DF SUFFIX CASE 419A |  |
|  | SC-74A DBV SUFFIX CASE 318BQ |  |
|  | SOT-553 XV5 SUFFIX CASE 463B |  |
|  | SOT-953 P5 SUFFIX CASE 527AE |  |
|  | UDFN6 1.45 x 1.0 CASE 517AQ |  |
|  | UDFN6 1.0 x 1.0 CASE 517BX |  |

XX = Specific Device Code
 M = Date Code*
 ■ = Pb-Free Package

(Note: Microdot may be in either location)

*Date Code orientation and/or position may vary depending upon manufacturing location.

ORDERING INFORMATION

See detailed ordering, marking and shipping information in the package dimensions section on page 7 of this data sheet.

NL17SZ02

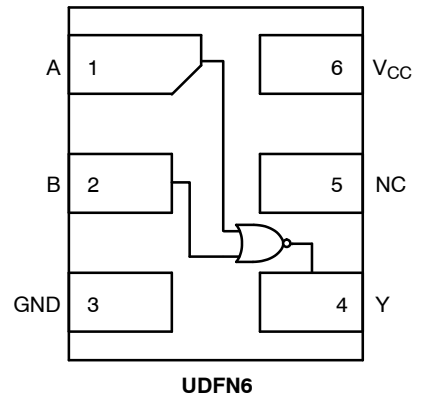
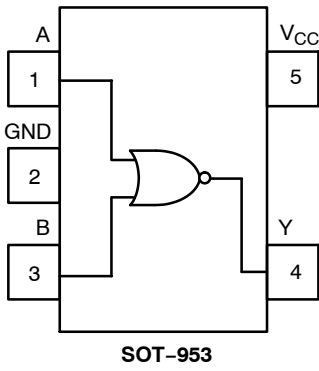
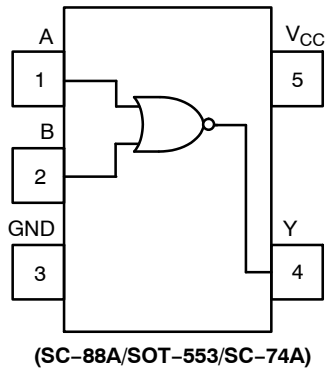

Figure 2. Pinout (Top View)

PIN ASSIGNMENT (SC-88A/SOT-553/SC-74A)

| Pin | Function |
|-----|-----------------|
| 1 | A |
| 2 | B |
| 3 | GND |
| 4 | Y |
| 5 | V _{CC} |

PIN ASSIGNMENT (SOT-953)

| Pin | Function |
|-----|-----------------|
| 1 | A |
| 2 | GND |
| 3 | B |
| 4 | Y |
| 5 | V _{CC} |

PIN ASSIGNMENT (UDFN)

| Pin | Function |
|-----|-----------------|
| 1 | A |
| 2 | B |
| 3 | GND |
| 4 | Y |
| 5 | NC |
| 6 | V _{CC} |

FUNCTION TABLE

| Input | | Output $Y = \overline{A + B}$ |
|-------|---|----------------------------------|
| A | B | Y |
| L | L | H |
| L | H | L |
| H | L | L |
| H | H | L |

NL17SZ02

MAXIMUM RATINGS

| Symbol | Characteristics | Value | Unit |
|-----------------------|---|--|---------------|
| V_{CC} | DC Supply Voltage SC-88A (NLV) SC-74A, SC-88A, SOT-953, SOT-553, UDFN6 | -0.5 to +7.0 -0.5 to +6.5 | V |
| V_{IN} | DC Input Voltage SC-88A (NLV) SC-74A, SC-88A, SOT-953, SOT-553, UDFN6 | -0.5 to +7.0 -0.5 to +6.5 | V |
| V_{OUT} | DC Output Voltage SC-88A (NLV) Active-Mode (High or Low State) Tri-State Mode (Note 1) Power-Down Mode ($V_{CC} = 0$ V) | -0.5 to $V_{CC} + 0.5$ -0.5 to +7.0 -0.5 to +7.0 | V |
| | DC Output Voltage SC-74A, SC-88A, SOT-953, SOT-553, UDFN6 Active-Mode (High or Low State) Tri-State Mode (Note 1) Power-Down Mode ($V_{CC} = 0$ V) | -0.5 to $V_{CC} + 0.5$ -0.5 to +6.5 -0.5 to +6.5 | V |
| I_{IK} | DC Input Diode Current $V_{IN} < GND$ | -50 | mA |
| I_{OK} | DC Output Diode Current $V_{OUT} < GND$ | -50 | mA |
| I_{OUT} | DC Output Source/Sink Current | ± 50 | mA |
| I_{CC} or I_{GND} | DC Supply Current per Supply Pin or Ground Pin | ± 100 | mA |
| T_{STG} | Storage Temperature Range | -65 to +150 | $^{\circ}C$ |
| T_L | Lead Temperature, 1 mm from Case for 10 secs | 260 | $^{\circ}C$ |
| T_J | Junction Temperature Under Bias | +150 | $^{\circ}C$ |
| θ_{JA} | Thermal Resistance (Note 2) SC-88A SC-74A SOT-553 SOT-953 UDFN6 | 377 320 324 254 154 | $^{\circ}C/W$ |
| P_D | Power Dissipation in Still Air SC-88A SC-74A SOT-553 SOT-953 UDFN6 | 332 390 386 491 812 | mW |
| MSL | Moisture Sensitivity | Level 1 | - |
| F_R | Flammability Rating Oxygen Index: 28 to 34 | UL 94 V-0 @ 0.125 in | - |
| V_{ESD} | ESD Withstand Voltage (Note 3) Human Body Model Charged Device Model | 2000 1000 | V |
| $I_{Latchup}$ | Latchup Performance (Note 4) | ± 100 | mA |

Stresses exceeding those listed in the Maximum Ratings table may damage the device. If any of these limits are exceeded, device functionality should not be assumed, damage may occur and reliability may be affected.

1. Applicable to devices with outputs that may be tri-stated.
2. Measured with minimum pad spacing on an FR4 board, using 10mm-by-1inch, 2 ounce copper trace no air flow per JESD51-7.
3. HBM tested to ANSI/ESDA/JEDEC JS-001-2017. CDM tested to EIA/JESD22-C101-F. JEDEC recommends that ESD qualification to EIA/JESD22-A115-A (Machine Model) be discontinued per JEDEC/JEP172A.
4. Tested to EIA/JESD78 Class II.

NL17SZ02

RECOMMENDED OPERATING CONDITIONS

| Symbol | Characteristics | Min | Max | Unit | |
|---------------------------------|---|------------------------------------|-----------------|------|------|
| V _{CC} | Positive DC Supply Voltage | 1.65 | 5.5 | V | |
| V _{IN} | DC Input Voltage | 0 | 5.5 | V | |
| V _{OUT} | DC Output Voltage | 0 | V _{CC} | V | |
| | Active-Mode (High or Low State) | 0 | 5.5 | | |
| | Tri-State Mode (Note 1) Power-Down Mode (V _{CC} = 0 V) | 0 | 5.5 | | |
| T _A | Operating Temperature Range | -55 | +125 | °C | |
| t _r , t _f | Input Rise and Fall Time SC-88A (NLV) | V _{CC} = 3.0 V to 3.6 V | 0 | 100 | ns/V |
| | | V _{CC} = 4.5 V to 5.5 V | 0 | 20 | |
| | Input Rise and Fall Time (SC-74A, SC-88A, SOT-953, SOT-553, UDFN6) | V _{CC} = 1.65 V to 1.95 V | 0 | 20 | |
| | | V _{CC} = 2.3 V to 2.7 V | 0 | 20 | |
| | V _{CC} = 3.0 V to 3.6 V | 0 | 10 | | |
| | V _{CC} = 4.5 V to 5.5 V | 0 | 5 | | |

Functional operation above the stresses listed in the Recommended Operating Ranges is not implied. Extended exposure to stresses beyond the Recommended Operating Ranges limits may affect device reliability.

DC ELECTRICAL CHARACTERISTICS

| Symbol | Parameter | Condition | V _{CC} (V) | T _A = 25°C | | | -55°C ≤ T _A ≤ 125°C | | Units |
|------------------|---------------------------|---|------------------------|-----------------------|-----------------|----------------------|--------------------------------|----------------------|-------|
| | | | | Min | Typ | Max | Min | Max | |
| V _{IH} | High-Level Input Voltage | | 1.65 to 1.95 | 0.65 V _{CC} | - | - | 0.65 V _{CC} | - | V |
| | | | 2.3 to 5.5 | 0.70 V _{CC} | - | - | 0.70 V _{CC} | - | |
| V _{IL} | Low-Level Input Voltage | | 1.65 to 1.95 | - | - | 0.35 V _{CC} | - | 0.35 V _{CC} | V |
| | | | 2.3 to 5.5 | - | - | 0.30 V _{CC} | - | 0.30 V _{CC} | |
| V _{OH} | High-Level Output Voltage | V _{IN} = V _{IH} or V _{IL} I _{OH} = -100 μA I _{OH} = -4 mA I _{OH} = -8 mA I _{OH} = -12 mA I _{OH} = -16 mA I _{OH} = -24 mA I _{OH} = -32 mA | 1.65 to 5.5 | V _{CC} - 0.1 | V _{CC} | - | V _{CC} - 0.1 | - | V |
| | | | 1.65 | 1.29 | 1.4 | - | 1.29 | - | |
| | | | 2.3 | 1.9 | 2.1 | - | 1.9 | - | |
| | | | 2.7 | 2.2 | 2.4 | - | 2.2 | - | |
| | | | 3.0 | 2.4 | 2.7 | - | 2.4 | - | |
| | | | 3.0 | 2.3 | 2.5 | - | 2.3 | - | |
| | | | 4.5 | 3.8 | 4.0 | - | 3.8 | - | |
| V _{OL} | Low-Level Output Voltage | V _{IN} = V _{IH} or V _{IL} I _{OL} = 100 μA I _{OL} = 4 mA I _{OL} = 8 mA I _{OL} = 12 mA I _{OL} = 16 mA I _{OL} = 24 mA I _{OL} = 32 mA | 1.65 to 5.5 | - | - | 0.1 | - | 0.1 | V |
| | | | 1.65 | - | 0.08 | 0.24 | - | 0.24 | |
| | | | 2.3 | - | 0.2 | 0.3 | - | 0.3 | |
| | | | 2.7 | - | 0.22 | 0.4 | - | 0.4 | |
| | | | 3.0 | - | 0.28 | 0.4 | - | 0.4 | |
| | | | 3.0 | - | 0.38 | 0.55 | - | 0.55 | |
| | | | 4.5 | - | 0.42 | 0.55 | - | 0.55 | |
| I _{IN} | Input Leakage Current | V _{IN} = 5.5 V or GND | 1.65 to 5.5 | - | - | ±0.1 | - | ±1.0 | μA |
| I _{OFF} | Power Off Leakage Current | V _{IN} = 5.5 V or V _{OUT} = 5.5 V | 0 | - | - | 1.0 | - | 10 | μA |
| I _{CC} | Quiescent Supply Current | V _{IN} = V _{CC} or GND | 5.5 | - | - | 1.0 | - | 10 | μA |

Product parametric performance is indicated in the Electrical Characteristics for the listed test conditions, unless otherwise noted. Product performance may not be indicated by the Electrical Characteristics if operated under different conditions.

NL17SZ02

AC ELECTRICAL CHARACTERISTICS

| Symbol | Parameter | Condition | V _{CC} (V) | T _A = 25°C | | | -55°C ≤ T _A ≤ 125°C | | Units |
|--|--|--|------------------------|-----------------------|-----|-----|--------------------------------|-----|-------|
| | | | | Min | Typ | Max | Min | Max | |
| t _{PLH} , t _{PHL} | Propagation Delay, (A or B) to Y (Figures 3 and 4) | R _L = 1 MΩ, C _L = 15 pF | 1.65 to 1.95 | - | 5.3 | 11 | - | 12 | ns |
| | | R _L = 1 MΩ, C _L = 15 pF | 2.3 to 2.7 | - | 2.9 | 6.5 | - | 7.0 | |
| | | R _L = 1 MΩ, C _L = 15 pF | 3.0 to 3.6 | - | 2.3 | 4.5 | - | 4.7 | |
| | | R _L = 500 Ω, C _L = 50 pF | | - | 2.9 | 5.0 | - | 5.2 | |
| | | R _L = 1 MΩ, C _L = 15 pF | 4.5 to 5.5 | - | 1.9 | 3.9 | - | 4.1 | |
| | | R _L = 500 Ω, C _L = 50 pF | | - | 2.4 | 4.3 | - | 4.5 | |

CAPACITIVE CHARACTERISTICS

| Symbol | Parameter | Condition | Typical | Units |
|------------------|---|---|---------|-------|
| C _{IN} | Input Capacitance | V _{CC} = 5.5 V, V _{IN} = 0 V or V _{CC} | 2.5 | pF |
| C _{OUT} | Output Capacitance | V _{CC} = 5.5 V, V _{IN} = 0 V or V _{CC} | 2.5 | pF |
| C _{PD} | Power Dissipation Capacitance (Note 5) | 10 MHz, V _{CC} = 3.3 V, V _{IN} = 0 V or V _{CC} | 9 | pF |
| | | 10 MHz, V _{CC} = 5.5 V, V _{IN} = 0 V or V _{CC} | 11 | |

5. C_{PD} is defined as the value of the internal equivalent capacitance which is calculated from the operating current consumption without load. Average operating current can be obtained by the equation: I_{CC(OPR)} = C_{PD} • V_{CC} • f_{in} + I_{CC}. C_{PD} is used to determine the no-load dynamic power consumption; P_D = C_{PD} • V_{CC}² • f_{in} + I_{CC} • V_{CC}.

NL17SZ02



C_L includes probe and jig capacitance
 R_T is Z_{OUT} of pulse generator (typically 50 Ω)
 $f = 1$ MHz

Figure 3. Test Circuit

| Test | Switch Position | C_L , pF | R_L , Ω | R_1 , Ω |
|---------------------|-------------------|------------------------------|------------------|------------------|
| t_{PLH} / t_{PHL} | Open | See AC Characteristics Table | | |
| t_{PLZ} / t_{PZL} | $2 \times V_{CC}$ | 50 | 500 | 500 |
| t_{PHZ} / t_{PZH} | GND | 50 | 500 | 500 |

X = Don't Care



Figure 4. Switching Waveforms

| V_{CC} , V | V_{mi} , V | V_{mo} , V | | V_Y , V |
|--------------|--------------|--------------------|--------------------------------------|-----------|
| | | t_{PLH}, t_{PHL} | $t_{PZL}, t_{PLZ}, t_{PZH}, t_{PHZ}$ | |
| 1.65 to 1.95 | $V_{CC}/2$ | $V_{CC}/2$ | $V_{CC}/2$ | 0.15 |
| 2.3 to 2.7 | $V_{CC}/2$ | $V_{CC}/2$ | $V_{CC}/2$ | 0.15 |
| 3.0 to 3.6 | $V_{CC}/2$ | $V_{CC}/2$ | $V_{CC}/2$ | 0.3 |
| 4.5 to 5.5 | $V_{CC}/2$ | $V_{CC}/2$ | $V_{CC}/2$ | 0.3 |

NL17SZ02

DEVICE ORDERING INFORMATION

| Device | Packages | Specific Device Code | Pin 1 Orientation (See below) | Shipping† |
|------------------------------------|-------------------------|-----------------------|----------------------------------|--------------------|
| NL17SZ02DFT2G | SC-88A | L3 | Q4 | 3000 / Tape & Reel |
| NLV17SZ02DFT2G* | SC-88A | L3 | Q4 | 3000 / Tape & Reel |
| NL17SZ02DBVT1G | SC-74A | AC | Q4 | 3000 / Tape & Reel |
| NL17SZ02XV5T2G | SOT-553 | L3 | Q4 | 4000 / Tape & Reel |
| NL17SZ02P5T5G | SOT-953 | 4 (Rotated 90° CW) | Q2 | 8000 / Tape & Reel |
| NL17SZ02MU1TCG (In Development) | UDFN6, 1.45 x 1.0, 0.5P | TBD | Q4 | 3000 / Tape & Reel |
| NL17SZ02MU3TCG (In Development) | UDFN6, 1.0 x 1.0, 0.35P | J | Q4 | 3000 / Tape & Reel |

†For information on tape and reel specifications, including part orientation and tape sizes, please refer to our Tape and Reel Packaging Specifications Brochure, BRD8011/D.

*NLV Prefix for Automotive and Other Applications Requiring Unique Site and Control Change Requirements; AEC-Q100 Qualified and PPAP Capable.

Pin 1 Orientation in Tape and Reel

Direction of Feed

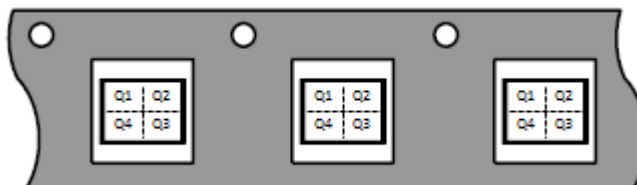

MECHANICAL CASE OUTLINE

PACKAGE DIMENSIONS

ON Semiconductor®



SCALE 2:1

SC-74A CASE 318BQ ISSUE B

DATE 18 JAN 2018

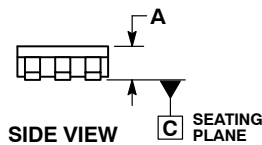
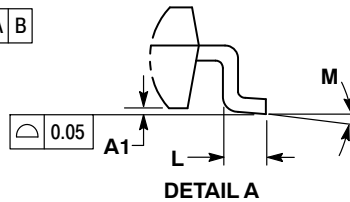
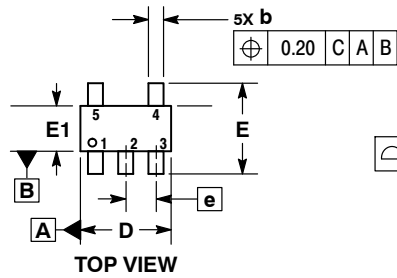

NOTES:

1. DIMENSIONING AND TOLERANCING PER ASME Y14.5M, 1994.
2. CONTROLLING DIMENSION: MILLIMETERS.
3. MAXIMUM LEAD THICKNESS INCLUDES LEAD FINISH THICKNESS. MINIMUM LEAD THICKNESS IS THE MINIMUM THICKNESS OF BASE MATERIAL.
4. DIMENSIONS A AND B DO NOT INCLUDE MOLD FLASH, PROTRUSIONS, OR GATE BURRS. MOLD FLASH, PROTRUSIONS, OR GATE BURRS SHALL NOT EXCEED 0.15 PER SIDE.

| DIM | MILLIMETERS | |
|-----|-------------|------|
| | MIN | MAX |
| A | 0.90 | 1.10 |
| A1 | 0.01 | 0.10 |
| b | 0.25 | 0.50 |
| c | 0.10 | 0.26 |
| D | 2.85 | 3.15 |
| E | 2.50 | 3.00 |
| E1 | 1.35 | 1.65 |
| e | 0.95 BSC | |
| L | 0.20 | 0.60 |
| M | 0° | 10° |

RECOMMENDED SOLDERING FOOTPRINT*

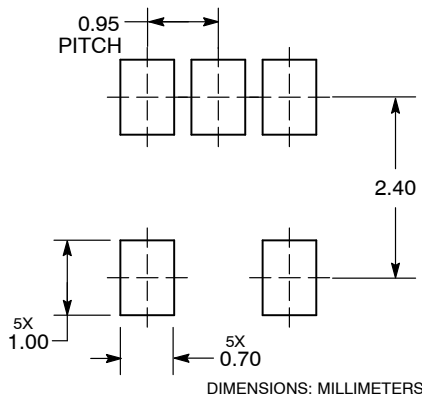

GENERIC MARKING DIAGRAM*

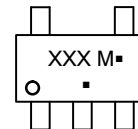

- XXX = Specific Device Code
- M = Date Code
- = Pb-Free Package

(Note: Microdot may be in either location)

*This information is generic. Please refer to device data sheet for actual part marking. Pb-Free indicator, "G" or microdot "▪", may or may not be present. Some products may not follow the Generic Marking.

*For additional information on our Pb-Free strategy and soldering details, please download the ON Semiconductor Soldering and Mounting Techniques Reference Manual, SOLDERRM/D.

| | | |
|-------------------------|--------------------|--|
| DOCUMENT NUMBER: | 98AON66279G | Electronic versions are uncontrolled except when accessed directly from the Document Repository. Printed versions are uncontrolled except when stamped "CONTROLLED COPY" in red. |
| DESCRIPTION: | SC-74A | PAGE 1 OF 1 |

ON Semiconductor and are trademarks of Semiconductor Components Industries, LLC dba ON Semiconductor or its subsidiaries in the United States and/or other countries. ON Semiconductor reserves the right to make changes without further notice to any products herein. ON Semiconductor makes no warranty, representation or guarantee regarding the suitability of its products for any particular purpose, nor does ON Semiconductor assume any liability arising out of the application or use of any product or circuit, and specifically disclaims any and all liability, including without limitation special, consequential or incidental damages. ON Semiconductor does not convey any license under its patent rights nor the rights of others.

MECHANICAL CASE OUTLINE

PACKAGE DIMENSIONS

ON Semiconductor®



SCALE 2:1

SC-88A (SC-70-5/SOT-353)
CASE 419A-02
ISSUE L

DATE 17 JAN 2013



SOLDER FOOTPRINT



NOTES:

1. DIMENSIONING AND TOLERANCING PER ANSI Y14.5M, 1982.
2. CONTROLLING DIMENSION: INCH.
3. 419A-01 OBSOLETE. NEW STANDARD 419A-02.
4. DIMENSIONS A AND B DO NOT INCLUDE MOLD FLASH, PROTRUSIONS, OR GATE BURRS.

| DIM | INCHES | | MILLIMETERS | |
|-----|-----------|-------|-------------|------|
| | MIN | MAX | MIN | MAX |
| A | 0.071 | 0.087 | 1.80 | 2.20 |
| B | 0.045 | 0.053 | 1.15 | 1.35 |
| C | 0.031 | 0.043 | 0.80 | 1.10 |
| D | 0.004 | 0.012 | 0.10 | 0.30 |
| G | 0.026 BSC | | 0.65 BSC | |
| H | --- | 0.004 | --- | 0.10 |
| J | 0.004 | 0.010 | 0.10 | 0.25 |
| K | 0.004 | 0.012 | 0.10 | 0.30 |
| N | 0.008 REF | | 0.20 REF | |
| S | 0.079 | 0.087 | 2.00 | 2.20 |

GENERIC MARKING DIAGRAM*



- XXX = Specific Device Code
- M = Date Code
- = Pb-Free Package

(Note: Microdot may be in either location)

*This information is generic. Please refer to device data sheet for actual part marking. Pb-Free indicator, "G" or microdot "▪", may or may not be present. Some products may not follow the Generic Marking.

- | | | | | |
|--|--|--|--|--|
| <p>STYLE 1: PIN 1. BASE 2. EMITTER 3. BASE 4. COLLECTOR 5. COLLECTOR</p> | <p>STYLE 2: PIN 1. ANODE 2. EMITTER 3. BASE 4. COLLECTOR 5. CATHODE</p> | <p>STYLE 3: PIN 1. ANODE 1 2. N/C 3. ANODE 2 4. CATHODE 2 5. CATHODE 1</p> | <p>STYLE 4: PIN 1. SOURCE 1 2. DRAIN 1/2 3. SOURCE 1 4. GATE 1 5. GATE 2</p> | <p>STYLE 5: PIN 1. CATHODE 2. COMMON ANODE 3. CATHODE 2 4. CATHODE 3 5. CATHODE 4</p> |
| <p>STYLE 6: PIN 1. EMITTER 2 2. BASE 2 3. EMITTER 1 4. COLLECTOR 5. COLLECTOR 2/BASE 1</p> | <p>STYLE 7: PIN 1. BASE 2. EMITTER 3. BASE 4. COLLECTOR 5. COLLECTOR</p> | <p>STYLE 8: PIN 1. CATHODE 2. COLLECTOR 3. N/C 4. BASE 5. EMITTER</p> | <p>STYLE 9: PIN 1. ANODE 2. CATHODE 3. ANODE 4. ANODE 5. ANODE</p> | <p>Note: Please refer to datasheet for style callout. If style type is not called out in the datasheet refer to the device datasheet pinout or pin assignment.</p> |

| | | |
|------------------|--------------------------|--|
| DOCUMENT NUMBER: | 98ASB42984B | Electronic versions are uncontrolled except when accessed directly from the Document Repository. Printed versions are uncontrolled except when stamped "CONTROLLED COPY" in red. |
| DESCRIPTION: | SC-88A (SC-70-5/SOT-353) | PAGE 1 OF 1 |

ON Semiconductor and ON are trademarks of Semiconductor Components Industries, LLC dba ON Semiconductor or its subsidiaries in the United States and/or other countries. ON Semiconductor reserves the right to make changes without further notice to any products herein. ON Semiconductor makes no warranty, representation or guarantee regarding the suitability of its products for any particular purpose, nor does ON Semiconductor assume any liability arising out of the application or use of any product or circuit, and specifically disclaims any and all liability, including without limitation special, consequential or incidental damages. ON Semiconductor does not convey any license under its patent rights nor the rights of others.

MECHANICAL CASE OUTLINE

PACKAGE DIMENSIONS

ON Semiconductor®



SCALE 4:1

SOT-553, 5 LEAD CASE 463B ISSUE C

DATE 20 MAR 2013

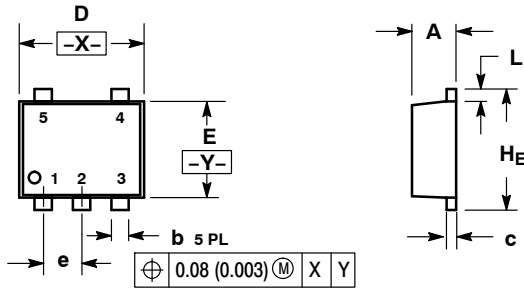

NOTES:

1. DIMENSIONING AND TOLERANCING PER ANSI Y14.5M, 1982.
2. CONTROLLING DIMENSION: MILLIMETERS
3. MAXIMUM LEAD THICKNESS INCLUDES LEAD FINISH THICKNESS. MINIMUM LEAD THICKNESS IS THE MINIMUM THICKNESS OF BASE MATERIAL.

| DIM | MILLIMETERS | | | INCHES | | |
|----------------|-------------|------|------|-----------|-------|-------|
| | MIN | NOM | MAX | MIN | NOM | MAX |
| A | 0.50 | 0.55 | 0.60 | 0.020 | 0.022 | 0.024 |
| b | 0.17 | 0.22 | 0.27 | 0.007 | 0.009 | 0.011 |
| c | 0.08 | 0.13 | 0.18 | 0.003 | 0.005 | 0.007 |
| D | 1.55 | 1.60 | 1.65 | 0.061 | 0.063 | 0.065 |
| E | 1.15 | 1.20 | 1.25 | 0.045 | 0.047 | 0.049 |
| e | 0.50 BSC | | | 0.020 BSC | | |
| L | 0.10 | 0.20 | 0.30 | 0.004 | 0.008 | 0.012 |
| H _E | 1.55 | 1.60 | 1.65 | 0.061 | 0.063 | 0.065 |

RECOMMENDED SOLDERING FOOTPRINT*

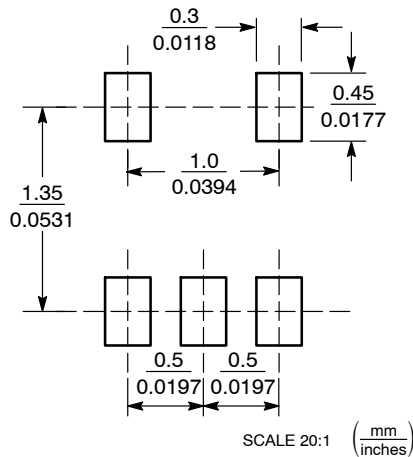

GENERIC MARKING DIAGRAM*



- XX = Specific Device Code
- M = Date Code
- = Pb-Free Package

(Note: Microdot may be in either location)

*This information is generic. Please refer to device data sheet for actual part marking. Pb-Free indicator, "G" or microdot "▪", may or may not be present.

*For additional information on our Pb-Free strategy and soldering details, please download the ON Semiconductor Soldering and Mounting Techniques Reference Manual, SOLDERRM/D.

STYLE 1:

- PIN 1. BASE
- 2. EMITTER
- 3. BASE
- 4. COLLECTOR
- 5. COLLECTOR

STYLE 2:

- PIN 1. CATHODE
- 2. COMMON ANODE
- 3. CATHODE 2
- 4. CATHODE 3
- 5. CATHODE 4

STYLE 3:

- PIN 1. ANODE 1
- 2. N/C
- 3. ANODE 2
- 4. CATHODE 2
- 5. CATHODE 1

STYLE 4:

- PIN 1. SOURCE 1
- 2. DRAIN 1/2
- 3. SOURCE 1
- 4. GATE 1
- 5. GATE 2

STYLE 5:

- PIN 1. ANODE
- 2. EMITTER
- 3. BASE
- 4. COLLECTOR
- 5. CATHODE

STYLE 6:

- PIN 1. EMITTER 2
- 2. BASE 2
- 3. EMITTER 1
- 4. COLLECTOR 1
- 5. COLLECTOR 2/BASE 1

STYLE 7:

- PIN 1. BASE
- 2. EMITTER
- 3. BASE
- 4. COLLECTOR
- 5. COLLECTOR

STYLE 8:

- PIN 1. CATHODE
- 2. COLLECTOR
- 3. N/C
- 4. BASE
- 5. EMITTER

STYLE 9:

- PIN 1. ANODE
- 2. CATHODE
- 3. ANODE
- 4. ANODE
- 5. ANODE

| | | |
|------------------|---------------------------|--|
| DOCUMENT NUMBER: | 98AON11127D | Electronic versions are uncontrolled except when accessed directly from the Document Repository. Printed versions are uncontrolled except when stamped "CONTROLLED COPY" in red. |
| STATUS: | ON SEMICONDUCTOR STANDARD | |
| NEW STANDARD: | | |
| DESCRIPTION: | SOT-553, 5 LEAD | PAGE 1 OF 2 |

MECHANICAL CASE OUTLINE PACKAGE DIMENSIONS

ON Semiconductor®



SCALE 4:1

SOT-953
CASE 527AE
ISSUE E

DATE 02 AUG 2011

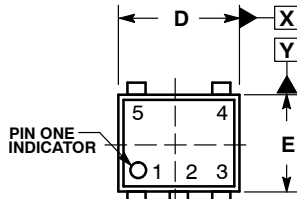

TOP VIEW

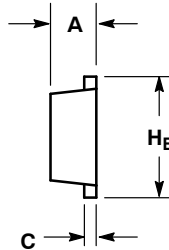

SIDE VIEW

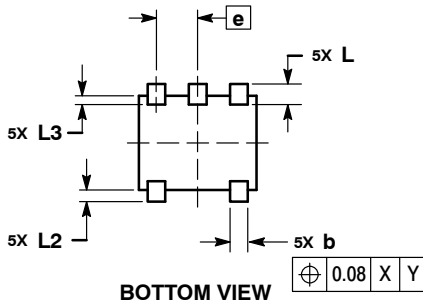

BOTTOM VIEW

SOLDERING FOOTPRINT*

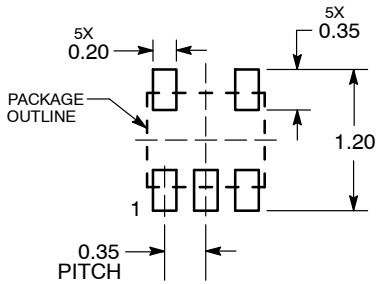

DIMENSIONS: MILLIMETERS

NOTES:

1. DIMENSIONING AND TOLERANCING PER ASME Y14.5M, 1994.
2. CONTROLLING DIMENSION: MILLIMETERS
3. MAXIMUM LEAD THICKNESS INCLUDES LEAD FINISH. MINIMUM LEAD THICKNESS IS THE MINIMUM THICKNESS OF THE BASE MATERIAL.
4. DIMENSIONS D AND E DO NOT INCLUDE MOLD FLASH, PROTRUSIONS, OR GATE BURRS.

| DIM | MILLIMETERS | | |
|-----|-------------|------|------|
| | MIN | NOM | MAX |
| A | 0.34 | 0.37 | 0.40 |
| b | 0.10 | 0.15 | 0.20 |
| C | 0.07 | 0.12 | 0.17 |
| D | 0.95 | 1.00 | 1.05 |
| E | 0.75 | 0.80 | 0.85 |
| e | 0.35 BSC | | |
| HE | 0.95 | 1.00 | 1.05 |
| L | 0.175 REF | | |
| L2 | 0.05 | 0.10 | 0.15 |
| L3 | --- | --- | 0.15 |

GENERIC MARKING DIAGRAM*

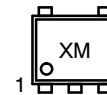

- X = Specific Device Code
- M = Month Code

*This information is generic. Please refer to device data sheet for actual part marking.
Pb-Free indicator, "G" or microdot "▪", may or may not be present.

*For additional information on our Pb-Free strategy and soldering details, please download the ON Semiconductor Soldering and Mounting Techniques Reference Manual, SOLDERRM/D.

| | | |
|-------------------------|--------------------|--|
| DOCUMENT NUMBER: | 98AON26457D | Electronic versions are uncontrolled except when accessed directly from the Document Repository. Printed versions are uncontrolled except when stamped "CONTROLLED COPY" in red. |
| DESCRIPTION: | SOT-953 | PAGE 1 OF 1 |

ON Semiconductor and are trademarks of Semiconductor Components Industries, LLC dba ON Semiconductor or its subsidiaries in the United States and/or other countries. ON Semiconductor reserves the right to make changes without further notice to any products herein. ON Semiconductor makes no warranty, representation or guarantee regarding the suitability of its products for any particular purpose, nor does ON Semiconductor assume any liability arising out of the application or use of any product or circuit, and specifically disclaims any and all liability, including without limitation special, consequential or incidental damages. ON Semiconductor does not convey any license under its patent rights nor the rights of others.

ON Semiconductor and  are trademarks of Semiconductor Components Industries, LLC dba ON Semiconductor or its subsidiaries in the United States and/or other countries. ON Semiconductor owns the rights to a number of patents, trademarks, copyrights, trade secrets, and other intellectual property. A listing of ON Semiconductor's product/patent coverage may be accessed at www.onsemi.com/site/pdf/Patent-Marking.pdf. ON Semiconductor reserves the right to make changes without further notice to any products herein. ON Semiconductor makes no warranty, representation or guarantee regarding the suitability of its products for any particular purpose, nor does ON Semiconductor assume any liability arising out of the application or use of any product or circuit, and specifically disclaims any and all liability, including without limitation special, consequential or incidental damages. Buyer is responsible for its products and applications using ON Semiconductor products, including compliance with all laws, regulations and safety requirements or standards, regardless of any support or applications information provided by ON Semiconductor. "Typical" parameters which may be provided in ON Semiconductor data sheets and/or specifications can and do vary in different applications and actual performance may vary over time. All operating parameters, including "Typicals" must be validated for each customer application by customer's technical experts. ON Semiconductor does not convey any license under its patent rights nor the rights of others. ON Semiconductor products are not designed, intended, or authorized for use as a critical component in life support systems or any FDA Class 3 medical devices or medical devices with a same or similar classification in a foreign jurisdiction or any devices intended for implantation in the human body. Should Buyer purchase or use ON Semiconductor products for any such unintended or unauthorized application, Buyer shall indemnify and hold ON Semiconductor and its officers, employees, subsidiaries, affiliates, and distributors harmless against all claims, costs, damages, and expenses, and reasonable attorney fees arising out of, directly or indirectly, any claim of personal injury or death associated with such unintended or unauthorized use, even if such claim alleges that ON Semiconductor was negligent regarding the design or manufacture of the part. ON Semiconductor is an Equal Opportunity/Affirmative Action Employer. This literature is subject to all applicable copyright laws and is not for resale in any manner.

PUBLICATION ORDERING INFORMATION

LITERATURE FULFILLMENT:

Email Requests to: orderlit@onsemi.com

ON Semiconductor Website: www.onsemi.com

TECHNICAL SUPPORT

North American Technical Support:
Voice Mail: 1 800-282-9855 Toll Free USA/Canada
Phone: 011 421 33 790 2910

Europe, Middle East and Africa Technical Support:

Phone: 00421 33 790 2910

For additional information, please contact your local Sales Representative