

NL17SHT126

Noninverting Buffer / CMOS Logic Level Shifter with LSTTL-Compatible Inputs

The NL17SHT126 is a single gate noninverting 3-state buffer fabricated with silicon gate CMOS technology. It achieves high speed operation similar to equivalent Bipolar Schottky TTL while maintaining CMOS low power dissipation.

The NL17SHT126 requires the 3-state control input (OE) to be set Low to place the output into the high impedance state.

The device input is compatible with TTL-type input thresholds and the output has a full 5 V CMOS level output swing. The input protection circuitry on this device allows overvoltage tolerance on the input, allowing the device to be used as a logic-level translator from 3 V CMOS logic to 5 V CMOS Logic or from 1.8 V CMOS logic to 3 V CMOS Logic while operating at the high-voltage power supply.

The NL17SHT126 input structure provides protection when voltages up to 7 V are applied, regardless of the supply voltage. This allows the NL17SHT126 to be used to interface 5 V circuits to 3 V circuits. The output structures also provide protection when $V_{CC} = 0$ V. These input and output structures help prevent device destruction caused by supply voltage – input/output voltage mismatch, battery backup, hot insertion, etc.

Features

- High Speed: $t_{PD} = 3.5$ ns (Typ) at $V_{CC} = 5$ V
- Low Power Dissipation: $I_{CC} = 1$ μ A (Max) at $T_A = 25^\circ$ C
- TTL-Compatible Inputs: $V_{IL} = 0.8$ V; $V_{IH} = 2$ V
- CMOS-Compatible Outputs: $V_{OH} > 0.8 V_{CC}$; $V_{OL} < 0.1 V_{CC}$ @Load
- Power Down Protection Provided on Inputs and Outputs
- Balanced Propagation Delays
- Pin and Function Compatible with Other Standard Logic Families
- These are Pb-Free Devices

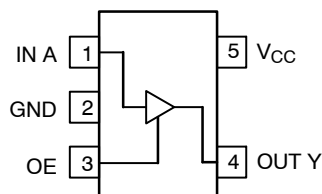

Figure 1. Pinout (Top View)

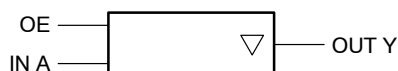

Figure 2. Logic Symbol



ON Semiconductor®

<http://onsemi.com>

MARKING DIAGRAM



SOT-953
CASE 527AE

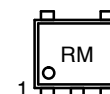

R = Specific Device Code
M = Month Code

PIN ASSIGNMENT

| Pin | Function |
|-----|----------|
| 1 | IN A |
| 2 | GND |
| 3 | OE |
| 4 | OUT Y |
| 5 | V_{CC} |

FUNCTION TABLE

| A Input | OE Input | Y Output |
|---------|----------|----------|
| L | H | L |
| H | H | H |
| X | L | Z |

ORDERING INFORMATION

See detailed ordering and shipping information in the package dimensions section on page 4 of this data sheet.

NL17SHT126

MAXIMUM RATINGS

| Symbol | Characteristics | Value | Unit |
|----------------------|--|--|------|
| V _{CC} | DC Supply Voltage | -0.5 to +7.0 | V |
| V _{IN} | DC Input Voltage | -0.5 to +7.0 | V |
| V _{OUT} | DC Output Voltage | -0.5 to V _{CC} + 0.5 | V |
| I _{IK} | Input Diode Current | -20 | mA |
| I _{OK} | Output Diode Current | V _{OUT} < GND; V _{OUT} > V _{CC} | ±20 |
| I _{OUT} | DC Output Current | ±25 | mA |
| I _{CC} | DC Supply Current, V _{CC} and GND | 50 | mA |
| P _D | Power Dissipation in Still Air | 50 | mW |
| T _L | Lead Temperature, 1 mm from Case for 10 s | 260 | °C |
| T _J | Junction Temperature Under Bias | +150 | °C |
| T _{stg} | Storage Temperature | -65 to +150 | °C |
| I _{Latchup} | Latchup Performance | Above V _{CC} and Below GND at 125°C (Note 1) | ±100 |

Stresses exceeding Maximum Ratings may damage the device. Maximum Ratings are stress ratings only. Functional operation above the Recommended Operating Conditions is not implied. Extended exposure to stresses above the Recommended Operating Conditions may affect device reliability.

1. Tested to EIA/JESD78

RECOMMENDED OPERATING CONDITIONS

| Symbol | Characteristics | Min | Max | Unit |
|---------------------------------|-----------------------------|---------------------------------|-----------------|------|
| V _{CC} | DC Supply Voltage | 3.0 | 5.5 | V |
| V _{IN} | DC Input Voltage | 0.0 | 5.5 | V |
| V _{OUT} | DC Output Voltage | 0.0 | V _{CC} | V |
| T _A | Operating Temperature Range | -55 | +125 | °C |
| t _r , t _f | Input Rise and Fall Time | V _{CC} = 5.0 V ± 0.5 V | 0 | 20 |

Device Junction Temperature versus Time to 0.1% Bond Failures

| Junction Temperature °C | Time, Hours | Time, Years |
|-------------------------|-------------|-------------|
| 80 | 1,032,200 | 117.8 |
| 90 | 419,300 | 47.9 |
| 100 | 178,700 | 20.4 |
| 110 | 79,600 | 9.4 |
| 120 | 37,000 | 4.2 |
| 130 | 17,800 | 2.0 |
| 140 | 8,900 | 1.0 |

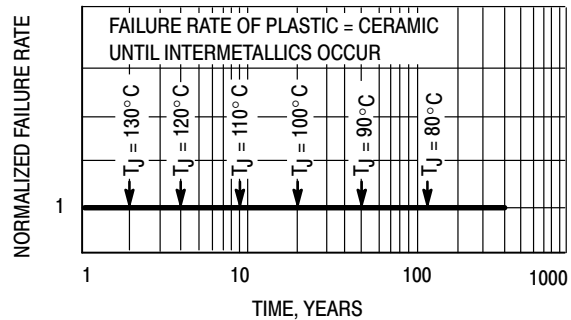

Figure 3. Failure Rate vs. Time Junction Temperature

NL17SHT126

DC ELECTRICAL CHARACTERISTICS

| Symbol | Parameter | Test Conditions | V _{CC} (V) | T _A = 25°C | | | T _A ≤ 85°C | | -55 ≤ T _A ≤ 125°C | | Unit |
|------------------|---|--|------------------------|-----------------------|------------|--------------|-----------------------|--------------|------------------------------|--------------|------|
| | | | | Min | Typ | Max | Min | Max | Min | Max | |
| V _{IH} | Minimum High-Level Input Voltage | | 3.0 | 1.4 | | | 1.4 | | 1.4 | | V |
| | | | 4.5 | 2.0 | | | 2.0 | | 2.0 | | |
| | | | 5.5 | 2.0 | | | 2.0 | | 2.0 | | |
| V _{IL} | Maximum Low-Level Input Voltage | | 3.0 | | | | | | | | V |
| | | | 4.5 | | | 0.53 | | 0.53 | | 0.53 | |
| | | | 5.5 | | | 0.8 | | 0.8 | | 0.8 | |
| V _{OH} | Minimum High-Level Output Voltage V _{IN} = V _{IH} or V _{IL} | V _{IN} = V _{IH} or V _{IL} I _{OH} = - 50 μA | 3.0 4.5 | 2.9 4.4 | 3.0 4.5 | | 2.9 4.4 | | 2.9 4.4 | | V |
| | | V _{IN} = V _{IH} or V _{IL} I _{OH} = - 4 mA I _{OH} = - 8 mA | 3.0 4.5 | 2.58 3.94 | | | 2.48 3.80 | | 2.34 3.66 | | |
| V _{OL} | Maximum Low-Level Output Voltage V _{IN} = V _{IH} or V _{IL} | V _{IN} = V _{IH} or V _{IL} I _{OL} = 50 μA | 3.0 4.5 | | 0.0 0.0 | 0.1 0.1 | | 0.1 0.1 | | 0.1 0.1 | V |
| | | V _{IN} = V _{IH} or V _{IL} I _{OL} = 4 mA I _{OL} = 8 mA | 3.0 4.5 | | | 0.36 0.36 | | 0.44 0.44 | | 0.52 0.52 | |
| I _{IN} | Maximum Input Leakage Current | V _{IN} = 5.5 V or GND | 0 to 5.5 | | | ± 0.1 | | ± 1.0 | | ± 1.0 | μA |
| I _{CC} | Maximum Quiescent Supply Current | V _{IN} = V _{CC} or GND | 5.5 | | | 1.0 | | 20 | | 40 | μA |
| I _{CCT} | Quiescent Supply Current | Input: V _{IN} = 3.4 V Other Input: V _{CC} or GND | 5.5 | | | 1.35 | | 1.50 | | 1.65 | mA |
| I _{OPD} | Output Leakage Current | V _{OUT} = 5.5 V | 0.0 | | | 0.5 | | 5.0 | | 10 | μA |
| I _{OZ} | Maximum 3-State Leakage Current | V _{IN} = V _{IH} or V _{IL} V _{OUT} = V _{CC} or GND | 5.5 | | | ± 0.25 | | ± 2.5 | | ± 2.5 | μA |

AC ELECTRICAL CHARACTERISTICS Input t_r = t_f = 3.0 ns

| Symbol | Parameter | Test Conditions | T _A = 25°C | | | T _A ≤ 85°C | | -55 ≤ T _A ≤ 125°C | | Unit |
|--|--|--|-----------------------|------------|-------------|-----------------------|--------------|------------------------------|--------------|------|
| | | | Min | Typ | Max | Min | Max | Min | Max | |
| t _{PLH} , t _{PHL} | Maximum Propagation Delay, A to Y (Figures 3 and 5) | V _{CC} = 3.3 ± 0.3 V C _L = 15pF C _L = 50pF | | 5.6 8.1 | 8.0 11.5 | 1.0 1.0 | 9.5 13.0 | | 12.0 16.0 | ns |
| | | V _{CC} = 5.0 ± 0.5 V C _L = 15pF C _L = 50pF | | 3.8 5.3 | 5.5 7.5 | 1.0 1.0 | 6.5 8.5 | | 8.5 10.5 | |
| t _{PZL} , t _{PZH} | Maximum Output Enable Time, OE to Y (Figures 4 and 5) | V _{CC} = 3.3 ± 0.3 V C _L = 15pF R _L = R _I = 500 Ω C _L = 50pF | | 5.4 7.9 | 8.0 11.5 | 1.0 1.0 | 9.5 13.0 | | 11.5 15.0 | ns |
| | | V _{CC} = 5.0 ± 0.5 V C _L = 15pF R _L = R _I = 500 Ω C _L = 50pF | | 3.6 5.1 | 5.1 7.1 | 1.0 1.0 | 6.0 8.0 | | 7.5 9.5 | |
| t _{PLZ} , t _{PHZ} | Maximum Output Disable Time, OE to Y (Figures 4 and 5) | V _{CC} = 3.3 ± 0.3 V C _L = 15pF R _L = R _I = 500 Ω C _L = 50pF | | 6.5 8.0 | 9.7 13.2 | 1.0 1.0 | 11.5 15.0 | | 14.5 18.0 | ns |
| | | V _{CC} = 5.0 ± 0.5 V C _L = 15pF R _L = R _I = 500 Ω C _L = 50pF | | 4.8 7.0 | 6.8 8.8 | 1.0 1.0 | 8.0 10.0 | | 10.0 12.0 | |
| C _{in} | Maximum Input Capacitance | | | 4 | 10 | | 10 | | 10 | pF |
| C _{out} | Maximum Three-State Output Capacitance (Output in High Impedance State) | | | 6 | | | | | | pF |
| C _{PD} | Power Dissipation Capacitance (Note 2) | Typical @ 25°C, V_{CC} = 5.0 V | | | | | | | | pF |
| | | 14 | | | | | | | | |

2. C_{PD} is defined as the value of the internal equivalent capacitance which is calculated from the operating current consumption without load. Average operating current can be obtained by the equation: I_{CC(OPR)} = C_{PD} • V_{CC} • f_{in} + I_{CC}/4 (per buffer). C_{PD} is used to determine the no-load dynamic power consumption; P_D = C_{PD} • V_{CC}² • f_{in} + I_{CC} • V_{CC}.

NL17SHT126

SWITCHING WAVEFORMS

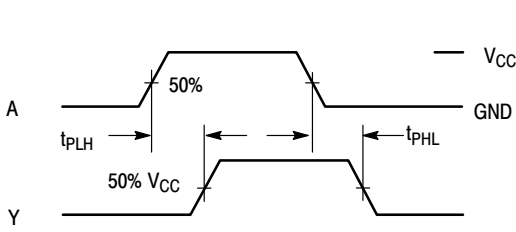

Figure 4. Switching Waveforms

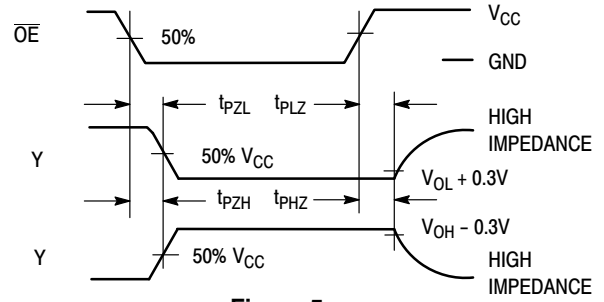
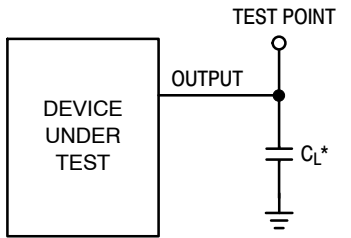
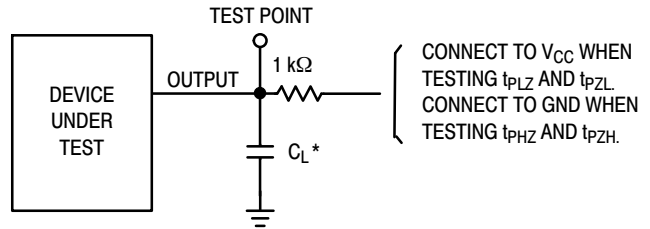

Figure 5.



*Includes all probe and jig capacitance

Figure 6. Test Circuit



*Includes all probe and jig capacitance

Figure 7. Test Circuit

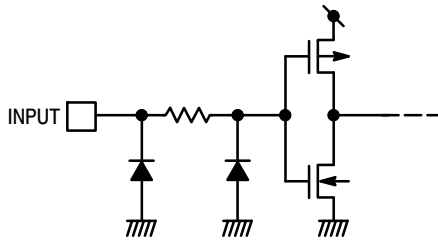

Figure 8. Input Equivalent Circuit

ORDERING INFORMATION

| Device | Package | Shipping [†] |
|-----------------|----------------------|-----------------------|
| NL17SHT126P5T5G | SOT-953 (Pb-Free) | 8000 / Tape & Reel |

[†]For information on tape and reel specifications, including part orientation and tape sizes, please refer to our Tape and Reel Packaging Specifications Brochure, BRD8011/D.

onsemi, **Onsemi**, and other names, marks, and brands are registered and/or common law trademarks of Semiconductor Components Industries, LLC dba "**onsemi**" or its affiliates and/or subsidiaries in the United States and/or other countries. **onsemi** owns the rights to a number of patents, trademarks, copyrights, trade secrets, and other intellectual property. A listing of **onsemi**'s product/patent coverage may be accessed at www.onsemi.com/site/pdf/Patent-Marking.pdf. **onsemi** reserves the right to make changes at any time to any products or information herein, without notice. The information herein is provided "as-is" and **onsemi** makes no warranty, representation or guarantee regarding the accuracy of the information, product features, availability, functionality, or suitability of its products for any particular purpose, nor does **onsemi** assume any liability arising out of the application or use of any product or circuit, and specifically disclaims any and all liability, including without limitation special, consequential or incidental damages. Buyer is responsible for its products and applications using **onsemi** products, including compliance with all laws, regulations and safety requirements or standards, regardless of any support or applications information provided by **onsemi**. "Typical" parameters which may be provided in **onsemi** data sheets and/or specifications can and do vary in different applications and actual performance may vary over time. All operating parameters, including "Typicals" must be validated for each customer application by customer's technical experts. **onsemi** does not convey any license under any of its intellectual property rights nor the rights of others. **onsemi** products are not designed, intended, or authorized for use as a critical component in life support systems or any FDA Class 3 medical devices or medical devices with a same or similar classification in a foreign jurisdiction or any devices intended for implantation in the human body. Should Buyer purchase or use **onsemi** products for any such unintended or unauthorized application, Buyer shall indemnify and hold **onsemi** and its officers, employees, subsidiaries, affiliates, and distributors harmless against all claims, costs, damages, and expenses, and reasonable attorney fees arising out of, directly or indirectly, any claim of personal injury or death associated with such unintended or unauthorized use, even if such claim alleges that **onsemi** was negligent regarding the design or manufacture of the part. **onsemi** is an Equal Opportunity/Affirmative Action Employer. This literature is subject to all applicable copyright laws and is not for resale in any manner.

ADDITIONAL INFORMATION

TECHNICAL PUBLICATIONS:

Technical Library: www.onsemi.com/design/resources/technical-documentation
onsemi Website: www.onsemi.com

ONLINE SUPPORT: www.onsemi.com/support

For additional information, please contact your local Sales Representative at www.onsemi.com/support/sales