

NJL21193DG (PNP), NJL21194DG (NPN)

Complementary ThermalTrak™ Transistors

The ThermalTrak family of devices has been designed to eliminate thermal equilibrium lag time and bias trimming in audio amplifier applications. They can also be used in other applications as transistor die protection devices.

Features

- Thermally Matched Bias Diode
- Instant Thermal Bias Tracking
- Absolute Thermal Integrity
- Medium Frequency Device with Extended Safe Operating Area
- These are Pb-Free Devices

Benefits

- Eliminates Thermal Equilibrium Lag Time and Bias Trimming
- Superior Sound Quality Through Improved Dynamic Temperature Response
- Significantly Improved Bias Stability
- Simplified Assembly
 - ◆ Reduced Labor Costs
 - ◆ Reduced Component Count
- High Reliability

Applications

- High-End Consumer Audio Products
 - ◆ Home Amplifiers
 - ◆ Home Receivers
- Professional Audio Amplifiers
 - ◆ Theater and Stadium Sound Systems
 - ◆ Public Address Systems (PAs)



ON Semiconductor®

<http://onsemi.com>

**BIPOLAR POWER
TRANSISTORS
16 A, 250 V, 200 W**

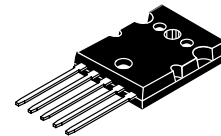

TO-264, 5 LEAD
CASE 340AA
STYLE 1

MARKING DIAGRAM

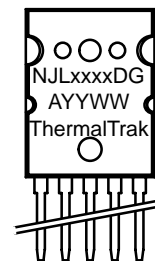

SCHEMATIC

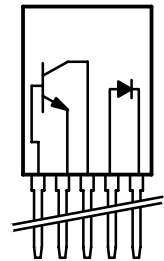

xxxx = Specific Device Code
G = Pb-Free Device
A = Assembly Location
YY = Year
WW = Work Week

ORDERING INFORMATION

See detailed ordering and shipping information in the package dimensions section on page 2 of this data sheet.

*For additional information on our Pb-Free strategy and soldering details, please download the ON Semiconductor Soldering and Mounting Techniques Reference Manual, SOLDERRM/D.

NJL21193DG (PNP), NJL21194DG (NPN)

MAXIMUM RATINGS (T_J = 25°C unless otherwise noted)

Rating	Symbol	Value	Unit
Collector–Emitter Voltage	V _{CEO}	250	Vdc
Collector–Base Voltage	V _{CBO}	400	Vdc
Emitter–Base Voltage	V _{EBO}	5	Vdc
Collector–Emitter Voltage – 1.5 V	V _{CEx}	400	Vdc
Collector Current	I _C	16 30	Adc
			– Continuous – Peak (Note 1)
Base Current – Continuous	I _B	5.0	Adc
Total Power Dissipation @ T _C = 25°C Derate Above 25°C	P _D	200 1.43	W W/°C
Operating and Storage Junction Temperature Range	T _J , T _{stg}	– 65 to +150	°C
DC Blocking Voltage	V _R	200	V
Average Rectified Forward Current	I _{F(AV)}	1.0	A

THERMAL CHARACTERISTICS

Characteristic	Symbol	Max	Unit
Thermal Resistance, Junction–to–Case	R _{θJC}	0.625	°C/W

Maximum ratings are those values beyond which device damage can occur. Maximum ratings applied to the device are individual stress limit values (not normal operating conditions) and are not valid simultaneously. If these limits are exceeded, device functional operation is not implied, damage may occur and reliability may be affected.

1. Pulse Test: Pulse Width = 5 ms, Duty Cycle < 10%.

ATTRIBUTES

Characteristic	Value
ESD Protection	Human Body Model Machine Model
	>8000 V > 400 V
Flammability Rating	UL 94 V–0 @ 0.125 in

ORDERING INFORMATION

Device	Package	Shipping
NJL21193DG	TO–264 (Pb–Free)	25 Units / Rail
NJL21194DG	TO–264 (Pb–Free)	25 Units / Rail

NJL21193DG (PNP), NJL21194DG (NPN)

ELECTRICAL CHARACTERISTICS (T_C = 25°C unless otherwise noted)

Characteristic	Symbol	Min	Max	Unit
----------------	--------	-----	-----	------

OFF CHARACTERISTICS

Collector–Emitter Sustaining Voltage (I _C = 100 mAdc, I _B = 0)	V _{CEO(sus)}	250	–	Vdc
Collector Cutoff Current (V _{CE} = 200 Vdc, I _B = 0)	I _{CEO}	–	100	μAdc
Emitter Cutoff Current (V _{CE} = 5 Vdc, I _C = 0)	I _{EBO}	–	100	μAdc
Collector Cutoff Current (V _{CE} = 250 Vdc, V _{BE(off)} = 1.5 Vdc)	I _{CEX}	–	100	μAdc

SECOND BREAKDOWN

Second Breakdown Collector Current with Base Forward Biased (V _{CE} = 50 Vdc, t = 1 s (non-repetitive)) (V _{CE} = 80 Vdc, t = 1 s (non-repetitive))	I _{S/b}	4.0 2.25	– –	Adc
---	------------------	-------------	--------	-----

ON CHARACTERISTICS

DC Current Gain (I _C = 8 Adc, V _{CE} = 5 Vdc) (I _C = 16 Adc, I _B = 5 Adc)	h _{FE}	25 8	75 –	
Base–Emitter On Voltage (I _C = 8 Adc, V _{CE} = 5 Vdc)	V _{BE(on)}	–	2.2	Vdc
Collector–Emitter Saturation Voltage (I _C = 8 Adc, I _B = 0.8 Adc) (I _C = 16 Adc, I _B = 3.2 Adc)	V _{CE(sat)}	– –	1.4 4	Vdc

DYNAMIC CHARACTERISTICS

Total Harmonic Distortion at the Output V _{RMS} = 28.3 V, f = 1 kHz, P _{LOAD} = 100 W _{RMS} (Matched pair h _{FE} = 50 @ 5 A/5 V)	T _{HD}	h _{FE} unmatched h _{FE} matched	– – –	%
Current Gain Bandwidth Product (I _C = 1 Adc, V _{CE} = 10 Vdc, f _{test} = 1 MHz)	f _T	4	–	MHz
Output Capacitance (V _{CB} = 10 Vdc, I _E = 0, f _{test} = 1 MHz)	C _{ob}	–	500	pF
Maximum Instantaneous Forward Voltage (Note 2) (I _F = 1.0 A, T _J = 25°C) (I _F = 1.0 A, T _J = 150°C)	V _F		1.1 0.93	V
Maximum Instantaneous Reverse Current (Note 2) (Rated dc Voltage, T _J = 25°C) (Rated dc Voltage, T _J = 150°C)	i _R		10 100	μA
Maximum Reverse Recovery Time (I _F = 1.0 A, di/dt = 50 A/μs)	t _{rr}		100	ns

2. Diode Pulse Test: Pulse Width = 300 μs, Duty Cycle ≤ 2.0%.

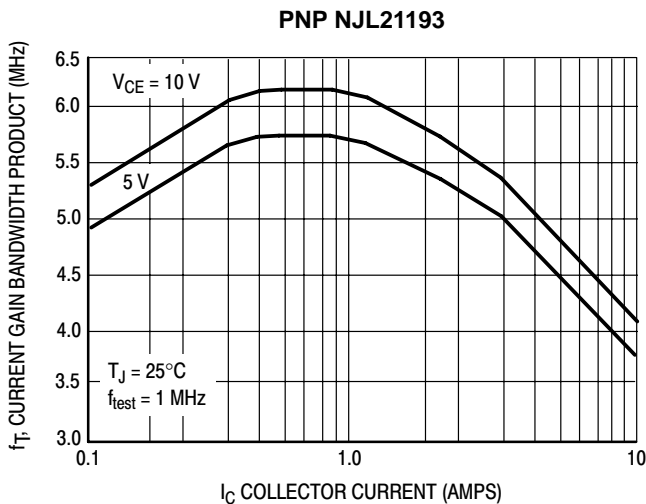

Figure 1. Typical Current Gain Bandwidth Product

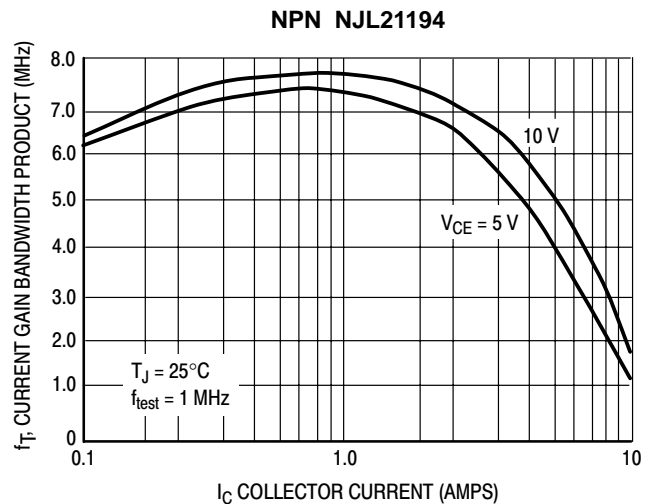

Figure 2. Typical Current Gain Bandwidth Product

NJL21193DG (PNP), NJL21194DG (NPN)

TYPICAL CHARACTERISTICS

PNP NJL21193

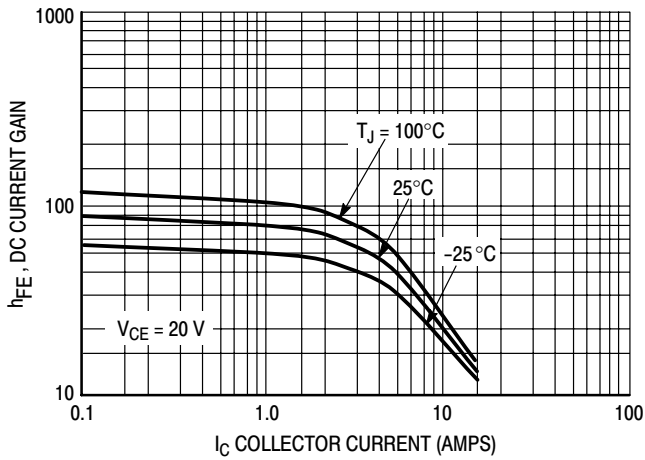

Figure 3. DC Current Gain, $V_{CE} = 20\text{ V}$

NPN NJL21194

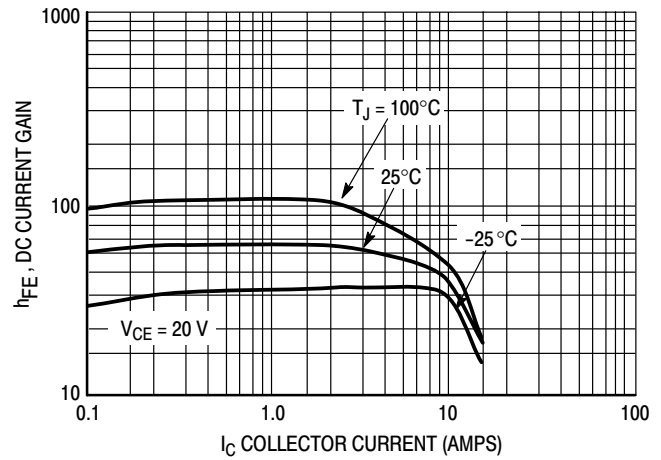

Figure 4. DC Current Gain, $V_{CE} = 20\text{ V}$

PNP NJL21193

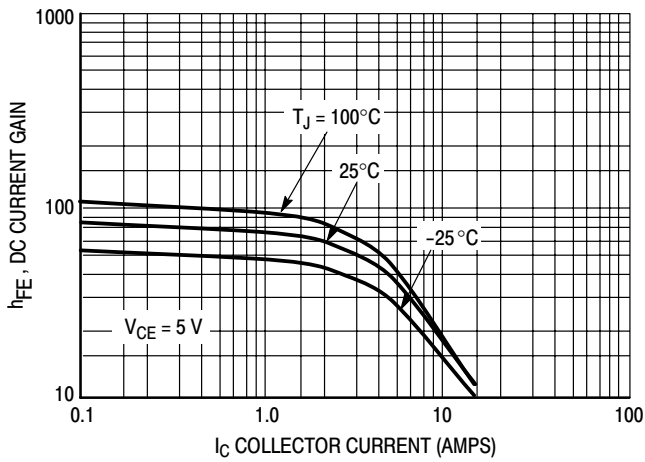

Figure 5. DC Current Gain, $V_{CE} = 5\text{ V}$

NPN NJL21194

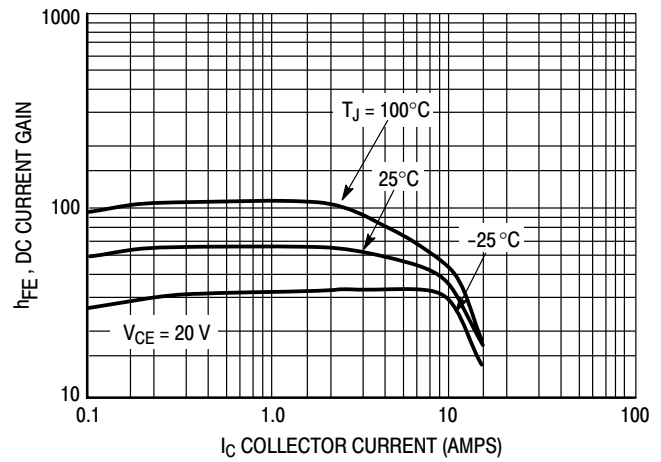
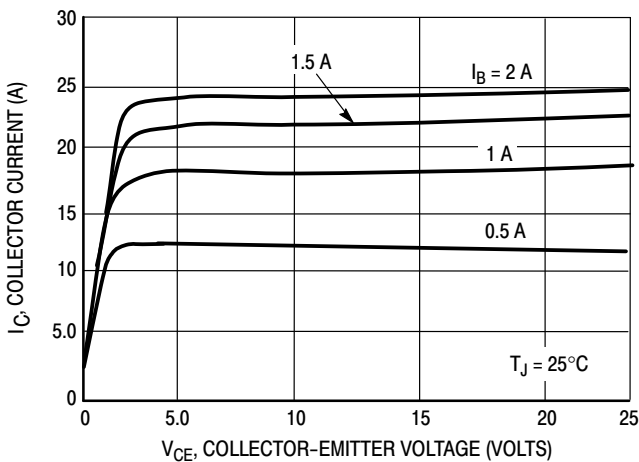
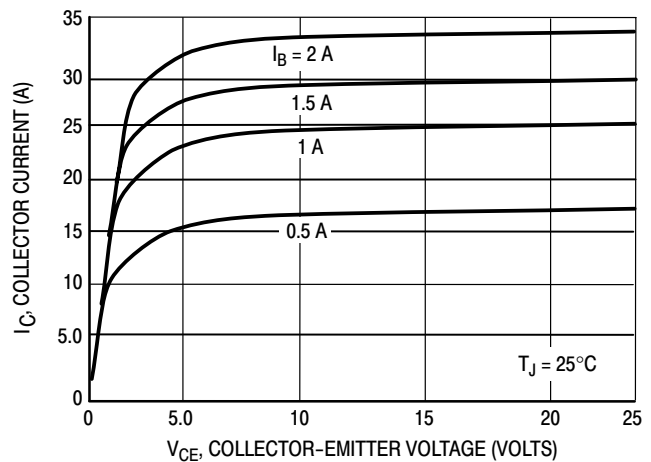

Figure 6. DC Current Gain, $V_{CE} = 5\text{ V}$

PNP NJL21193



NPN NJL21194



NJL21193DG (PNP), NJL21194DG (NPN)

TYPICAL CHARACTERISTICS

PNP NJL21193

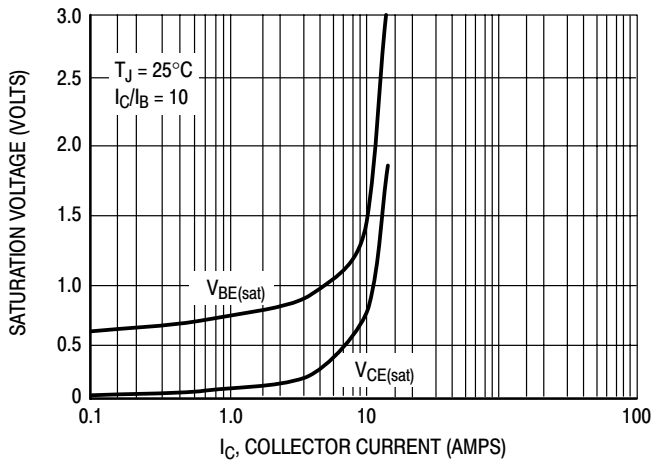

Figure 9. Typical Saturation Voltages

NPN NJL21194

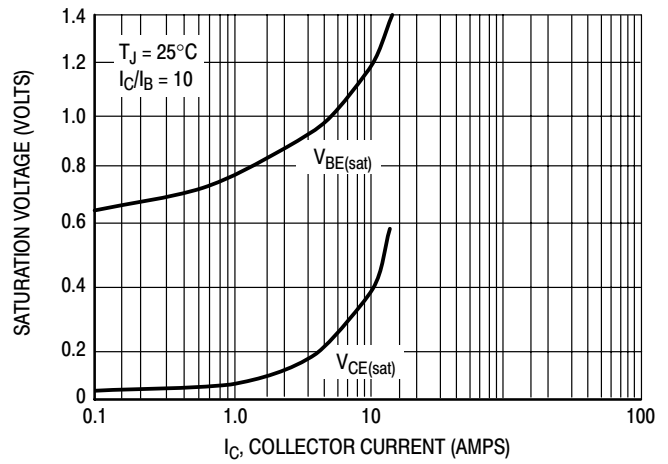

Figure 10. Typical Saturation Voltages

PNP NJL21193

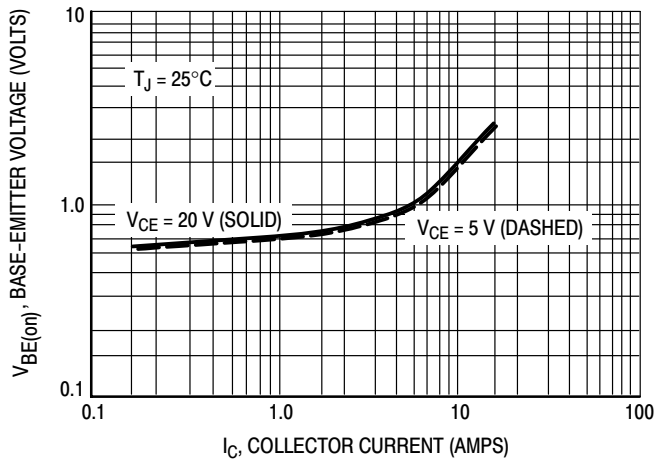

Figure 11. Typical Base-Emitter Voltage

NPN NJL21194

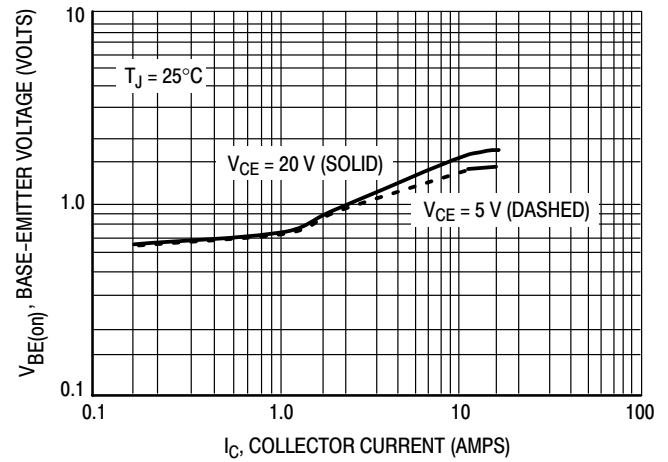

Figure 12. Typical Base-Emitter Voltage

NJL21193DG (PNP), NJL21194DG (NPN)

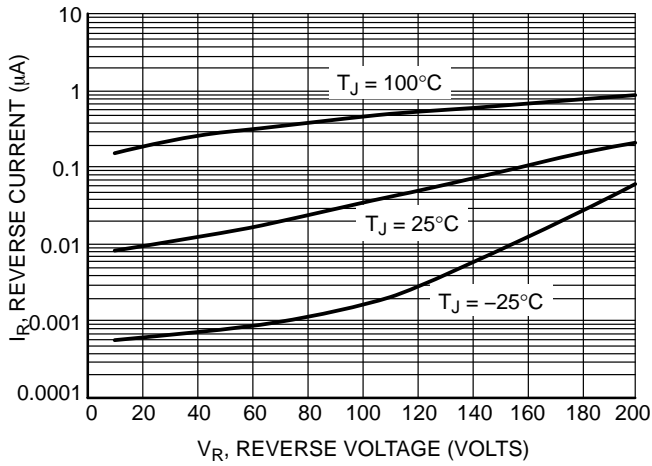

Figure 13. Typical Reverse Current

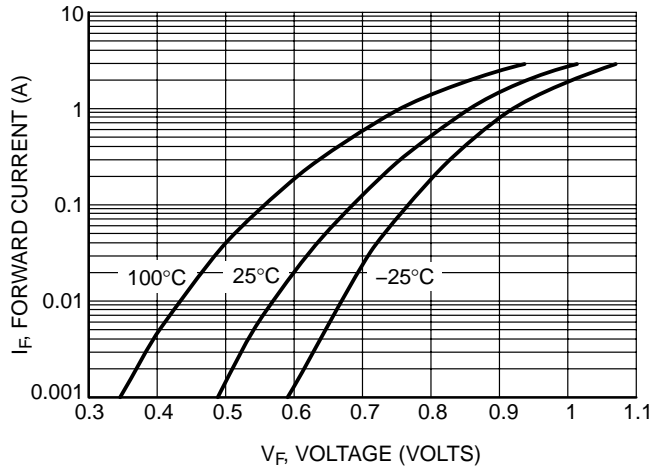

Figure 14. Typical Forward Voltage

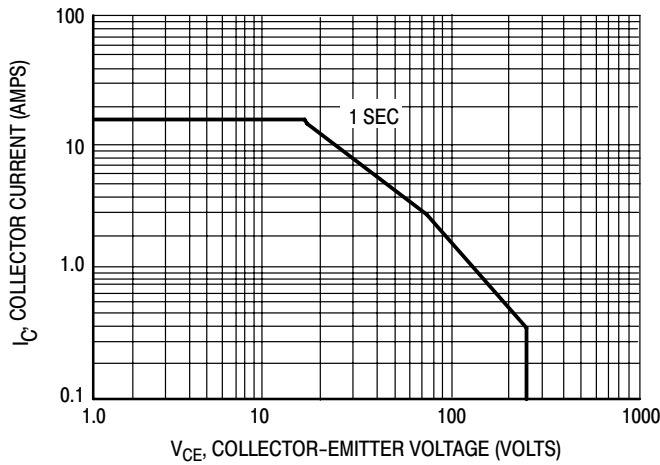

Figure 15. Active Region Safe Operating Area

There are two limitations on the power handling ability of a transistor; average junction temperature and secondary breakdown. Safe operating area curves indicate $I_C - V_{CE}$ limits of the transistor that must be observed for reliable operation; i.e., the transistor must not be subjected to greater dissipation than the curves indicate.

The data of Figure 15 is based on $T_{J(pk)} = 150^\circ\text{C}$; T_C is variable depending on conditions. At high case temperatures, thermal limitations will reduce the power than can be handled to values less than the limitations imposed by second breakdown.

NJL21193DG (PNP), NJL21194DG (NPN)

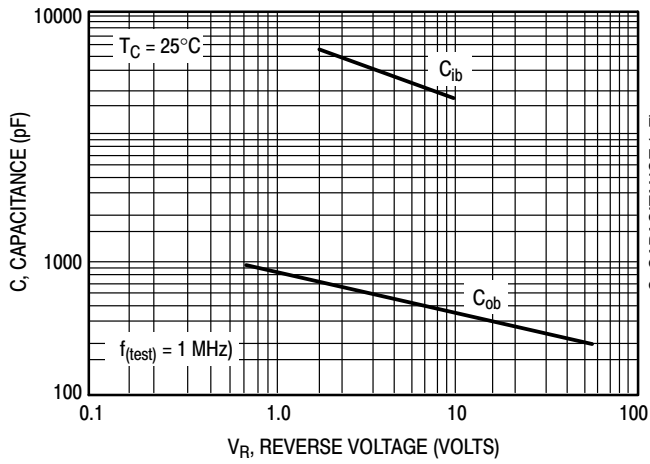

Figure 16. NJL21193 Typical Capacitance

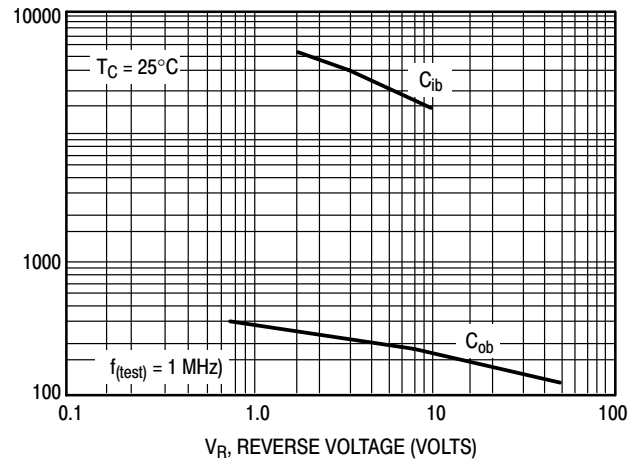

Figure 17. NJL21194 Typical Capacitance

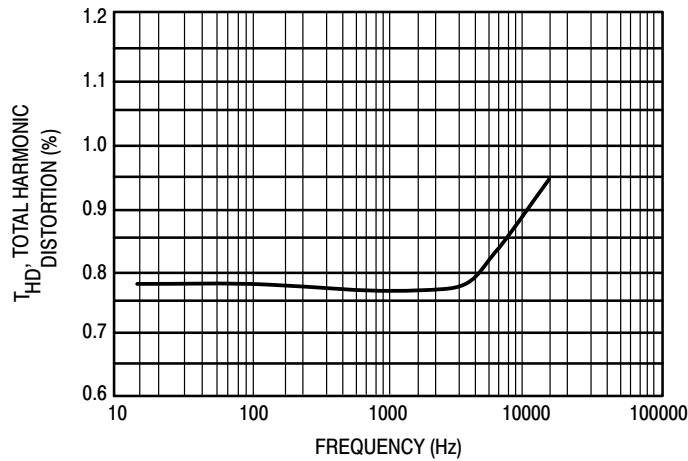

Figure 18. Typical Total Harmonic Distortion

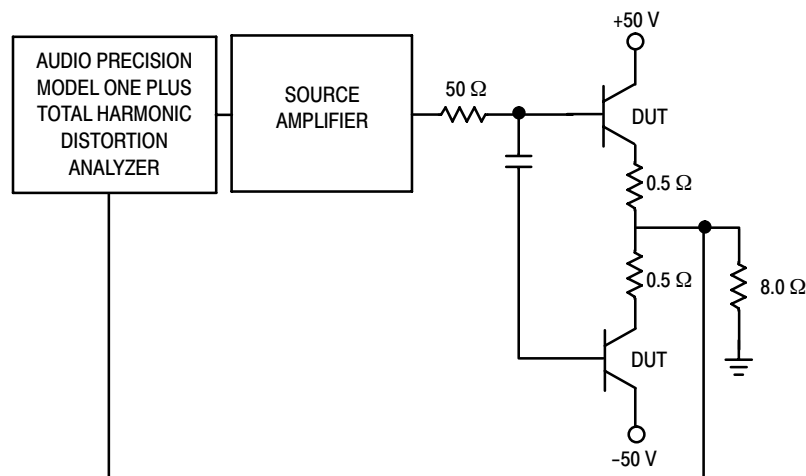
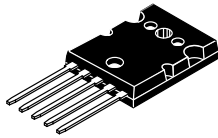

Figure 19. Total Harmonic Distortion Test Circuit



TO-264, 5-LEAD
CASE 340AA
ISSUE A

DATE 04 FEB 2013

SCALE 1:2

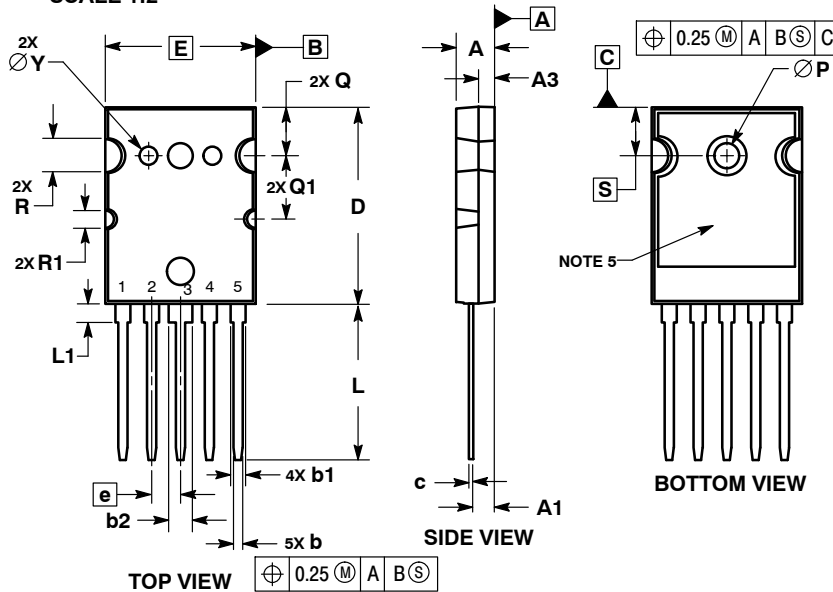

NOTES:

1. DIMENSIONING AND TOLERANCING PER ASME Y14.5M, 1994.
2. CONTROLLING DIMENSION: MILLIMETERS.
3. DIMENSION b APPLIES BETWEEN 2.50 AND 3.81 FROM THE LEAD TIP.
4. DIMENSION S APPLIES TO THE MOUNTING HOLE (∅P). DIMENSION Q APPLIES TO THE NOTCHES (2X R).
5. THERMAL PAD SIZE AND SHAPE MAY VARY WITHIN THE AREA DEFINED BY DIMENSIONS D AND E.

DIM	MILLIMETERS	
	MIN	MAX
A	4.70	5.31
A1	2.50	3.10
A3	2.00 REF	
b	1.10	1.50
b1	2.00 REF	
b2	3.00 REF	
c	0.43	0.74
D	25.58	26.59
E	19.30	20.29
e	3.81 BSC	
L	19.79	21.39
L1	2.10	2.30
P	3.00	3.51
Q	5.80	6.20
Q1	8.80	9.20
R	4.00 REF	
R1	2.00 REF	
S	9.00 BSC	
Y	1.80 REF	

- STYLE 1:
PIN 1. BASE
2. EMITTER
3. COLLECTOR
4. ANODE
5. CATHODE

GENERIC
MARKING DIAGRAM*

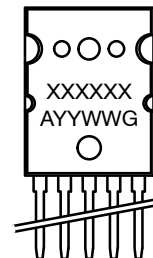

- XXXXXX = Specific Device Code
- A = Assembly Location
- YY = Year
- WW = Work Week
- G = Pb-Free Package

*This information is generic. Please refer to device data sheet for actual part marking. Pb-Free indicator, "G" or microdot "▪", may or may not be present.

DOCUMENT NUMBER:	98AON19871D	Electronic versions are uncontrolled except when accessed directly from the Document Repository. Printed versions are uncontrolled except when stamped "CONTROLLED COPY" in red.
DESCRIPTION:	TO-264, 5-LEAD	PAGE 1 OF 1

onsemi and ONSEMI are trademarks of Semiconductor Components Industries, LLC dba onsemi or its subsidiaries in the United States and/or other countries. onsemi reserves the right to make changes without further notice to any products herein. onsemi makes no warranty, representation or guarantee regarding the suitability of its products for any particular purpose, nor does onsemi assume any liability arising out of the application or use of any product or circuit, and specifically disclaims any and all liability, including without limitation special, consequential or incidental damages. onsemi does not convey any license under its patent rights nor the rights of others.

onsemi, **Onsemi**, and other names, marks, and brands are registered and/or common law trademarks of Semiconductor Components Industries, LLC dba "**onsemi**" or its affiliates and/or subsidiaries in the United States and/or other countries. **onsemi** owns the rights to a number of patents, trademarks, copyrights, trade secrets, and other intellectual property. A listing of **onsemi**'s product/patent coverage may be accessed at www.onsemi.com/site/pdf/Patent-Marking.pdf. **onsemi** reserves the right to make changes at any time to any products or information herein, without notice. The information herein is provided "as-is" and **onsemi** makes no warranty, representation or guarantee regarding the accuracy of the information, product features, availability, functionality, or suitability of its products for any particular purpose, nor does **onsemi** assume any liability arising out of the application or use of any product or circuit, and specifically disclaims any and all liability, including without limitation special, consequential or incidental damages. Buyer is responsible for its products and applications using **onsemi** products, including compliance with all laws, regulations and safety requirements or standards, regardless of any support or applications information provided by **onsemi**. "Typical" parameters which may be provided in **onsemi** data sheets and/or specifications can and do vary in different applications and actual performance may vary over time. All operating parameters, including "Typicals" must be validated for each customer application by customer's technical experts. **onsemi** does not convey any license under any of its intellectual property rights nor the rights of others. **onsemi** products are not designed, intended, or authorized for use as a critical component in life support systems or any FDA Class 3 medical devices or medical devices with a same or similar classification in a foreign jurisdiction or any devices intended for implantation in the human body. Should Buyer purchase or use **onsemi** products for any such unintended or unauthorized application, Buyer shall indemnify and hold **onsemi** and its officers, employees, subsidiaries, affiliates, and distributors harmless against all claims, costs, damages, and expenses, and reasonable attorney fees arising out of, directly or indirectly, any claim of personal injury or death associated with such unintended or unauthorized use, even if such claim alleges that **onsemi** was negligent regarding the design or manufacture of the part. **onsemi** is an Equal Opportunity/Affirmative Action Employer. This literature is subject to all applicable copyright laws and is not for resale in any manner.

ADDITIONAL INFORMATION

TECHNICAL PUBLICATIONS:

Technical Library: www.onsemi.com/design/resources/technical-documentation
onsemi Website: www.onsemi.com

ONLINE SUPPORT: www.onsemi.com/support

For additional information, please contact your local Sales Representative at www.onsemi.com/support/sales