

NE521

High-Speed Dual-Differential Comparator/Sense Amp

Features

- TTL-Compatible Strobes and Outputs
- Large Common-Mode Input Voltage Range
- Operates from Standard Supply Voltages
- Pb-Free Packages are Available

Applications

- MOS Memory Sense Amp
- A-to-D Conversion
- High-Speed Line Receiver

MAXIMUM RATINGS

Rating	Symbol	Value	Unit	
Supply Voltage Positive Negative	V+ V-	+7.0 -7.0	V	
Differential Input Voltage	V _{IDR}	±6.0	V	
Input Voltage Common Mode Strobe/Gate	V _{IN}	±5.0 +5.25	V	
Maximum Power Dissipation (Note 1) T _A = 25°C (Still-Air)	P _D	N Package D Package	1420 1040	mW
Thermal Resistance, Junction-to-Ambient N Package D Package	R _{θJA}	100 145	°C/W	
Operating Temperature Range	T _A	0 to 70	°C	
Storage Temperature Range	T _{stg}	-65 to +150	°C	
Operating Junction Temperature	T _J	150	°C	
Lead Soldering Temperature (10 sec max)	T _{slid}	+230	°C	

Stresses exceeding Maximum Ratings may damage the device. Maximum Ratings are stress ratings only. Functional operation above the Recommended Operating Conditions is not implied. Extended exposure to stresses above the Recommended Operating Conditions may affect device reliability.

1. Derate above 25°C at the following rates:

- N package at 10 mW/°C
- D package at 6.9 mW/°C.



ON Semiconductor®

<http://onsemi.com>

MARKING DIAGRAMS

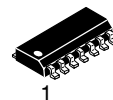

SOIC-14
D SUFFIX
CASE 751A

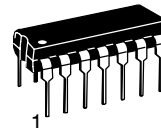

PDIP-14
N SUFFIX
CASE 646



A = Assembly Location
WL = Wafer Lot
Y, YY = Year
WW = Work Week
G = Pb-Free Package

PIN CONNECTIONS

D, N Packages

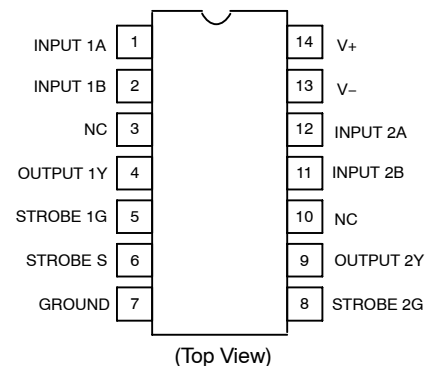

ORDERING INFORMATION

See detailed ordering and shipping information in the package dimensions section on page 5 of this data sheet.

NE521

LOGIC FUNCTION TABLE

$V_{ID} (A^+, B)$	Strobe S	Strobe G	Output (Y)
$V_{ID} \leq -V_{OS}$	H	H	L
$-V_{OS} < V_{ID} < V_{OS}$	H	H	Undefined
$V_{ID} \geq V_{OS}$	H	H	H
X	L	X	H
X	X	L	H

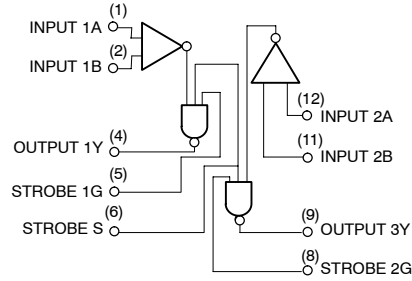

Figure 1. Block Diagram

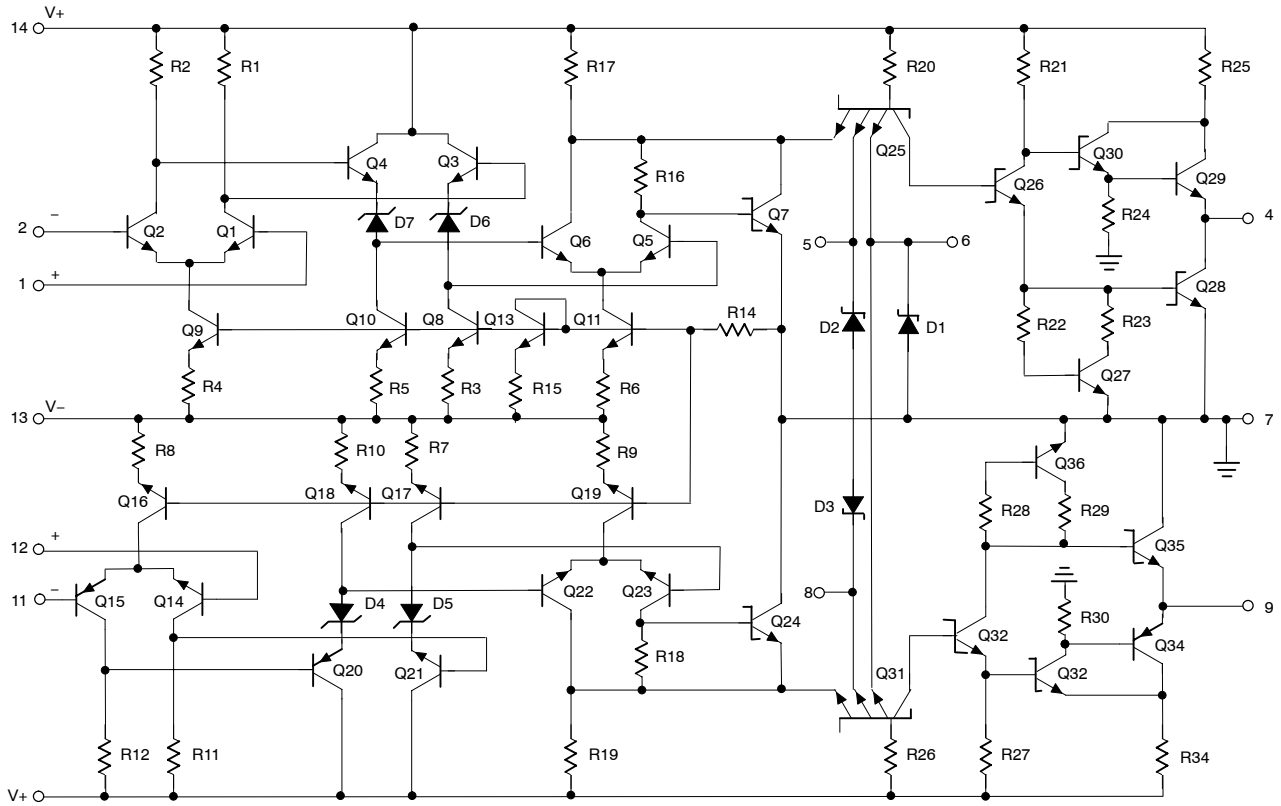

Figure 2. Equivalent Schematic

NE521

DC ELECTRICAL CHARACTERISTICS ($V_+ = +5.0\text{ V}$; $V_- = -5.0\text{ V}$, $T_A = 0^\circ\text{C}$ to $+70^\circ\text{C}$, unless otherwise noted.)

Characteristic	Test Conditions	Symbol	Limits			Unit
			Min	Typ	Max	
Input Offset Voltage At 25°C Overtemperature Range	$V_+ = +4.75\text{ V}$; $V_- = -4.75\text{ V}$	V_{OS}	– –	6.0 –	7.5 10	mV
Input Bias Current At 25°C Overtemperature Range	$V_+ = +5.25\text{ V}$; $V_- = -5.25\text{ V}$	I_{BIAS}	– –	7.5 –	20 40	μA
Input Offset Current At 25°C Overtemperature Range	$V_+ = +5.25\text{ V}$; $V_- = -5.25\text{ V}$	I_{OS}	– –	1.0 –	5.0 12	μA
Common-Mode Voltage Range	$V_+ = +4.75\text{ V}$; $V_- = -4.75\text{ V}$	V_{CM}	–3.0	–	+3.0	V
Input Current High	$V_+ = +5.25\text{ V}$; $V_- = -5.25\text{ V}$ $V_{IH} = 2.7\text{ V}$ 1G or 2G Strobe Common Strobe S	I_{IH}	– –	– –	50 100	μA
Input Current Low	$V_{IL} = 0.5\text{ V}$ 1G or 2G Strobe Common Strobe S	I_{IL}	– –	– –	–2.0 –4.0	mA
Output Voltage High	$V_{I(S)} = 2.0\text{ V}$ $V_+ = +4.75\text{ V}$; $V_- = -4.75\text{ V}$; $I_{LOAD} = -1.0\text{ mA}$	V_{OH}	2.7	3.4		V
Output Voltage Low	$V_+ = +5.25\text{ V}$; $V_- = -5.25\text{ V}$; $I_{LOAD} = 20\text{ mA}$	V_{OL}			0.5	V
Supply Voltage Positive	–	V_+	4.75	5.0	5.25	V
Supply Voltage Negative	–	V_-	–4.75	–5.0	–5.25	V
Supply Current Positive	$V_+ = +5.25\text{ V}$; $V_- = -5.25\text{ V}$; $T_A = 25^\circ\text{C}$	I_{CC+}	–	27	35	mA
Supply Current Negative		I_{CC-}	–	–15	–28	mA
Short-Circuit Output Current	–	I_{SC}	–40	–	–100	mA

AC ELECTRICAL CHARACTERISTICS ($T_A = 25^\circ\text{C}$; $R_L = 280\ \Omega$; $C_L = 15\text{ pF}$, $V_+ = 5.0\text{ V}$; $V_- = 5.0\text{ V}$, guaranteed by characterization)

Characteristic	From Input	To Output	Symbol	Limits			Unit
				Min	Typ	Max	
Large-Signal Switching Speed							
Propagation Delay Low to High (Note 2)	Amp	Output	$t_{PLH(D)}$	–	9.6	12	ns
High to Low (Note 2)	Amp	Output	$t_{PHL(D)}$	–	8.2	9.0	
Low to High (Note 3)	Strobe	Output	$t_{PLH(S)}$	–	4.8	10	
High to Low (Note 3)	Strobe	Output	$t_{PHL(S)}$	–	3.9	6.0	
Max. Operating Frequency	–	–	f_{MAX}	40	55	–	MHz

2. Response time measured from 0 V point of $\pm 100\text{ mV}_{P-P}$ 10 MHz square wave to the 1.5 V point of the output.

3. Response time measured from 1.5 V point of input to 1.5 V point of the output.

TYPICAL PERFORMANCE CHARACTERISTICS

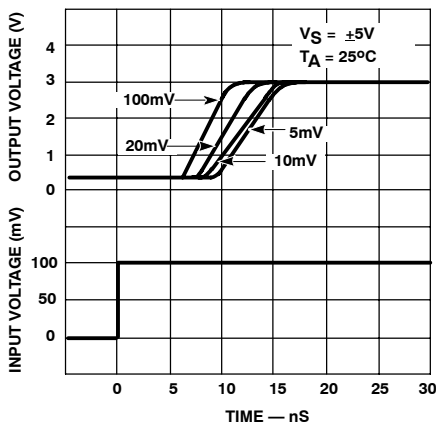

Figure 3. Response Time for Various Input Overdrives

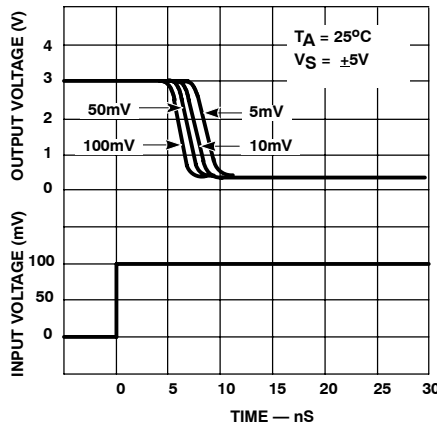

Figure 4. Response Time for Various Input Overdrives

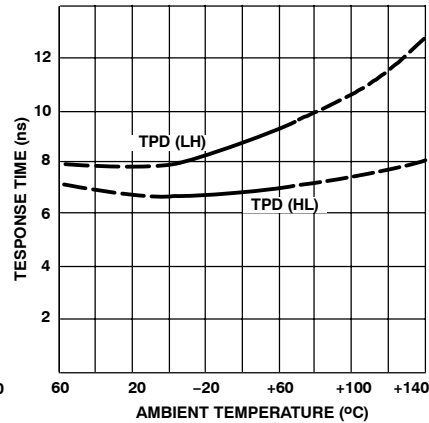

Figure 5. Response Time vs. Temperature

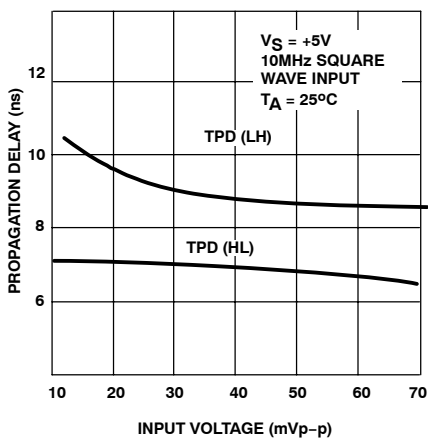

Figure 6. Propagation Delay for Various Input Voltages

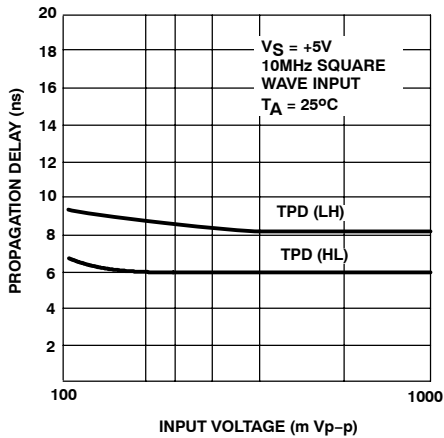

Figure 7. Propagation Delay for Various Input Voltages

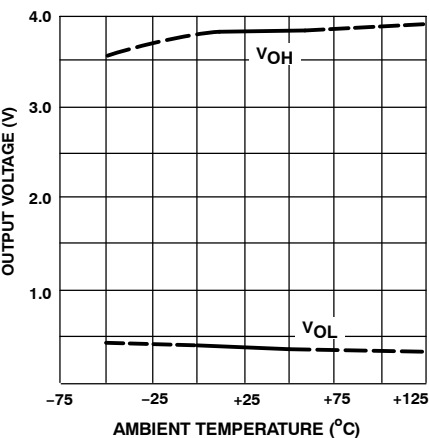

Figure 8. Output Voltage vs. Ambient Temperature

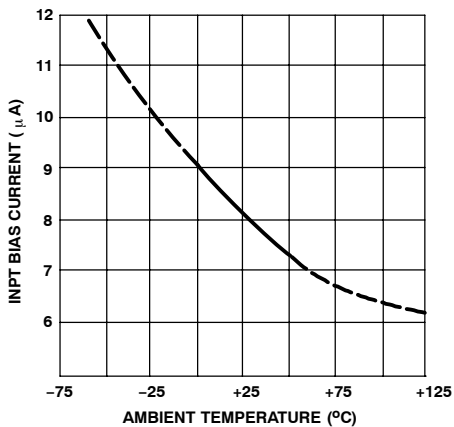

Figure 9. Input Bias Current vs. Ambient Temperature

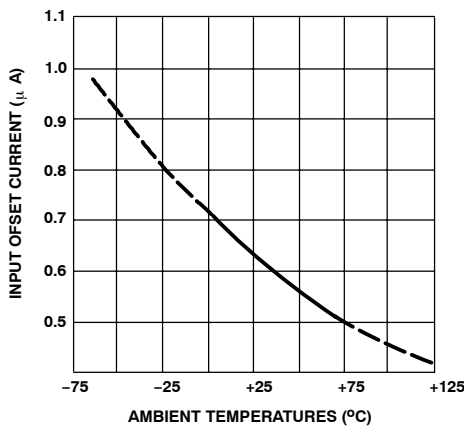

Figure 10. Input Offset Current vs. Ambient Temperature

NE521

ORDERING INFORMATION

Device	Temperature Range	Package	Shipping†
NE521D	0 to +70°C	SOIC-14	55 Units/Rail
NE521DG		SOIC-14 (Pb-Free)	
NE521DR2		SOIC-14	2500/Tape & Reel
NE521DR2G		SOIC-14 (Pb-Free)	
NE521N		PDIP-14	25 Units/Rail
NE521NG		PDIP-14 (Pb-Free)	

†For information on tape and reel specifications, including part orientation and tape sizes, please refer to our Tape and Reel Packaging Specification Brochure, BRD8011/D.

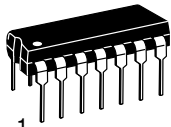

1
SCALE 1:1

PDIP-14
CASE 646-06
ISSUE 5

DATE 22 APR 2015

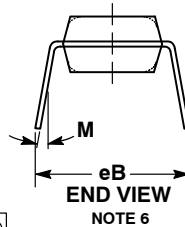
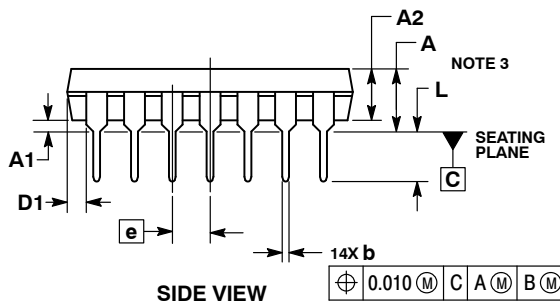
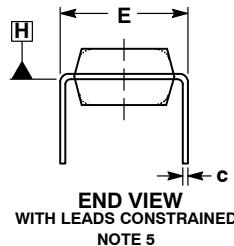
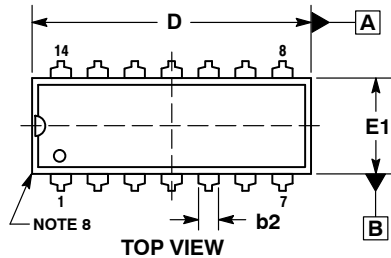

- NOTES:
1. DIMENSIONING AND TOLERANCING PER ASME Y14.5M, 1994.
 2. CONTROLLING DIMENSION: INCHES.
 3. DIMENSIONS A, A1 AND L ARE MEASURED WITH THE PACKAGE SEATED IN JEDEC SEATING PLANE GAUGE GS-3.
 4. DIMENSIONS D, D1 AND E1 DO NOT INCLUDE MOLD FLASH OR PROTRUSIONS. MOLD FLASH OR PROTRUSIONS ARE NOT TO EXCEED 0.10 INCH.
 5. DIMENSION E IS MEASURED AT A POINT 0.015 BELOW DATUM PLANE H WITH THE LEADS CONSTRAINED PERPENDICULAR TO DATUM C.
 6. DIMENSION eB IS MEASURED AT THE LEAD TIPS WITH THE LEADS UNCONSTRAINED.
 7. DATUM PLANE H IS COINCIDENT WITH THE BOTTOM OF THE LEADS, WHERE THE LEADS EXIT THE BODY.
 8. PACKAGE CONTOUR IS OPTIONAL (ROUNDED OR SQUARE CORNERS).

DIM	INCHES		MILLIMETERS	
	MIN	MAX	MIN	MAX
A	---	0.210	---	5.33
A1	0.015	---	0.38	---
A2	0.115	0.195	2.92	4.95
b	0.014	0.022	0.35	0.56
b2	0.060 TYP 1.52 TYP			
C	0.008	0.014	0.20	0.36
D	0.735	0.775	18.67	19.69
D1	0.005	---	0.13	---
E	0.300	0.325	7.62	8.26
E1	0.240	0.280	6.10	7.11
e	0.100 BSC 2.54 BSC			
eB	---	0.430	---	10.92
L	0.115	0.150	2.92	3.81
M	---	10°	---	10°

GENERIC
MARKING DIAGRAM*

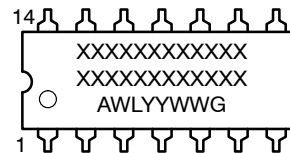

- XXXXX = Specific Device Code
- A = Assembly Location
- WL = Wafer Lot
- YY = Year
- WW = Work Week
- G = Pb-Free Package

*This information is generic. Please refer to device data sheet for actual part marking. Pb-Free indicator, "G" or microdot "•", may or may not be present. Some products may not follow the Generic Marking.

STYLES ON PAGE 2

DOCUMENT NUMBER:	98ASB42428B	Electronic versions are uncontrolled except when accessed directly from the Document Repository. Printed versions are uncontrolled except when stamped "CONTROLLED COPY" in red.
DESCRIPTION:	PDIP-14	PAGE 1 OF 2

onsemi and ONSEMI are trademarks of Semiconductor Components Industries, LLC dba onsemi or its subsidiaries in the United States and/or other countries. onsemi reserves the right to make changes without further notice to any products herein. onsemi makes no warranty, representation or guarantee regarding the suitability of its products for any particular purpose, nor does onsemi assume any liability arising out of the application or use of any product or circuit, and specifically disclaims any and all liability, including without limitation special, consequential or incidental damages. onsemi does not convey any license under its patent rights nor the rights of others.

PDIP-14
CASE 646-06
ISSUE S

DATE 22 APR 2015

STYLE 1:
 PIN 1. COLLECTOR
 2. BASE
 3. EMITTER
 4. NO
 CONNECTION
 5. EMITTER
 6. BASE
 7. COLLECTOR
 8. COLLECTOR
 9. BASE
 10. EMITTER
 11. NO
 CONNECTION
 12. EMITTER
 13. BASE
 14. COLLECTOR

STYLE 2:
 CANCELLED

STYLE 3:
 CANCELLED

STYLE 4:
 PIN 1. DRAIN
 2. SOURCE
 3. GATE
 4. NO
 CONNECTION
 5. GATE
 6. SOURCE
 7. DRAIN
 8. DRAIN
 9. SOURCE
 10. GATE
 11. NO
 CONNECTION
 12. GATE
 13. SOURCE
 14. DRAIN

STYLE 5:
 PIN 1. GATE
 2. DRAIN
 3. SOURCE
 4. NO CONNECTION
 5. SOURCE
 6. DRAIN
 7. GATE
 8. GATE
 9. DRAIN
 10. SOURCE
 11. NO CONNECTION
 12. SOURCE
 13. DRAIN
 14. GATE

STYLE 6:
 PIN 1. COMMON CATHODE
 2. ANODE/CATHODE
 3. ANODE/CATHODE
 4. NO CONNECTION
 5. ANODE/CATHODE
 6. NO CONNECTION
 7. ANODE/CATHODE
 8. ANODE/CATHODE
 9. ANODE/CATHODE
 10. NO CONNECTION
 11. ANODE/CATHODE
 12. ANODE/CATHODE
 13. NO CONNECTION
 14. COMMON ANODE

STYLE 7:
 PIN 1. NO CONNECTION
 2. ANODE
 3. ANODE
 4. NO CONNECTION
 5. ANODE
 6. NO CONNECTION
 7. ANODE
 8. ANODE
 9. ANODE
 10. NO CONNECTION
 11. ANODE
 12. ANODE
 13. NO CONNECTION
 14. COMMON
 CATHODE

STYLE 8:
 PIN 1. NO CONNECTION
 2. CATHODE
 3. CATHODE
 4. NO CONNECTION
 5. CATHODE
 6. NO CONNECTION
 7. CATHODE
 8. CATHODE
 9. CATHODE
 10. NO CONNECTION
 11. CATHODE
 12. CATHODE
 13. NO CONNECTION
 14. COMMON ANODE

STYLE 9:
 PIN 1. COMMON CATHODE
 2. ANODE/CATHODE
 3. ANODE/CATHODE
 4. NO CONNECTION
 5. ANODE/CATHODE
 6. ANODE/CATHODE
 7. COMMON ANODE
 8. COMMON ANODE
 9. ANODE/CATHODE
 10. ANODE/CATHODE
 11. NO CONNECTION
 12. ANODE/CATHODE
 13. ANODE/CATHODE
 14. COMMON CATHODE

STYLE 10:
 PIN 1. COMMON
 CATHODE
 2. ANODE/CATHODE
 3. ANODE/CATHODE
 4. ANODE/CATHODE
 5. ANODE/CATHODE
 6. NO CONNECTION
 7. COMMON ANODE
 8. COMMON
 CATHODE
 9. ANODE/CATHODE
 10. ANODE/CATHODE
 11. ANODE/CATHODE
 12. ANODE/CATHODE
 13. NO CONNECTION
 14. COMMON ANODE

STYLE 11:
 PIN 1. CATHODE
 2. CATHODE
 3. CATHODE
 4. CATHODE
 5. CATHODE
 6. CATHODE
 7. CATHODE
 8. ANODE
 9. ANODE
 10. ANODE
 11. ANODE
 12. ANODE
 13. ANODE
 14. ANODE

STYLE 12:
 PIN 1. COMMON CATHODE
 2. COMMON ANODE
 3. ANODE/CATHODE
 4. ANODE/CATHODE
 5. ANODE/CATHODE
 6. COMMON ANODE
 7. COMMON CATHODE
 8. ANODE/CATHODE
 9. ANODE/CATHODE
 10. ANODE/CATHODE
 11. ANODE/CATHODE
 12. ANODE/CATHODE
 13. ANODE/CATHODE
 14. ANODE/CATHODE

DOCUMENT NUMBER:	98ASB42428B	Electronic versions are uncontrolled except when accessed directly from the Document Repository. Printed versions are uncontrolled except when stamped "CONTROLLED COPY" in red.
DESCRIPTION:	PDIP-14	PAGE 2 OF 2

onsemi and **ONSEMI** are trademarks of Semiconductor Components Industries, LLC dba **onsemi** or its subsidiaries in the United States and/or other countries. **onsemi** reserves the right to make changes without further notice to any products herein. **onsemi** makes no warranty, representation or guarantee regarding the suitability of its products for any particular purpose, nor does **onsemi** assume any liability arising out of the application or use of any product or circuit, and specifically disclaims any and all liability, including without limitation special, consequential or incidental damages. **onsemi** does not convey any license under its patent rights nor the rights of others.

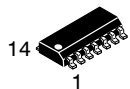

SCALE 1:1

SOIC-14 NB
CASE 751A-03
ISSUE L

DATE 03 FEB 2016

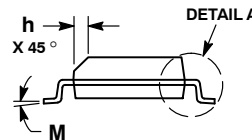
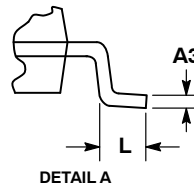
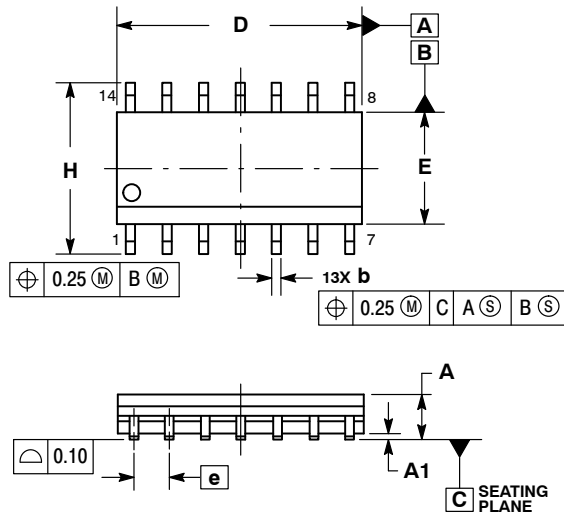

NOTES:

1. DIMENSIONING AND TOLERANCING PER ASME Y14.5M, 1994.
2. CONTROLLING DIMENSION: MILLIMETERS.
3. DIMENSION b DOES NOT INCLUDE DAMBAR PROTRUSION. ALLOWABLE PROTRUSION SHALL BE 0.13 TOTAL IN EXCESS OF AT MAXIMUM MATERIAL CONDITION.
4. DIMENSIONS D AND E DO NOT INCLUDE MOLD PROTRUSIONS.
5. MAXIMUM MOLD PROTRUSION 0.15 PER SIDE.

DIM	MILLIMETERS		INCHES	
	MIN	MAX	MIN	MAX
A	1.35	1.75	0.054	0.068
A1	0.10	0.25	0.004	0.010
A3	0.19	0.25	0.008	0.010
b	0.35	0.49	0.014	0.019
D	8.55	8.75	0.337	0.344
E	3.80	4.00	0.150	0.157
e	1.27 BSC		0.050 BSC	
H	5.80	6.20	0.228	0.244
h	0.25	0.50	0.010	0.019
L	0.40	1.25	0.016	0.049
M	0°	7°	0°	7°

SOLDERING FOOTPRINT*

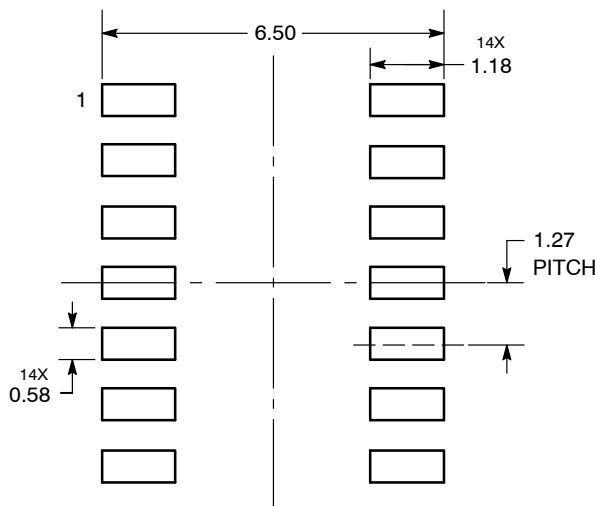

DIMENSIONS: MILLIMETERS

*For additional information on our Pb-Free strategy and soldering details, please download the onsemi Soldering and Mounting Techniques Reference Manual, SOLDERRM/D.

GENERIC MARKING DIAGRAM*

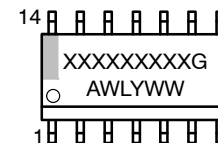

- XXXXXX = Specific Device Code
- A = Assembly Location
- WL = Wafer Lot
- Y = Year
- WW = Work Week
- G = Pb-Free Package

*This information is generic. Please refer to device data sheet for actual part marking. Pb-Free indicator, "G" or microdot "▪", may or may not be present. Some products may not follow the Generic Marking.

STYLES ON PAGE 2

DOCUMENT NUMBER:	98ASB42565B	Electronic versions are uncontrolled except when accessed directly from the Document Repository. Printed versions are uncontrolled except when stamped "CONTROLLED COPY" in red.
DESCRIPTION:	SOIC-14 NB	PAGE 1 OF 2

onsemi and onsemi are trademarks of Semiconductor Components Industries, LLC dba onsemi or its subsidiaries in the United States and/or other countries. onsemi reserves the right to make changes without further notice to any products herein. onsemi makes no warranty, representation or guarantee regarding the suitability of its products for any particular purpose, nor does onsemi assume any liability arising out of the application or use of any product or circuit, and specifically disclaims any and all liability, including without limitation special, consequential or incidental damages. onsemi does not convey any license under its patent rights nor the rights of others.

SOIC-14
CASE 751A-03
ISSUE L

DATE 03 FEB 2016

STYLE 1:
 PIN 1. COMMON CATHODE
 2. ANODE/CATHODE
 3. ANODE/CATHODE
 4. NO CONNECTION
 5. ANODE/CATHODE
 6. NO CONNECTION
 7. ANODE/CATHODE
 8. ANODE/CATHODE
 9. ANODE/CATHODE
 10. NO CONNECTION
 11. ANODE/CATHODE
 12. ANODE/CATHODE
 13. NO CONNECTION
 14. COMMON ANODE

STYLE 2:
 CANCELLED

STYLE 3:
 PIN 1. NO CONNECTION
 2. ANODE
 3. ANODE
 4. NO CONNECTION
 5. ANODE
 6. NO CONNECTION
 7. ANODE
 8. ANODE
 9. ANODE
 10. NO CONNECTION
 11. ANODE
 12. ANODE
 13. NO CONNECTION
 14. COMMON CATHODE

STYLE 4:
 PIN 1. NO CONNECTION
 2. CATHODE
 3. CATHODE
 4. NO CONNECTION
 5. CATHODE
 6. NO CONNECTION
 7. CATHODE
 8. CATHODE
 9. CATHODE
 10. NO CONNECTION
 11. CATHODE
 12. CATHODE
 13. NO CONNECTION
 14. COMMON ANODE

STYLE 5:
 PIN 1. COMMON CATHODE
 2. ANODE/CATHODE
 3. ANODE/CATHODE
 4. ANODE/CATHODE
 5. ANODE/CATHODE
 6. NO CONNECTION
 7. COMMON ANODE
 8. COMMON CATHODE
 9. ANODE/CATHODE
 10. ANODE/CATHODE
 11. ANODE/CATHODE
 12. ANODE/CATHODE
 13. NO CONNECTION
 14. COMMON ANODE

STYLE 6:
 PIN 1. CATHODE
 2. CATHODE
 3. CATHODE
 4. CATHODE
 5. CATHODE
 6. CATHODE
 7. CATHODE
 8. ANODE
 9. ANODE
 10. ANODE
 11. ANODE
 12. ANODE
 13. ANODE
 14. ANODE

STYLE 7:
 PIN 1. ANODE/CATHODE
 2. COMMON ANODE
 3. COMMON CATHODE
 4. ANODE/CATHODE
 5. ANODE/CATHODE
 6. ANODE/CATHODE
 7. ANODE/CATHODE
 8. ANODE/CATHODE
 9. ANODE/CATHODE
 10. ANODE/CATHODE
 11. COMMON CATHODE
 12. COMMON ANODE
 13. ANODE/CATHODE
 14. ANODE/CATHODE

STYLE 8:
 PIN 1. COMMON CATHODE
 2. ANODE/CATHODE
 3. ANODE/CATHODE
 4. NO CONNECTION
 5. ANODE/CATHODE
 6. ANODE/CATHODE
 7. COMMON ANODE
 8. COMMON ANODE
 9. ANODE/CATHODE
 10. ANODE/CATHODE
 11. NO CONNECTION
 12. ANODE/CATHODE
 13. ANODE/CATHODE
 14. COMMON CATHODE

DOCUMENT NUMBER:	98ASB42565B	Electronic versions are uncontrolled except when accessed directly from the Document Repository. Printed versions are uncontrolled except when stamped "CONTROLLED COPY" in red.
DESCRIPTION:	SOIC-14 NB	PAGE 2 OF 2

onsemi and **ONSEMI** are trademarks of Semiconductor Components Industries, LLC dba **onsemi** or its subsidiaries in the United States and/or other countries. **onsemi** reserves the right to make changes without further notice to any products herein. **onsemi** makes no warranty, representation or guarantee regarding the suitability of its products for any particular purpose, nor does **onsemi** assume any liability arising out of the application or use of any product or circuit, and specifically disclaims any and all liability, including without limitation special, consequential or incidental damages. **onsemi** does not convey any license under its patent rights nor the rights of others.

onsemi, **Onsemi**, and other names, marks, and brands are registered and/or common law trademarks of Semiconductor Components Industries, LLC dba "**onsemi**" or its affiliates and/or subsidiaries in the United States and/or other countries. **onsemi** owns the rights to a number of patents, trademarks, copyrights, trade secrets, and other intellectual property. A listing of **onsemi**'s product/patent coverage may be accessed at www.onsemi.com/site/pdf/Patent-Marking.pdf. **onsemi** reserves the right to make changes at any time to any products or information herein, without notice. The information herein is provided "as-is" and **onsemi** makes no warranty, representation or guarantee regarding the accuracy of the information, product features, availability, functionality, or suitability of its products for any particular purpose, nor does **onsemi** assume any liability arising out of the application or use of any product or circuit, and specifically disclaims any and all liability, including without limitation special, consequential or incidental damages. Buyer is responsible for its products and applications using **onsemi** products, including compliance with all laws, regulations and safety requirements or standards, regardless of any support or applications information provided by **onsemi**. "Typical" parameters which may be provided in **onsemi** data sheets and/or specifications can and do vary in different applications and actual performance may vary over time. All operating parameters, including "Typicals" must be validated for each customer application by customer's technical experts. **onsemi** does not convey any license under any of its intellectual property rights nor the rights of others. **onsemi** products are not designed, intended, or authorized for use as a critical component in life support systems or any FDA Class 3 medical devices or medical devices with a same or similar classification in a foreign jurisdiction or any devices intended for implantation in the human body. Should Buyer purchase or use **onsemi** products for any such unintended or unauthorized application, Buyer shall indemnify and hold **onsemi** and its officers, employees, subsidiaries, affiliates, and distributors harmless against all claims, costs, damages, and expenses, and reasonable attorney fees arising out of, directly or indirectly, any claim of personal injury or death associated with such unintended or unauthorized use, even if such claim alleges that **onsemi** was negligent regarding the design or manufacture of the part. **onsemi** is an Equal Opportunity/Affirmative Action Employer. This literature is subject to all applicable copyright laws and is not for resale in any manner.

ADDITIONAL INFORMATION

TECHNICAL PUBLICATIONS:

Technical Library: www.onsemi.com/design/resources/technical-documentation
onsemi Website: www.onsemi.com

ONLINE SUPPORT: www.onsemi.com/support

For additional information, please contact your local Sales Representative at www.onsemi.com/support/sales